

Project Divinity

Authors and Affiliation

Instructor: KangSan Kim

Students: SeungHyeon Do (Kongju High School, 12), JaeHun Jang (Korea Science Academy, 12), DongHyun Kim (Korea Science Academy, 12), YongSung Park (GwangJu Munsung High High School, 11), HwanSung Jang (Korean Minjok Leadership Academy, 11)

Table of Contents

Authors and Affiliation	2
List of Figures	8
List of Tables	10
Abbreviations and Terminology	11
1. Introduction	12
1.1. Executive Summary	12
1.2. Background.....	13
1.2.1. Location	13
1.2.1.1. Orbit.....	13
1.2.1.2. Radiation Protection.....	13
1.2.2. Time	15
1.2.3. Background.....	15
1.2.3.1. Propulsion Technologies	15
1.2.3.2. Resource Development.....	16
1.3. Acknowledgements.....	16
2. Structural Design.....	18
2.1. Structural Overview.....	18
2.2. The Torus.....	20
2.3. Spokes.....	25
2.4. Central Hub.....	26
2.5. Industrial Complex	26
2.6. Microgravity Complex.....	26
2.6.1. Wall Materials.....	26
2.6.2. Rotation Mechanism	27
2.7. Assembly Yard	27
2.8. Docking Port.....	28
2.8.1. Docking Mechanism - Railway.....	28
2.8.2. Docking Mechanism – Gears	31
2.9. Debris Shield	32
3. Supporting Infrastructure	36
3.1. Terrestrial Infrastructure.....	36
3.1.1. Launch Vehicles.....	36

3.1.1.1.	Background	36
3.1.1.2.	Staging.....	37
3.1.1.3.	Massive Earth Transfer Vehicle System	38
3.1.2.	Space Cannon.....	40
3.2.	Lunar Infrastructure	42
3.2.1.	Lunar Mass Driver	43
3.2.2.	Lunar Space Elevator Infrastructure	44
3.3.	Asteroidal Infrastructure.....	47
4.	Operations	49
4.1.	Spokes.....	49
4.1.1.1.	Fluid & Energy Transfer	49
4.1.1.2.	Passenger Transfer	49
4.1.1.3.	Cargo Transfer.....	49
4.2.	Central Hub.....	50
4.2.1.	Transport Pods	50
4.2.2.	Transport Arms	50
4.3.	Industrial Complex	50
4.3.1.1.	External Robot Arms.....	51
4.3.1.2.	Compartmentalization	51
4.3.1.3.	Offices and Airlocks.....	51
4.4.	Microgravity Complex.....	52
4.4.1.	Sector I	52
4.4.1.1.	Transport Center.....	52
4.4.1.2.	Low-g Sports Center	52
4.4.1.3.	Starward Hotel.....	53
4.4.1.4.	Oxygen Supply	53
4.4.1.5.	Food Supply	53
4.4.2.	Sector II.....	55
4.4.2.1.	Sports Quarter.....	55
4.4.2.2.	Culture Quarters	55
4.4.2.3.	Tourism Quarter	55
4.4.3.	Sector III	55
4.4.4.	Assembly Yard.....	56

4.4.4.1.	Control Deck	56
4.4.4.2.	External Robotic Arm	57
4.4.4.3.	Airlock.....	57
4.5.	Transportation Complex	57
4.5.1.	Storage Floor.....	57
4.5.2.	Parking Floor.....	57
4.5.3.	Docking Port	57
4.5.3.1.	Docking	57
4.5.3.2.	Docking Administration and Emergency Countermeasures	58
4.5.4.	Nuclear Power Plant.....	59
5.	Human Factors	60
5.1.	Population Distribution.....	60
5.2.	Energy.....	61
5.2.1.	Lighting.....	61
5.2.2.	Electricity.....	61
5.3.	Residential Community	62
5.3.1.	Amenities and Facilities.....	62
5.3.1.1.	Administration.....	62
5.3.1.2.	In-Torus transportation.....	62
5.3.1.3.	Shopping and Consumer Support.....	63
5.3.1.4.	Life Quality	63
5.3.2.	Healthcare and Medication	63
5.3.2.1.	General Healthcare	64
5.3.2.2.	Psychological Health.....	64
5.3.2.3.	Infectious Diseases	64
5.3.2.4.	Surgery	64
5.3.2.5.	Health Checks.....	64
5.4.	Food and Agriculture.....	65
5.4.1.	Nutrients.....	65
5.4.1.1.	Carbohydrate	66
5.4.1.2.	Amino Acid	66
5.4.1.3.	Fatty Acid.....	66
5.4.1.4.	Vitamins	66

5.4.1.5.	Minerals.....	66
5.5.	Entertainment and Sports.....	66
5.5.1.	Microgravity Exhibitions.....	66
5.5.1.1.	Microgravity Art Gallery.....	66
5.5.1.2.	Microgravity Museum.....	68
5.5.2.	Microgravity Performances.....	69
5.5.2.1.	Execution of Bodily Movement.....	69
5.5.2.2.	Appliance of Theatrical Components.....	69
5.5.2.3.	The Microgravity Viewing Experience.....	69
5.5.3.	Microgravity, Low-g Sports.....	69
5.5.3.1.	Quidditch.....	70
5.5.3.2.	Other Microgravity Sports.....	73
5.6.	Life Support.....	74
5.6.1.	Atmosphere.....	74
5.6.2.	Water Management.....	74
5.6.3.	Thermal Environment.....	74
5.6.3.1.	Thermal Comfort.....	74
5.6.3.2.	Temperature.....	76
5.6.3.3.	Humidity.....	76
5.7.	Contingency Plans.....	77
5.7.1.	Space Debris.....	77
5.7.2.	General.....	77
5.7.3.	Fire.....	77
5.7.4.	Air Leak.....	77
5.7.5.	Emergency evacuation.....	77
5.7.6.	Blackout.....	78
6.	Economy and Industry.....	79
6.1.	Tourism.....	79
6.1.1.	Divinity Walk.....	79
6.2.	Extraterrestrial Materials Processing.....	79
6.3.	Spacecraft Fabrication.....	79
6.4.	Perfect Crystals.....	80
6.5.	Sports.....	81

7. Conclusion.....	83
8. References	85

List of Figures

Figure 1. Radiation measurements taken on the ISS which orbits the Earth at 400km altitude. Note the high radiation above and around South America. The region depicts the South Atlantic Anomaly, an area where the Earth's inner Van Allen radiation belt dips down to 200km altitude, resulting in the increased radiation flux shown in the map. An orbit that does not go around the equator consequently must pass the South Atlantic Anomaly at some point, requiring radiation shielding far heavier than would be needed in an ELEO. Image credit NASA. [3] 14

Figure 2. Cross-section diagram of the Divinity space settlement and models of contemporary spacecraft and launch vehicle. Dimensions are shown in meters; the debris shield is omitted from this figure. 18

Figure 3. Simulation of tensile stress applied to the model 22

Figure 4. Prototype model of the combined cross-section..... 22

Figure 5. Hybrid torus cross-section. 23

Figure 6. Effective radiation dose rate on cosmonauts relative to the wall thickness of a Soyuz aircraft. The Soyuz was traveling from Earth to ISS and back, with the cosmonaut wearing Sokol space suit (inner thickness 0.5cm, outer thickness 0.1cm.) Thickness of the wall in centimeters: 0.5, 1, 2, 3, 4, 5, 7, 10, 15, 20. [36]..... 24

Figure 7. Effective radiation dose rate of an astronaut on the ISS' Zveda module with the wall thickness varying for each data point. Stay duration was 8 days with the astronaut in general clothing (thickness 0.1cm.) Thickness of the wall in centimeters: 0.5, 1, 2, 3, 4, 5, 10, 20. [36] 25

Figure 8. Schematic of the window layers installed on Divinity 27

Figure 9. The external schematic of the docking plates..... 29

Figure 10. The two-stage process of a spacecraft's docking to the settlement..... 30

Figure 11. Distribution of parking and docking blocks on the docking port. 30

Figure 12. 3D schematic of the operation of the gear docking system 31

Figure 13. Shape of the gear-shape docking plate 31

Figure 14. Operational scenario of the gears 32

Figure 15. Method of transporting docked spacecraft in a gear docking system..... 32

Figure 16. Configuration of the Active Protection Mechanism (APM) 34

Figure 17. Depiction of the cargo capsule with loaded payload 39

Figure 18. Side transparent view of the fully composed MTEV 39

Figure 19. 3rd person view of the MTEV from above with a single propulsion unit installed. The other two propulsion units are omitted to depict the underbody of the capsule mount..... 40

Figure 20. Velocity of the "basket" and payload to time of the space cannon. Velocity of the “basket” is shown in red while that of the projectile (payload) is shown in blue. 41

Figure 21. Velocity of the "basket" and payload to distance from reference point of the space cannon. Velocity of the "basket" is shown in red while that of the projectile (payload) is shown in blue.	41
Figure 22. Diagram showing the basic properties of a Retriever module. Note the 3-meter helical Kevlar bag	42
Figure 23. The Lagrangian Points of a two-mass celestial system [43]	45
Figure 24. Docking station system's administration software structure.....	58
Figure 25. Structure of the main administration system of the docking port.....	58
Figure 26. Structure of the emergency administration system of the docking port	58
Figure 27. Demographics according to age groups and their relevant percentage in the settlement population.....	60
Figure 28. An illustration of Skytram. Only one rail is shown with both the cargo and passengers shuttle	63
Figure 29. Documentation of Research Project Number 33: Investigating the Creative Process in a Microgravity Environment, 1988. Photo courtesy of the artist and NASA.	68
Figure 30. Astronauts on the ISS dissolved an effervescent tablet in a floating ball of water, dyed with food coloring. Photo credit: NASA Johnson Space Center [33]	68
Figure 31. Quidditch as seen in the movie series of Harry Potter. Daniel Radcliffe as Harry Potter is sitting on his broomstick at a Quidditch match, with the Hogwarts Quidditch field at the background. The Golden Snitch can be seen on the top right corner. Photo credit: Warner Bros.	70
Figure 32. Starting of the game at the US Quidditch World Cup 8, April 11, 2015, Manchester Meadows, South Carolina. Photo by Michael E Mason Photography, US Quidditch Press Kit October 2015 [35].	71
Figure 33. Sports Quarter of the Microgravity Complex. The main Quidditch stadium, practice Quidditch stadium, and sports reserve space are shown. A tunnel is used to get to the main Quidditch stadium from the central hub.....	72
Figure 34. Area distribution of the Sports Quarter as seen from above.....	73
Figure 35. A psychometric chart representing the acceptable combination of air temperature and humidity values according to the ASHRAE 55-2010 standard. The zone colored in blue represents 90% acceptability, or conditions between -0.5 and +0.5 PMV. [41]	76
Figure 36. A close-up view of atoms in a germanium crystal [31].....	81

List of Tables

- Table 1. Stages and process of agriculture on Divinity. The first column denotes the steps, where the end of the last step goes back to the first; the second column denotes the installation inside which the steps are conducted; and the third column describes the process of that step. .. 54
- Table 2. Properties of nutrients consumed by residents on Divinity. Type, consumption per day per person, consumption per year, and source for nutrients are noted. 65

Abbreviations and Terminology

APM – Active Protection Mechanism

atm – Atmosphere, a unit of pressure equivalent to 101,325 pascals

CNT – Carbon Nano Tubes

ELEO – Equatorial Low Earth Orbit

ESEI – Earth Space Elevator Infrastructure

EVA – Extravehicular Activity

GTO – Geostationary Transfer Orbit, a Hohmann transfer orbit used to reach geosynchronous or geostationary orbit

HEO – High Earth Orbit

ICM – Integrated Capsule Mount

ISS – International Space Station

kcal – kilocalorie, a unit of energy stored inside food. One kilocalorie is equal to 1,000 calories

kJ – kilojoules, a unit of energy

kV – kilovolts

LED – Light Emitting Diode, a light source principally constructed from two-lead semiconductors

LMD – Lunar Mass Driver

LSEI – Lunar Space Elevator Infrastructure

LTV – Lunar Transfer Vehicle

MDBP – Manifold Docking/Berthing Port

METV – Massive Earth Transfer Vehicle system

mGy – milligray, 10^{-3} gray, a measure of radiation

MPCV – Multi-Purpose Crew Vehicle

mSv – millisievert, 10^{-3} sievert, a measure of the absorption of radiation by the human body

NEO – Near-Earth Objects

OV – Orbiter Vehicle, NASA's designation for an operational space shuttle orbiter

PMV – Predicted Mean Vote model, the most recognized thermal comfort model which uses principles of heat balance and experimental data collected in a controlled climate chamber under steady state conditions

PU – Propulsion Unit

RCS – Reaction Control System

SLS – Space Launch System, a family of American Space-Shuttle-derived heavy expendable launch vehicles

STS – the Space Transportation System, the official designation of the Space Shuttle Program by the U.S.

TMA – Transport, Modified, Anthropometric, the Russian designation for the Soyuz spacecraft missions

TNT – Trinitrotoluene, a chemical formula most well-known for its explosive properties

VCM – Versatile Capsule Module

1. Introduction

1.1. Executive Summary

Project Divinity is about a space settlement for 10,000 individuals situated in the Equatorial Low Earth Orbit (ELEO), 500 km altitude above the equator. It is built in the near future where space tourism, coupled with commercial development of launch vehicles, provided enough incentives for primitive forms of space industry to grow. Project Divinity describes how the Divinity space settlement and its neighboring facilities can become the foundation for a new market for outer space.

The Divinity space settlement is a relatively small settlement approximately 400 meters in diameter rotating at approximately 2.114 revolutions per minute. Residence is provided in a hybrid torus whose “ground level” is 200m radially apart from the rotation axis. The torus is 65 meters wide, 45 meters “above ground” and 11 meters “below ground.”

The non-rotating part of settlement Divinity is composed of: The Industrial Complex, the Microgravity Complex, the Assembly Bay, and the Docking Port. The axis of rotation is radial to the Earth’s center, with each complex distributed “vertically”, i.e. from starward to Earthward. Connecting all the above modules, following the rotation axis, is a 15m-radius shaft named the Central Hub. The Central Hub is an unpressurized elevator shaft through which people, cargo, energy, and other life-support resources are distributed.

The Industrial Complex sits on the top (most Starward, or radially away from Earth) of the non-rotating part, and is a 70m-radius, 25m-high cylinder. The Industrial Complex can be divided into compartments that can be individually pressurized. The “ceiling” of the Complex is composed of retractable tiles which enable deployment of spacecraft or larger structures directly from the Industrial Complex.

The Microgravity Complex is divided into three sectors. Sector I is cylindrical with maximum radius of 100m and height of 33 meters. Sector I houses the transportation center between non-rotating and rotating parts, low-gravity gym, Starward hotel, and most importantly, the agricultural and oxygen-producing modules. Sector II is also cylindrical with maximum radius 100m but with a height of 40m. Sector II is further divided into the Sports Quarter, two Culture Quarters, and the Tourism Quarter. The Sports Quarter house two Quidditch stadiums and a Sports Reserve Space, the Culture Quarters house the microgravity art galleries, museums, theatres, performance halls, and practice room for the artists. The Tourism Quarter house the largest microgravity hotel in the solar system.

Sector III house factories and research institutions in a truncated cone of upper radius-60m, lower radius 50m, and height 20m. Industrial operations of extraterrestrial materials processing, and perfect crystal manufacture provide material profit while the material and biology research laboratories generate intellectual revenue.

The Assembly Yard is a cylinder 15m in radius and 25m high which connects directly to the Central Hub. Panel walls open up to intake cargo directly into the Central Hub. Control Deck above the Assembly Yard controls operation of spacecraft maintenance and operates the robotic rms. Airlock below provide for field worker’s EVA.

The Docking Port is a hemisphere 30m in radius where a rail mechanism is used to move spacecraft to parking places once they've been docked at the bottom of the Port. Inside the Docking Port is the Thorium nuclear reactor which supplies energy to the entire settlement.

To facilitate for the close intimacy Divinity has with Earth, project Divinity also describes new technologies of space travel. A new launch vehicle, Massive Earth Transfer Vehicle, is formulated, as well a space cannon for rapid transfer of cargo. As project Divinity relies heavily on lunar resources, a lunar base and a lunar mass driver is also conceived.

The economy of Divinity, other than tourism, industry, and research, is composed of revenue from sports and art, to which much resources of Divinity is invested.

1.2. Background

Project Divinity takes into much account recent findings by Al Globus [1] [2] [3] of a new paradigm of space settlements that are smaller, nearer, and consequently, more realistic. Many of the resources and systems used are taken on present-level technology or technology expected to arrive within the next century.

1.2.1. Location

1.2.1.1. Orbit

The Divinity space settlement is situated in the Equatorial Low Earth Orbit. The decision comes after the recommendation by Al Globus [2] for its accessibility and benefits of radiation shielding.

Divinity is situated on the equatorial orbit approximately 500 km in altitude, where it orbits the Earth once every 13.8 days at the speed of 6.92 km per second. The calculation can be done using the Orbital Velocity Formula, which is copied below:

$$v_{orbit} = \sqrt{\frac{GM}{r}}$$

Where, G is the universal gravitational constant ($G = 6.673E-11 \text{ N}\cdot\text{m}^2/\text{kg}^2$), M the mass of the body at center (mass of Earth for our purpose, $M = 5.98E24 \text{ kg}$), and r the radius of orbit in meters [4]. This formula gives the minimum speed the settlement should orbit the Earth. The actual orbiting speed should be marginally faster to take into account air drag, and should be sustained by occasional boosts via propulsion systems.

1.2.1.2. Radiation Protection

The 500 km altitude orbit is within the protection of the Earth's magnetic belt which deflects much of the solar and cosmic rays away from its interior. This conclusion is significant in that the radiation levels outside the Van Allen belts are so high that it requires immense amounts of radiation shielding materials to cover the exterior of the settlement, contributing to the difficulty of constructing a space settlement. Prior efforts to build space settlements, especially those done by students, either gave little thoughts for it or justified by referencing the abundance of resources available in outer space. While the former is blatantly myopic, much of the latter efforts still underestimate the astronomical efforts required to displace such amount of mass. This is especially concerning seeing how radiation shielding alone can constitute up to the later-90 percent of the entire settlement mass. [2] Also, as a sizable

portion of the settlement is in rotation, the mechanism of keeping such mass in rotation, or inquiry into whether the chosen shielding material has the composite characteristics necessary to keep its rotation status, needs much study, something that has been poorly investigated into. In most cases the rotating part is held taut from the center, meaning that the structure between the shielding mass to be situated on the outermost part and the inner lining should have the structural integrity capable of surviving such tension. In many cases these studies are neglected, even though failure to finding a solution means the entire rotating part has to be redesigned. Some designs like the Stanford Torus [5] has a separate, non-rotating radiation shield outside the rotation part that solves the structural integrity problem, but these designs must still answer the questions of transporting the shielding mass. Yet other designs [6] propose their own magnetic shields like that of Earth, but does not present a compelling method in maintaining the amount of magnetic shielding required, or sourcing the amount of energy to keep the shield. Of more concern is that many such proposals do not comprehensively investigate the influence of such strong magnetic fields on the human biology, or take into account how it will affect spacecraft passing through the magnetic shield. Seeing how much of our extraterrestrial lives will depend on digital instruments and the uncalculated for danger for communications malfunction, we have concluded that such solutions are ill advised.

In such backgrounds, a 500 km orbit requires no new method of shielding and utilizes a source that has been dependable for the past millennia, and whose property has been extensively researched for the

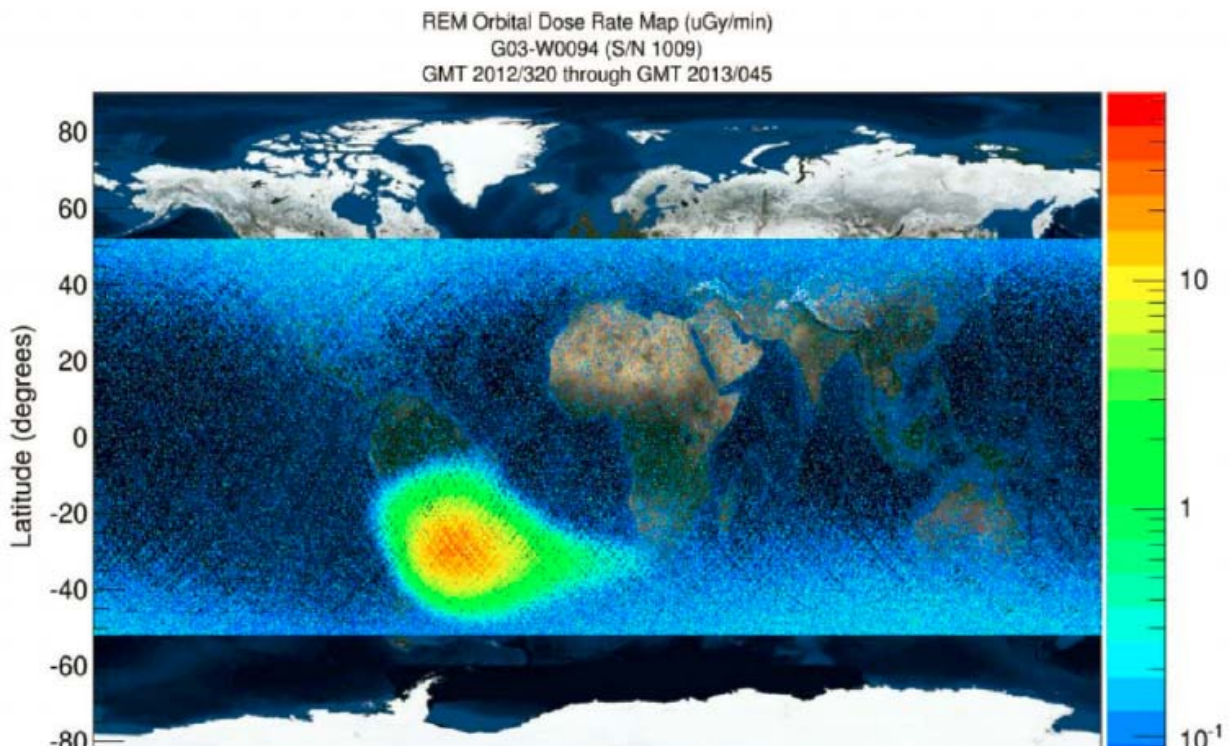

Figure 1. Radiation measurements taken on the ISS which orbits the Earth at 400km altitude. Note the high radiation above and around South America. The region depicts the South Atlantic Anomaly, an area where the Earth's inner Van Allen radiation belt dips down to 200km altitude, resulting in the increased radiation flux shown in the map. An orbit that does not go around the equator consequently must pass the South Atlantic Anomaly at some point, requiring radiation shielding far heavier than would be needed in an ELEO. Image credit NASA. [3]

past decades. Al Globus has done extensive research on the radiation levels at the said orbit using highly sophisticated NASA radiation modelling software OLTARIS, and concluded that the 500 km orbit requires not much more shielding than what would be generated by basic hull mass. In a crude summary, hull mass of approximately one ton per square meter results in interior radiation level below 20 mSv¹/year and 6.6 mGy²/year, which is seen, in the said study, to be acceptable levels of radiation even when considering pregnancy.

1.2.2. Time

In Appendix A: Settlement Growth Path of [2] a possible future of space exploration is outlined. In the paper, a symbiotic relationship between space exploration technology and space tourism is described, a relationship which will most likely set the stage for an exponential development of space. Project Divinity takes advantage of that possibility, setting the settlement Divinity in an imaginary, yet highly possible, prospect of a future where the space exploration boom has happened. Consequently, the next section will outline various components that the authors of this report believe to be developed within the next century.

1.2.3. Background

A large, High Earth Orbit (HEO) settlement requires literally astronomical amount of mass, which can be supplied only after sizable colonies have been constructed on the moon and among the Asteroids. Such background will require at least a century of preparation, a timeline too far away that, while prospectively fascinating, is of less merit to the authors herein who wish to research about a settlement realizable within the next century.

Based on the works by Al Globus, et al. the authors of project Divinity decided to place Divinity on a unique timeline. Assuming the space tourism industry to bloom within the next few decades, certain advancements in both orbital transportation technologies and extraterrestrial industry will come by. Project Divinity will delineate these factors in its own account, specifying and extrapolating to the extent where it may be deemed feasible for the next century.

1.2.3.1. Propulsion Technologies

For propulsion technologies, Divinity will assume the development of reusable rockets that will fly as frequently as a hundred times per year. A global fleet of such rockets numbering up to hundreds will enable flight rates of tens of thousands, if not more. And with each operating country or company providing different types of payload at different safety level, cost, and time, the space launch market will see a significant reduction in flight prices. With NASA's Orion Multi-Purpose Crew Vehicle (Orion MPCV) having a crew of 2-6 astronauts [7] and Space X's Dragon spacecraft having a crew of 7 people [8] at concurrent times (year 2016), it is reasonable to expect that the space vehicles to be developed in the next decades to have crew capacity in the double digits. For the timeline of Divinity, spacecraft of 15 crew seems feasible, and even 20 not entirely unrealistic. With over a hundred launch vehicles operating as frequently as hundred times a year, ticket prices for passengers to go out into orbit, or the price of settlers to ELEO space settlements, drastically decrease. Specifically, assuming a

¹ mSv – millisievert, 10⁻³ sievert, a measure of the absorption of radiation by the human body

² mGy – milligray, 10⁻³ gray, a measure of radiation

total of twenty thousand manned launches per year with each launch carrying 20 passengers to LEO, the cost per passenger would be little over 160,000 U.S. dollars in 2015 rates. [9] [10]

1.2.3.2. Resource Development

For resources, Divinity will assume primitive resource market on the moon and asteroids. While the cheapest way of delivering high-quality cargo to orbit currently envisaged is the Earth Space Elevator Infrastructure (ESEI), the fact that it would extend well over the geostationary orbit altitude of 35,800 km at the equatorial orbit makes its presence incompatible to a settlement at 500km ELEO. As such, the next cheapest way of delivering materials will be from the moon or Asteroids, excluding rocket delivery methods. While an advanced lunar base comparable to small cities may not come around within the next half century, some form of resource launch facility will almost certainly be in place. For USA, NASA has been steadily taking steps to re-visit the moon, with the new Space Launch System (SLS) and Delta IV Heavy rockets being able to deliver spacecraft such as Orion MPCV to go to the moon and beyond. The X Prize Foundation has kept a continued interest to visiting the moon, with the google Lunar X PRIZE reinvigorating public's interest since 2007 [11]. For China, the China National Space Administration (CNSA) has launched the Chinese Lunar Exploration Program (CLEP), with its ultimate goal being the exploitation of lunar resources of titanium and helium-3 [12]. While other countries such as Russia, India, Japan, and South Korea has expressed interest in building a resource base on the moon, whether they will achieve this feat within the next half century and maintain the capacity to operate it to a sizable degree is to be seen. But even so, the amount of interest in the United States and China alone is already quite sufficient to expect a lunar resource base within the next half century. For this, Divinity assumes some wealth of resources to be easily transported from the moon, which will prove especially valuable when creating the base structures for the space settlement that will require no higher physical properties than compacted lunar regolith. Specific size and capacity of the lunar bases to mine and ship lunar resources will be further explained in later chapters.

While the moon is the largest resource depot on Earth orbit, Asteroids represent a more versatile source of resources, especially in ice and heavy metals. For this, at least two U.S. private companies, Planetary Resources and Deep Space Industries, have taken a leading role in harnessing Near-Earth Objects for commercial value. With Planetary Resources planning to have the capacity to deliver water from asteroids as early as the early 2020s [13], and Deep Space Industries to send out its first fleet of probes in the 2010s [14], resources, and even elementary products made from Deep Space Industries' prospected 3D printing labs, will be acquirable at the stage of Divinity's construction.

1.3. Acknowledgements

Many members of team Divinity are now going through their second year of participating in the NSS-NASA Ames Space Settlement Contest. The members have learned a lot from the two years, the 2015 International Space Development Conference, the feedback we had from our friends and peers. Team Divinity also participated in the 2015 Asian Regional Space Settlement Design Contest as a non-Indian semifinalist, where we could see the contrast the two international competition for space settlement design. For this, we would like to thank Mr. Al Globus for giving us this unique opportunity to truly "research" and scientifically indulge in the science of space settlements.

While we could have recycled the proposal we gave for the 2015 ARSSDC, we saw how different the two competitions were, and the value NSS-NASA Ames Space Settlement Contest had over the other

in terms of original, yet realistic study into the mechanics of space settlements. As to this, we decided to construct a wholly new design based on Mr. Al Globus' most recent works, taking into account the various papers he wrote for the topic. While our report may lack in quantity from our last year's submission we hope that we have given a more thorough and comprehensive view into the true mechanics and architectural virtue of the settlement.

Last of all we would like to thank KangSan Kim (a.k.a. Antonio Fowl Stark), our good friend, leader, and now our advisor. He has led the team for last year's competition and for this year's ARSSDC, and was the prime motivator for us to construct a new design for this year's NSS-NASA Ames SSDC. His motivation and enthusiasm was many times what kept us going forward.

2. Structural Design

2.1. Structural Overview

Divinity space settlement is comprised of rotating and non-rotating sections. The rotating parts are the residential torus and the connecting spoke while the non-rotating sections are the central hub, industrial complex, microgravity complex, assembly yard, docking port, and debris shield.

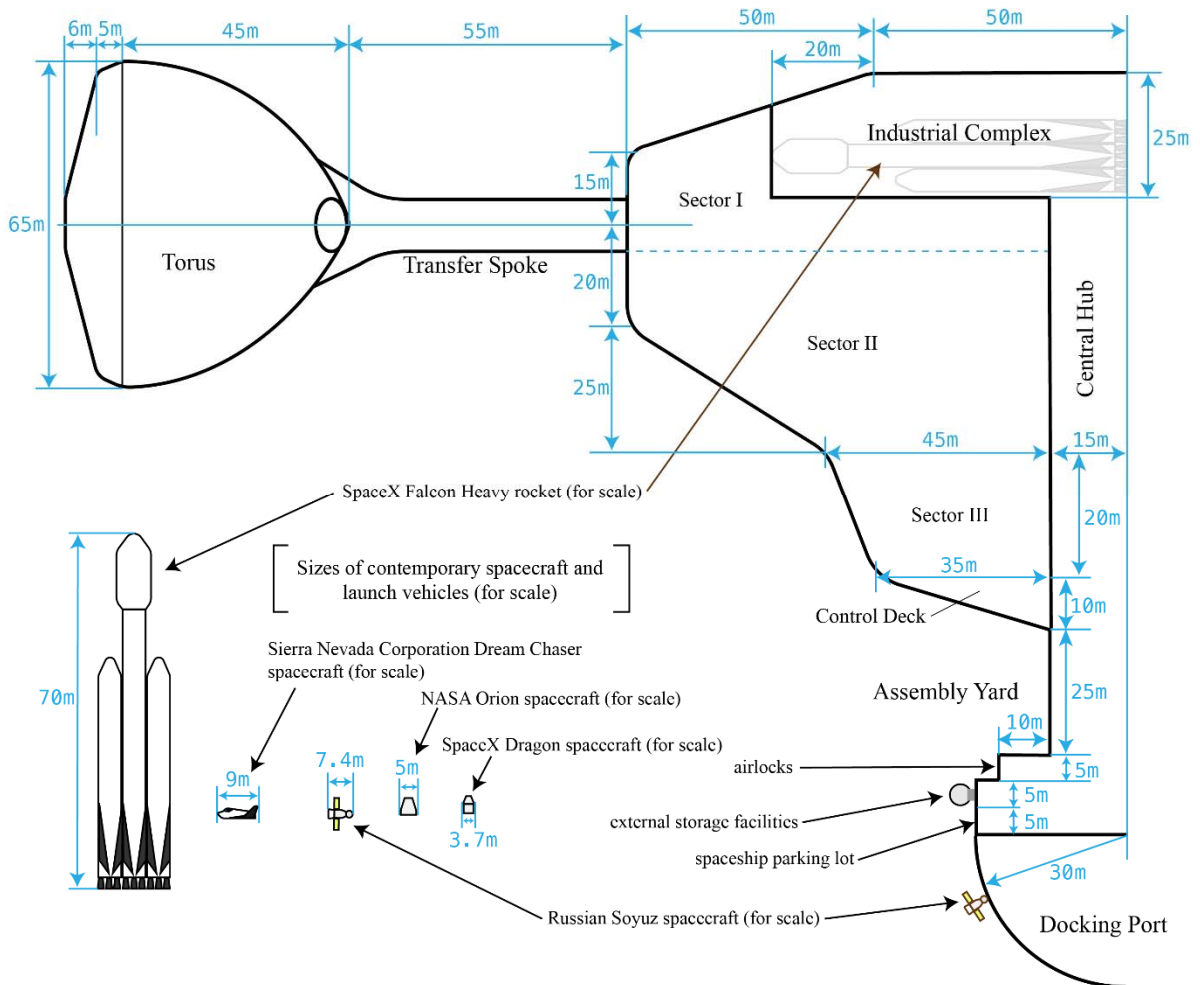

Figure 2. Cross-section diagram of the Divinity space settlement and models of contemporary spacecraft and launch vehicle. Dimensions are shown in meters; the debris shield is omitted from this figure.

The torus extends radially away from the centerline at a distance 155 to 211 meters. The “ground” of the torus, which is set to be the ground level for our purposes, is at 200 meters from the centerline, with 45 meters “above ground” and 11 meters “below ground.” The torus is 65 meters wide at the ground level, with the width tapering down in a somewhat logarithmic manner above ground, and in a more precipitating shape below ground. The “above ground” section of the torus is almost entirely used for residential purposes while the space “below ground” is used for treatment facilities, storage, and common areas that does not necessarily have to be above ground and takes up much space. The

below ground section is further divided into accessible areas and inaccessible areas. The accessible area is from 0 to 5 meters below ground, and is a mere extension of the residential community where facilities such as hospitals, shopping malls, and service departments are located. Population traffic into the accessible area is high. The inaccessible area houses water treatment facilities, air purification plants, waste management plants, emergency resource storage facilities, and computers that manage the internal torus network. The inaccessible area is almost entirely unmanned, and is accessible only by authorized personnel due to its importance, and is designated ‘inaccessible’ to the general population.

The transfer spoke is a square pillar of radial length 55 meters and side length 10 meters. A total of 6 transfer spokes, the spokes manage transportation between the non-rotating and rotating sections of the Divinity settlement. Each spoke has 12 compartments, 6 of which is from the non-rotating sector to the rotating sector, and the other 6 going the other way. The spoke is symmetrical to the center plane orthogonal to the central axis so as to provide redundancy and safety when one or more traffic line is jammed. In total a transfer spoke has two passenger transfer tunnels going outwards, two passenger tunnels going inwards, two cargo tunnels going outwards, two cargo tunnels going inwards, and two resource pipes going outwards and two resource pipes going inwards.

The non-rotating part consists of 6 parts: the central hub, the industrial complex, the microgravity complex, the assembly yard, the docking port, and the debris shield. In total, the non-rotating part extends 100 meters radially and stretches 175 meters from top to bottom. The “top” direction of the settlement is radially outwards from Earth, or “starward” as the authors of this paper like to describe. The “bottom” direction points down to Earth, with the terrestrial resources right at hand.

The central hub is a shaft of radius 15 meters that connects the entire non-rotating parts. It is hollow with rails on its sides that allow for pods and robotic arms to travel up/down and sideways.

The industrial complex sits at the top, or starward direction of the non-rotating structure. It is 70 meter in radius from the centerline, 25 meters in height. The industrial complex is compartmentalized into various sectors whose size can be varied when needed. The industrial complex has direct access to the central hub, so as to transfer resources directly from the assembly yard. The industrial complex has a tile ceiling, which can be opened or closed selectively. This allows some sectors to operate in a pressurized environment while others sectors can be depressurized to utilize the unique space environment. Many larger spacecraft and settlement parts are manufactured on the Divinity industrial complex, which can be directly deployed into outer space right after its completion. Although the industrial complex is large enough (over 330,000 cubic meters of volume³) to accommodate for

³ The volume of the industrial complex can be computed by adding the volume of the cylindrical part and the truncated circular cone part. The former is a cylinder of radius 70 meters and height 18 meters, the latter a truncated cone of upper radius $r_1 = 50\text{m}$, lower radius $r_2 = 70\text{m}$, and height $h=7\text{m}$. The formula for the volume of a truncated circular cone is: $\frac{1}{3}\pi(r_1^2 + r_1r_2 + r_2^2)h$. Using this formula and the values above, the total volume of the industrial complex is approximately 331333.3051986 cubic meters.

multiple Falcon heavy rockets⁴ (see Figure 2) and even the entire international space station⁵, the ceiling can be fully opened to work on larger structures.

The microgravity complex can be further divided into three sectors. Sector 1 is 28 meters in height and 100 meters in radius, and shares its height with the industrial complex. Sector 2, the largest of the three sectors, also has radius 100 meters at the top which tapers down to 60 meters from 15 meters from the top level. Sector 2 is 40 meters in height and consecutively houses the larger facilities and institutions. Sector 3 tapers further from radius 60 meters to 50 meters for 20 meters' height, and then combines completely with the central hub (radius 15 meters) for the next 10 meters.

The assembly yard 30 meters in height of which the upper 25 meters is same with the central hub at radius 15 meters. The entire cylinder of height 25 meters is made of small tiles hinged against each other. As such, the wall can open as much as needed, allowing input of any resources delivered from Earth as long as it is smaller than 25 meters high and 30 meters in radius, or can be rotated to an orientation that can fit into such space. The last 5 meters of height extends 10 meters further from the central hub, and houses the machinery and airlocks for operation at the assembly yard.

The docking port is composed of three parts: the 30 meters' radius, 5 meters' high cylindrical storage facility, 30 meters' radius, 5 meters' high spaceship parking lot and maintenance facility, and the 30-meter radius hemispherical docking ports. The cylindrical storage facility also has external riggings to store fuel for rockets or cargo for temporary stay. The ledge created by the 5-meter radius difference between the lower end of the assembly yard and the upper end of the docking port also serves as rigging for astronauts on EVA to hold on to, as well as structures upon which trusses can be built for spaceship maintenance. The docking port work in tiles so that spaceships attached from the lowermost end of the hemisphere can be moved to other parts of the sphere for temporary storage. Longer-term parking spacecraft or spacecraft reserved for emergencies are moved to the spaceship parking lot.

2.2. The Torus

The torus is a cradle for the residents staying at Divinity. Except for the few temporary visitors and the workers at the industrial complex section of the settlement, the majority of the residents live their daily life inside the torus, working during the day and sleep at night. The wall of a residential torus is the only protection against the extreme environment of the Space for humans. Under hard vacuum and a severe thermal condition fluctuating from minus 120°C to 120°C, no human can survive. Water inside human body would boil up, and the body would start to freeze from the inner surface of mouth and nose where the evaporated water come out through. Atop of all that, lack of oxygen would cause respiratory and circulatory system to fail, eventually leading to death within a few minute. Even with a proper protection device such as spacesuits, one cannot survive in Space for more than few days as life support system would not possibly last very long.

Hard vacuum and temperature fluctuation is a small proportion of a danger that Space poses. Unlike living on Earth where a thick layer of atmosphere shields most of the exterior threat, there's always a danger of cosmic radiations when living in Space. Continuous exposure to cosmic rays would cause

⁴ A Falcon Heavy rocket manufactured by SpaceX has a height of 70m and width of 11m. The Falcon Heavy has a diameter of 3.66m [43] with two additional strap-on boosters also of diameter 3.66m [42].

⁵ The International Space Station is of length 72.8m, width 108.5m and height 20m [44], and will fit comfortably inside the diameter 140m, height 25m cylindrical industrial complex.

severe damage to the body, and even a sunlight that we encounter in our daily lives can be lethal to the residents in Divinity if there are no proper protections against it. Orbital wastes and asteroids are also a deadly threat to the settlement, and the torus should be capable of guarding the settlement from all these threats. Thus the exterior structure of the torus should be designed to endure both collision and cosmic radiation.

When designing the torus, there must be a lot of deliberation about designing the torus so as to achieve as much utilizable space as possible. The volume of the torus is clearly the key factor to increasing the population. A single living house is not the only space one need to live-that is, the requirement of space per capita increases as the population increases. If the population doubles, not only the residential area must be expanded, but also other subordinate systems of the settlement should also enlarge their labor amount. Agricultural industry would have to double the yield, water processing system would have to cope with larger waste water input and the atmosphere control would have to process twice as much carbon dioxide. Every single resident's life is deeply related to the entire flow of the settlement, and therefore acquiring enough space for such correlative systems is a priority. Simply enlarging the torus to increase the volume is not a wise solution to the problem, however. The design must be precisely deliberated and planned that the result construction meets all the need and is able to cope with future situations.

The shape of the settlement, regarding the volume to mass value as the prime factor, should be the sphere. However, as this is a space settlement that provides pseudo-gravity by rotating, spherical shape actually loses majority of its volume and also disadvantages from its widely gradient gravity. From this we come to tori and cylinders as the viable answer to the choice of the shape of the settlement.

Conventional tori system of space settlements has circular cross-section. The down-surface (the surface where the pseudo-gravity is vertically applied) of this type of torus is relatively parallel to the rotational axis, thus minimizing gradient gravity and it also has great volume per mass ratio. However, the circular cross-section actually comes across as inconvenience. Most prevalent industrial designs and our living appliances are designed to fit in a cubical space as it is much simpler to design. The circular cross-section makes construction or installation of the system complicated, and lots of spaces should be wasted. Devices with large dimension would consume irrelevantly massive volume that can be otherwise efficiently used for storage. However, designing a torus with a square or rectangular cross-section cannot be the resolution as it comes with several disadvantages as well.

To increase the overhead volume (above the 'down-surface') much larger input of construction material must be invested. Poor openness induces claustrophobic syndromes and other psychological disorders that might in overall discourage the society of the settlement. Therefore, acquiring adequate overhead volume is necessary to provide the perception of spaciousness. However, to expand the cross section surface of the rectangular torus the required construction material inevitably hikes, much greater compared to circular or triangular shape. Divinity's main torus has a radius of 200m. This means immense amount of resources and time must be spent for the construction, and every single design must be carefully deliberated to achieve maximum efficiency.

The outer rim of the torus functions as the action point that supports the entire structure from the centrifugal force and counteracts with centripetal force. That is, every mass body in the torus is applied with centripetal force during the rotation by the wall of the outer rim of the torus. Ergo the wall structure

of the torus must put up with high stress and tension from the load, unlike conventional space habitations that only need to provide pressurization and life support. At the same time, the inner rim of the torus must endure extreme tension between the spokes and the torus. In summary, two parameters are established as the criteria of an effective settlement torus design; efficiency of the interior volume configuration and tensile durability of the structure.

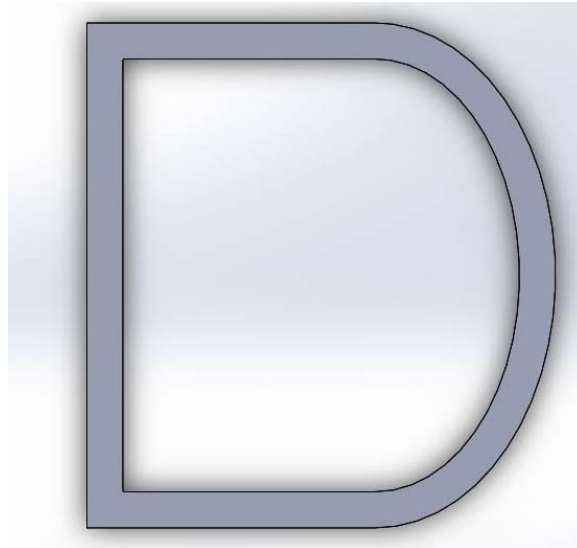

Figure 4. Prototype model of the combined cross-section.

In this perspective, clearly circular and rectangular shape is unsuitable and we initiated a research in pursuit of the optimal torus cross-section design. Although the original shapes are excluded, we came to the conclusion that the benefit of respective designs is worth being employed. The conclusive cross-section design is an arch with a perpendicular ‘bottom’.

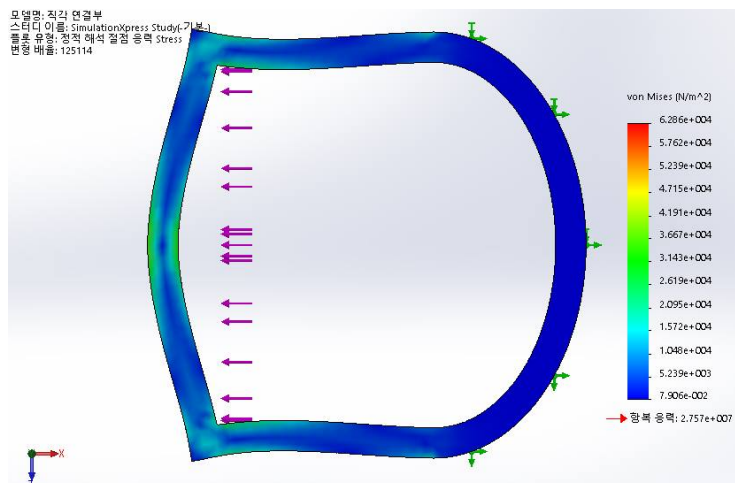

Figure 3. Simulation of tensile stress applied to the model

What’s shown as a purple arrow on Figure 3 is a force is applied to the torus structure by the mass bodies within the torus. It’s apparent that the middle section of the outer rim wall is heavily loaded, and it is anticipated to be resolved by simply placing a bracing pillar between the inner rim wall and

the outer rim wall. During the rotation, there is a danger of the deformation of the structure by the stress concentrated to the section where the spoke of the torus meets the inner rim of the torus. So we came up with another improvement to this design as shown on Figure 5.

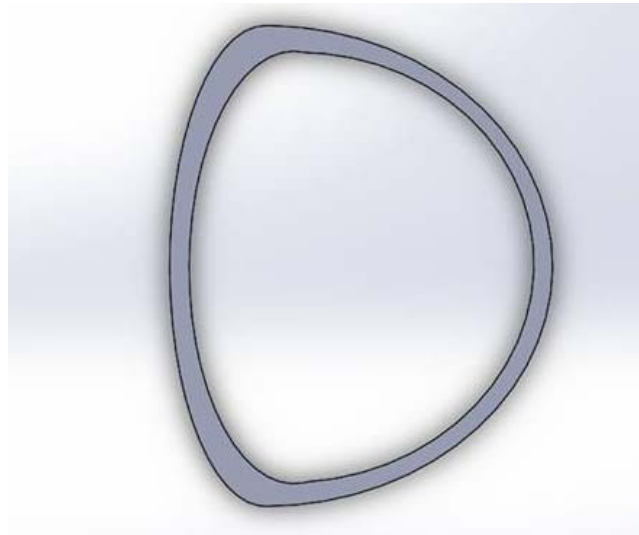

Figure 5. Hybrid torus cross-section.

Majorly the outer rim that was previously is modified to have more arc and curve in the overall shape, and is now reinforced with more tension-resilient materials. The curved inner surface is intended to fit living infrastructure (electricity, water supply) and agricultural system. Parallel floor configuration requires specific amount of volume allotted for these infrastructure which leads to inefficient volume designation.

Devising the services of the torus comes next to designing the structure. As abundantly explained, the torus is the only existing barrier between the residents and the extreme space environment and must be able to sustain essential life support system. There are three major elements that are subject to human habitation in space-temperature, atmosphere, and radiation. Direct exposure to the sunlight gradually raises the surface temperature of the object and the radiated energy provokes molecular motion. The outer barrier of the torus must be built with rigid metal alloy that can endure consistent sunlight exposure and temperature fluctuation. Transparent windows for sight-seeing also must be given with sunlight protection coating.

Pressurization is also an important matter, second to none. As the Earth, all residential areas of the settlement (let alone the torus) are kept with 1.0 atm⁶ of atmospheric pressure. This means that the entire construction must withstand great pressure disparity. Even a millimeter's diameter of a puncture on the torus would cause air leakage, which draws more pressure to the spot and eventually leads to macro hull breach that cannot be mitigated nor repaired. For ISS which is a relatively smaller figure compared to Divinity and a micro-gravity environment, trained personnel can initiate emergency EVA to perform repairing on the damaged structure while the module is locked up. On the other hand, Divinity is not like ISS in most ways-it has a 1G of pseudo gravity, a single pressurized section is at

⁶ Atmosphere (unit). A unit of pressure defined as 101,325 Pa (pascals), a value approximating the mean atmospheric pressure at mean sea level.

least tens of thousands of cubic meters large, and the residents are but civilians-some of which are infants and the elderly-who are assumingly not trained for EVA. A hull breach in Divinity is prone to become a disaster, and therefore the construction and maintenance of the torus must be followed by thorough inspections to insure the integrity.

For last but not least, there's a radiation protection issue. Cosmic rays emitted from celestial bodies all over the universe reach out every single surface of the object in space and Divinity is not an exception to this issue. Although Divinity is secure at ELEO under the protection of the magnetic field spread across the van Allen belt, still it must be insured that the settlement is equipped with sufficient basic radiation protection. Cosmic radiation damages agricultural industry by disrupting plant growth and causes malfunction of electric appliances, and also erodes the objects when directly transmitted to the surface.

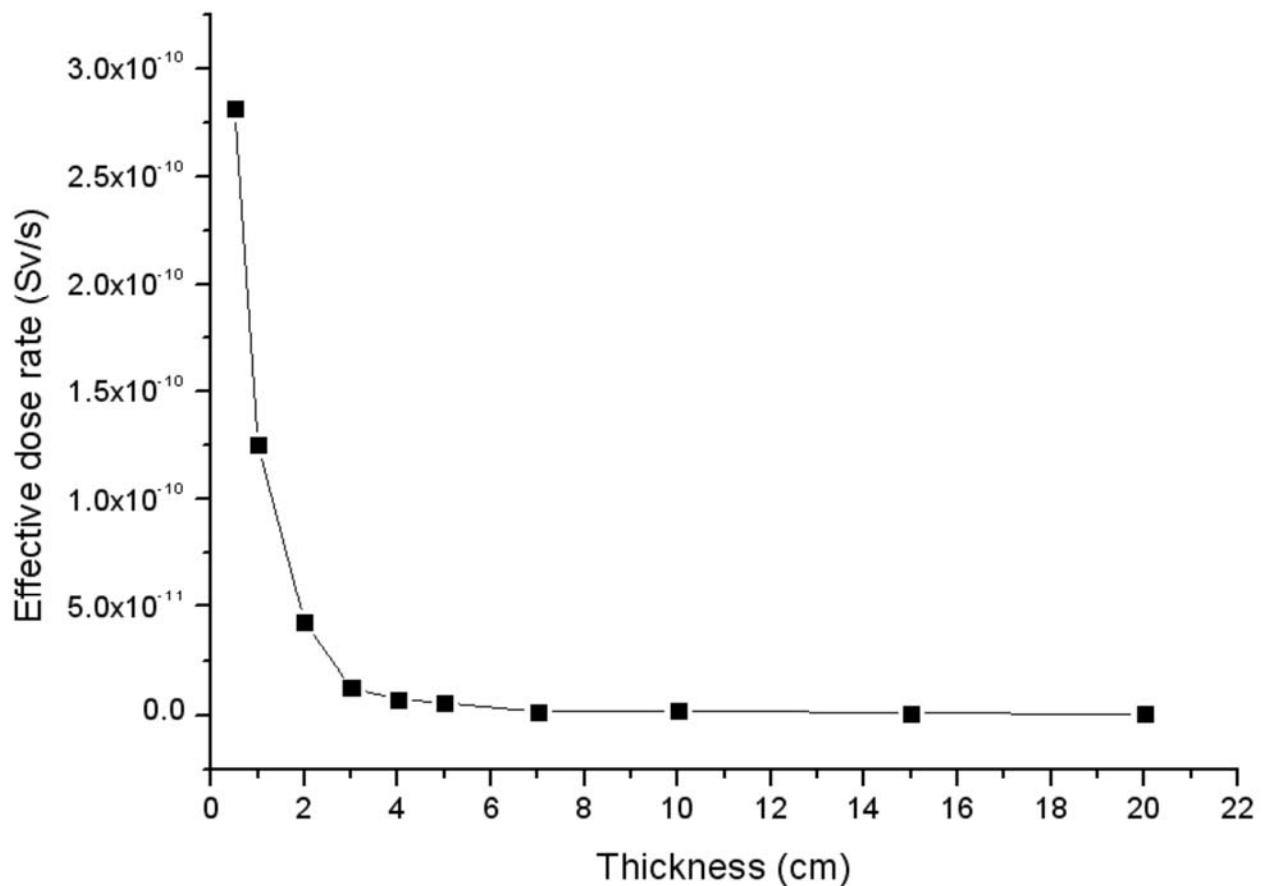

Figure 6. Effective radiation dose rate on cosmonauts relative to the wall thickness of a Soyuz aircraft. The Soyuz was traveling from Earth to ISS and back, with the cosmonaut wearing Sokol space suit (inner thickness 0.5cm, outer thickness 0.1cm.) Thickness of the wall in centimeters: 0.5, 1, 2, 3, 4, 5, 7, 10, 15, 20. [41]

The diagram depicts the effective dose applied to the astronaut inside the Soyuz orbital vehicle per the thickness of the wall. (composed of aluminum) It's visible that the effective dose decrease rate gets steady over the thickness of 4 centimeters.

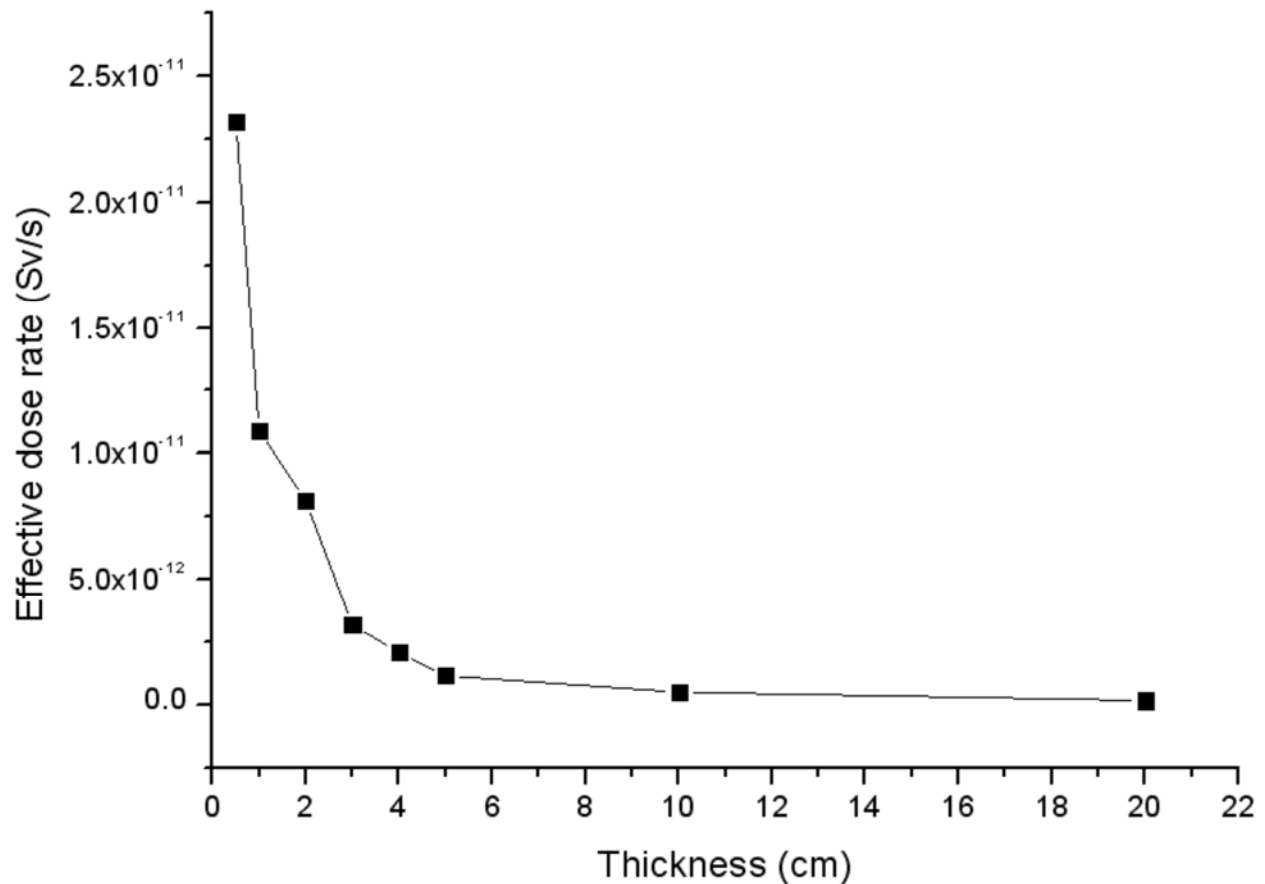

Figure 7. Effective radiation dose rate of an astronaut on the ISS' Zvezda module with the wall thickness varying for each data point. Stay duration was 8 days with the astronaut in general clothing (thickness 0.1cm.) Thickness of the wall in centimeters: 0.5, 1, 2, 3, 4, 5, 10, 20. [41]

Figure 7 depicts the effective dose applied to the astronaut inside the ISS Zvezda module per the thickness of the wall. This data is compared with that of Soyuz as both of them adopted a similar 95% Aluminum composite radiation shield. Each of them are subject to only Aluminum-based components, but as the existence of thin atmosphere and magnetic shield at the orbit would alleviate the need for thick structural protection.

2.3. Spokes

There are 6 total spokes in Divinity. Their function as the passageway for supplies and residents make them a fundamental structure of Divinity directly connected to the lives of residents. Spokes will be made with lunar regolith in titanium frame on the moon. The inside of spokes consists of tunnels for diverse functions such as the resident shuttle and the cargo shuttle. As for the resident shuttle, it will be operated with most consideration to avoiding confusion and providing comfort to residents. For example, rush hours will be supported with more cars. Also, considering the fact that big cargo shuttles will not be used frequently, energy costs can be saved considerably by lengthening the time between two shuttles. More information will be in part #4.1 spoke. Shuttle operation plan will be on appendix.

2.4. Central Hub

The central hub is the central cylinder of radius 15 meters and height 140 meters that connect all the modules, except for the torus, together. The central hub, is basically a hollow tunnel carved out in the middle of the settlement with openings at the assembly yard and the industrial complex. Elsewhere, there are gates and airlocks at respective floors at each sector. The inner surface of the central hub is lined with transportation rails, embedded wires that carry electricity from the generator at the docking port, and pipes that carry water and oxygen.

Pressurized passenger modules and unpressurized cargo modules and robotic arm carts travel along these rails. Rails are situated both horizontally and vertically, so that modules can change lanes or arrive at different sections of the same floor. People traveling via pressurized passenger modules need not get into EVA suits as airlocks between the central hub's wall and the passenger module do away with the need for individual depressurization and re-pressurization.

The central hub is kept unpressurized because of its frequent openings in the assembly bay and industrial complex, where maintaining a pressurized environment would be both impractical and economically unsound.

2.5. Industrial Complex

The industrial complex is a cylinder 70 meters in radius and 25 meters in height. It is situated at the top of the non-rotating portion of the Divinity settlement, with paneled ceilings that can open up when needed. Its walls and ceilings are a mix of lunar titanium and reinforced plastic, the former for the outermost shells that require no reactivity over other virtues, and the latter for temporary walls or compartment walls that require mobility more than no reactivity.

2.6. Microgravity Complex

The microgravity complex is the central cylindrical part of Divinity which consists of the Transport Center, the Sports & Culture Center, Research Center and assembly yard. It is the economic, cultural center of Divinity. It is divided into three sections, named sector 1, 2, 3 from the top and going down. Sector 1 and 2 allows the visitor to appreciate the outer space scenery by windows composing the outer wall.

2.6.1. Wall Materials

The materials used for the cylinder will be a concoction of compressed lunar regolith, titanium extracted from the moon, and aluminum from Earth. The main purpose of the wall, other than to provide structural support for everything within, is to protect residents from radiation. The wall will also help create an environment with livable temperatures. Since the percentage of radiation that manages to get through declines exponentially with wall thickness, the thickness will be controlled in thoughts of shielding the people (mainly workers) inside. However, unnecessarily thick walls will incur excessive charges, and a balance between radiation protection and economic feasibility is needed.

Having glass windows will provide a view outside of Divinity to residents and tourists. It can help prevent claustrophobia and serve as a major tourist attraction to those from Earth. However, the major problem with having windows completely made out of glass is that the commonly included elements of glass such as silicon, sodium and calcium are not capable of blocking radiation. Therefore, Divinity will make use of lead glass, which is glass with lead, a radiation shielding material, in the place of

calcium. The complete Divinity window will be a combination of 5 layers with 3 materials, with the outermost material being conventional glass, the second layer lead glass, the third layer a lattice of lead, the fourth layer lead glass, and the innermost layer conventional glass again. The lead in this structure will block radiation, and layers of conventional glass will protect humans from lead poisoning. Furthermore, each layer will be protected by security window films, which will protect other layers even if one layer is broken by impact. Only the broken layer will need replacement.

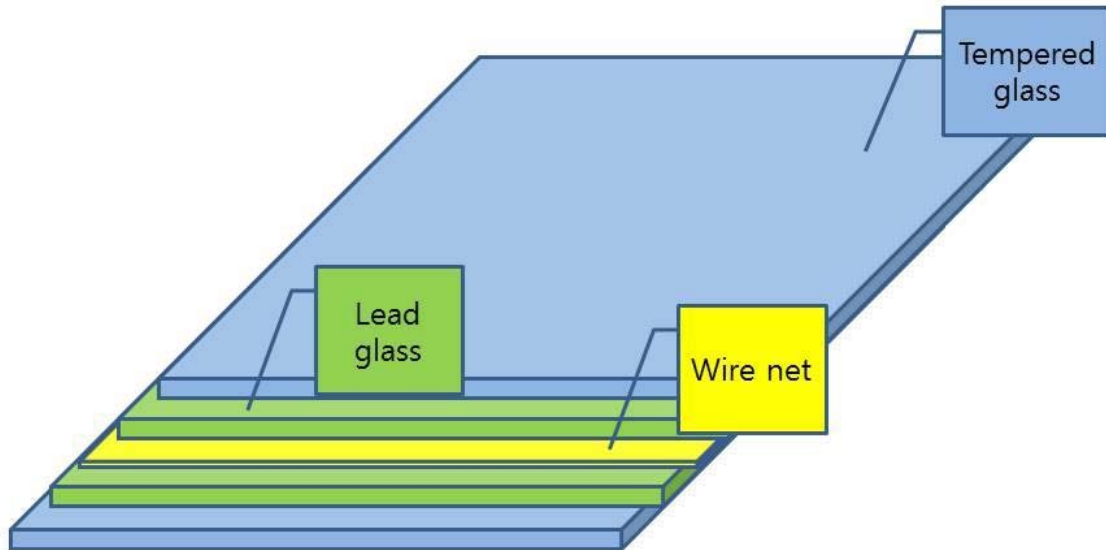

Figure 8. Schematic of the window layers installed on Divinity

The window will go all around the sectors like a belt, made up of triangle plates of Divinity glass to form a truss structure. Since the truss structure gives much less stress to its components than other structures like squares, they are frequently used in bridges and buildings of Earth. This is due to the fact that the triangle is a shape that resists being deformed. The structure is expected to function the same for the windows of Divinity.

2.6.2. Rotation Mechanism

2.7. Assembly Yard

The Assembly Yard is where articles from outside are unloaded to be repaired or undergo basic manufacturing. Its function can be compared to that of a seaport on Earth where shipment comes in or go out. A cylindrical structure 25 meters high and 15 meters in radius, the central hub section of the assembly yard enables incoming shipment to be directly transported via the central hub. The walls of this section are made of 95 tiles each 5 meters high and 5 meters wide stacked five stories high and 19 segments around.

Every segment is hinged against each other whereupon every hinge is detachable given commands by the central command center. These controls allow for the walls to open against each other, where the same tile can be used as a supporting wall in one instance, but the “door” in another. Theoretically only

one column of tiles is needed for the support of the structure, giving the maximum size of the door and corresponding opening space of 25 meters high and 90 meters around, but such a circumstances is in most cases not needed. For one, the maximum “gateway” is the height times diameter of the central hub, and openings of greater width than the half circumference of the hub does nothing to increase the gateway. Secondly, the hatch opens for either of the two purposes: a) to deliver an incoming shipment from Earth to the industrial complex or b) to deliver an outgoing shipment to Earth from the industrial complex or the various factories at sector III. For the former case, there currently is no propulsion technology that can deliver such a large payload to LEO, and there is no reason to fabricate and assemble large structures on the Assembly Yard and then transport it to the hanger in the Industrial Complex when the same job can be done with much efficiency at the Industrial Complex itself. For the latter case, the authors of Divinity cannot conceive any project that will require large structures of such size to be manufactured in microgravity and to be sent down to Earth.

The Assembly Yard has two more sections crucial to its operation. The control deck rises 10 meters above the main assembly yard space, and stretches outward another 35 meters at an inclination. This inclination is composed of glass, giving yard managers a wide view of their projects, the counter-emergency crew to spot any abnormal activity, and for the robot controllers to operate much more accurately. Below the yard is a balcony 5 meters high and 10 meters additionally outward which houses the airlocks and facility required for Extravehicular Activities (EVA) of field workers.

Multiple robotic arms are scattered around the perimeter of the assembly yard, which does heavy-duty jobs or move around railings that support field workers in EVA.

2.8. Docking Port

2.8.1. Docking Mechanism - Railway

The docking station, a major hub of the settlement's transportation infrastructure, is composed of Manifold Docking/Berthing Port (MDBP) on the exterior and the Central Platform amidst the surrounding MDBP structure. The MDBP is a spherical skeletal structure consisted of seven rotatable latitudinal rails (each of them named ‘line’s) and five longitudinal rail (each of them named ‘row’s). Of total twelve lines, the bottom four are Docking port and Undocking port and the upper five are designated as parking lines. The Central Platform is a hub where all the disembarked cargos and passengers are convened to proceed to the destination inside the settlement. Mobilized channels are equipped with electric power supply and versatile transfer system and connect each ports to the platform. Each vehicle that are done with the procedure are then hauled to the upper rows, away from the port thus clearing the perimeter. This organized infrastructure allows multiple rendezvous plans to be conducted simultaneous highly efficiently.

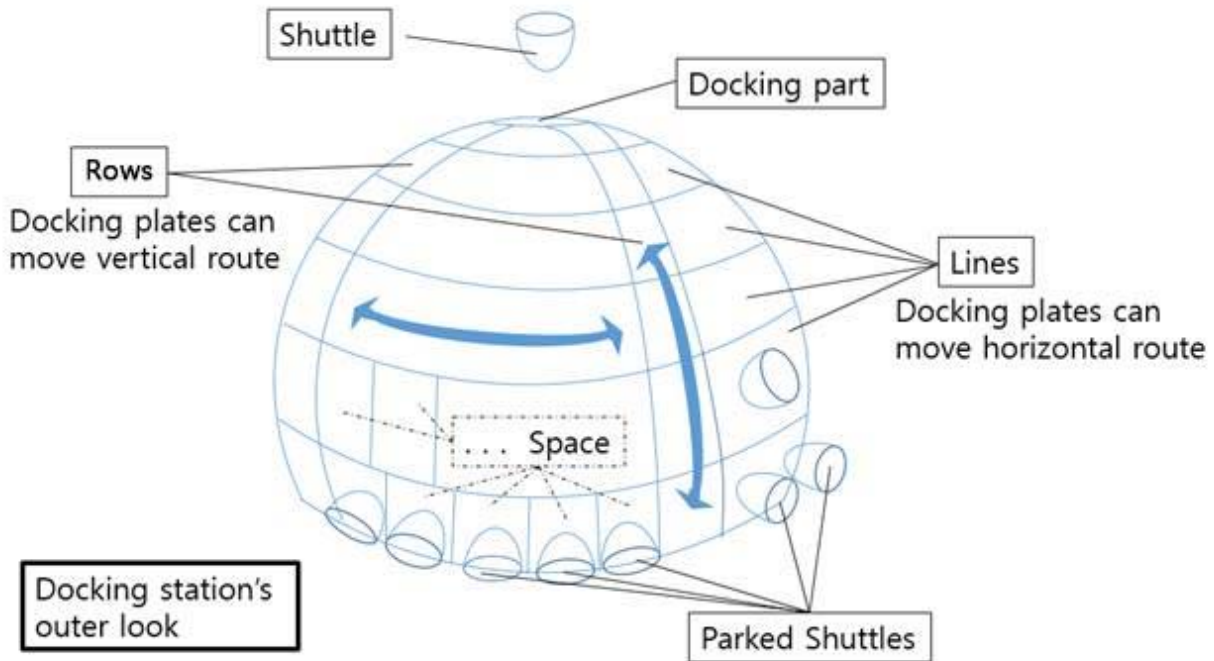

Figure 9. The external schematic of the docking plates

The docking/berthing of the spacecraft (henceforth shortened as “docking”) is a two-stage process. The primary stage is what’s commonly known as the ‘soft docking’, which is engaging a contact between the spacecraft and the docking plate at the port. This is only a mechanical coupling that secures the vehicle while it’s transported via the row rails to the parking line. The secondary stage is the ‘semi-hard docking’, where the channels reach out to the docking plate and make the mechanical connection. Whether or not the pressurization is carried out depends on each vehicle’s operational feature. Undocking procedure is the opposite of the docking procedure- all the payloads and crews embark/board the vehicle parked at the parking row, the docking plate dislocates from the parking line, and move to the undocking line to undock.

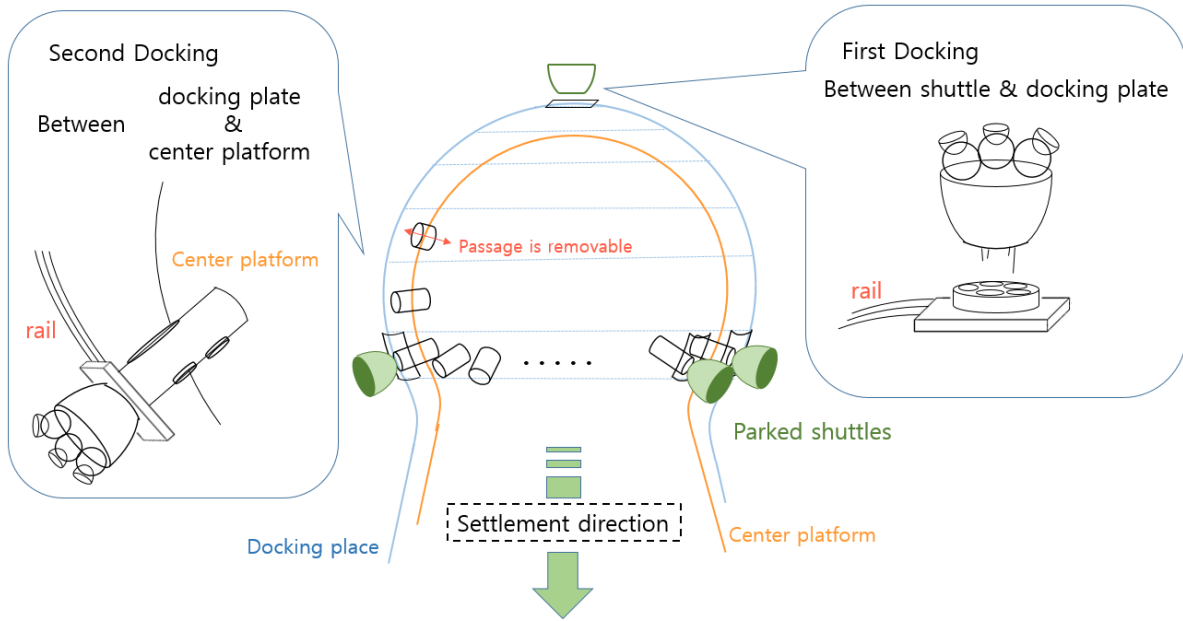

Figure 10. The two-stage process of a spacecraft's docking to the settlement

As there are multiple docking plates that locate at the MDBP, the skeletal structure is composed of 300 blocks. Each block is an 5m-by-5m surface space that accommodates for a single docking plate. Three rows of the MDBP takes up six blocks each, summing 33 blocks blank of space. The remaining 267 blocks are distributed amongst the remaining surface area, each of them allocated a docking plate.

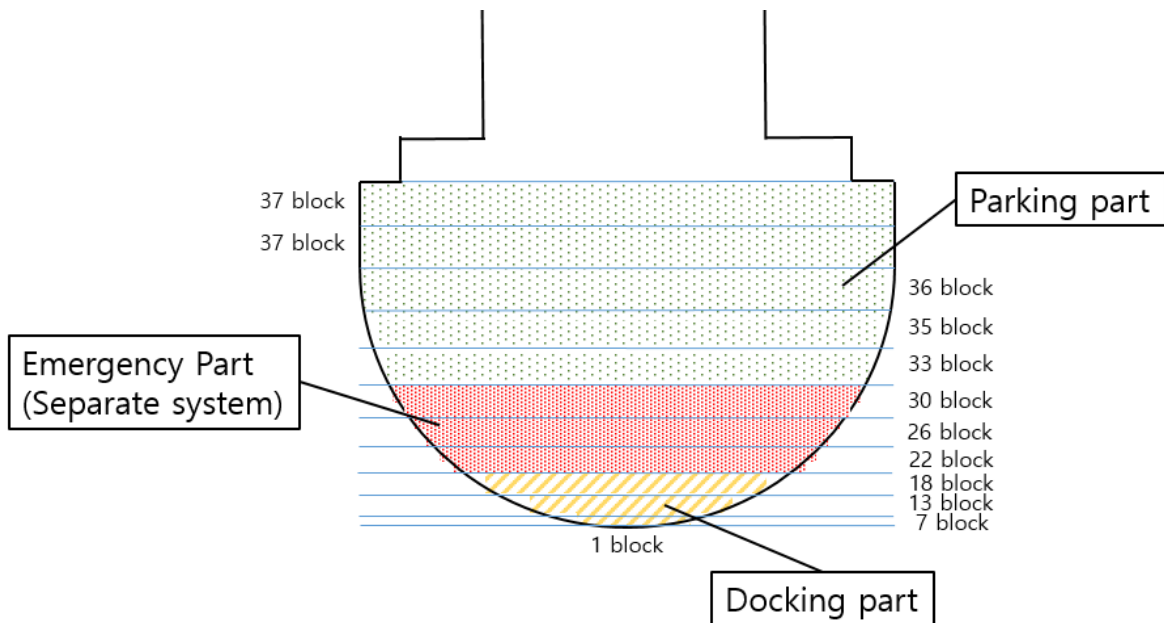

Figure 11. Distribution of parking and docking blocks on the docking port.

Each block on the spherical exterior surface of MDBP create virtual gridlines on the hemispherical structure. Accordingly, each plate's location can be represented with the value of line and row. Mathematically, this means that any relocation of a docking plate on the surface can be

completed less than four moves, and for transfer between the docking port and parking lines, two. This enhances continuous docking operations, thus saving a whole lot amount of time and enabling rapid evacuation in contingency situations as well.

2.8.2. Docking Mechanism – Gears

Using the railway formulation on this docking station allows smooth and efficient maneuvering of the plates and connected spacecraft. On the other hand, operating the plates on the rail requires massive electricity supply(constantly) and causes abrasion of the rails, requiring frequent maintenance. Therefore, we've looked for a difference to means of controlling multiple docking ports, and decided to modify the shape of the plate. By making each plates to have a shape of a gear(cogwheel).

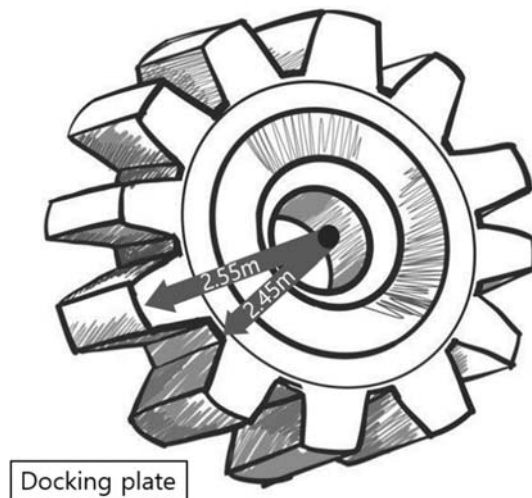

Figure 13. Shape of the gear-shape docking plate

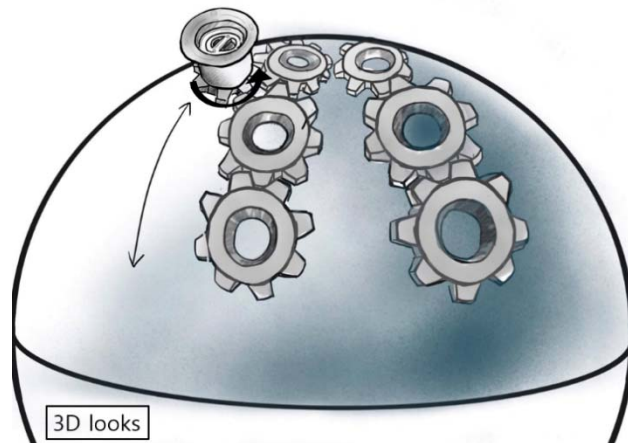

Figure 12. 3D schematic of the operation of the gear docking system

With this shape, the docking plates can easily slide across the surface of the station after docking with the spacecraft, joining with other docking plates (also in shape of a gear). This design enhances the performance and stability of the operation by allowing great torque input.

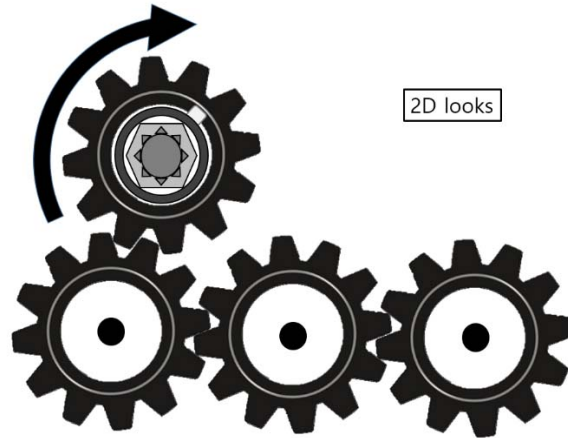

Figure 14. Operational scenario of the gears

If all the gears are adjoined on the surface of the spherical docking station, it would be impossible for those docking plates to rotate and move across. To address this problem, we built an electric hydraulic piston on the substructure to push the plates 'up' to remove them from the link of the gears. The removed gear can then transport to the desired location without being blocked by other plates. By using the railway system, the end of each four rails were as far as individual plate could reach. However, in this design there are four extended semi-rows starting from the 8th line on the parking area. Total of 64 blocks are allocated to the rows (16 for each) and the total docking plate count is increased to 231. Maximum number of shuttles that can be docked at once is 158.

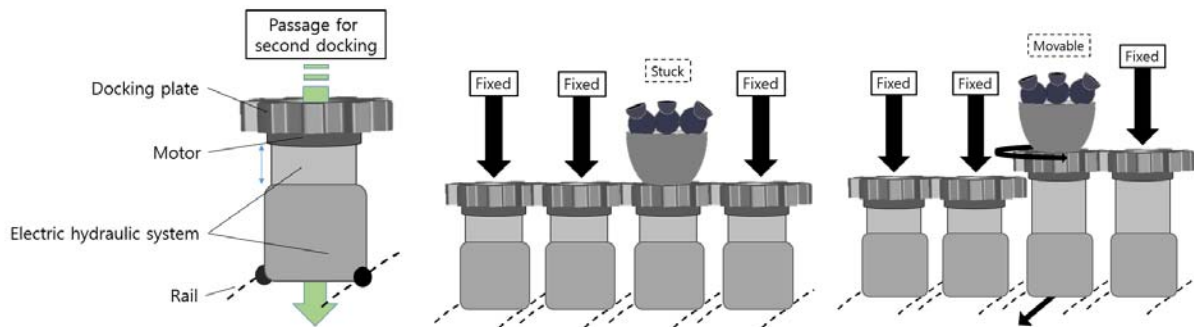

Figure 15. Method of transporting docked spacecraft in a gear docking system

As the mechanism of the docking station changed from railway system to a multi-linear gear system, the way docking plates move from one location to another has also changed. While the rail system is quite straightforward and more suitable for smooth operation, this mechanism is relatively complicated and to relocate each plates have to be separated from the link. Also as all plates are initially linked together all over the docking station, only the half of the total gear system can be used to dock.

2.9. Debris Shield

Great privilege that the Earth's thick layer of atmosphere provides for us is not just limited to 1 atm of atmospheric pressure and letting us breath easily. Each year up to 15,000 tons of meteoroid objects enter the Earth's atmosphere [15], most of them disintegrating to dust due to extreme aerodynamic

heating within their few seconds of entry. Meteoroids travel with a velocity varying from few km/s to tens of km/s, the fastest of them at around 40 kilometers per second [16]. A single meteoroid weighing 100g that travels with a velocity 20km/s has 40,000 kJ of kinetic energy, equivalent to 10 kg of TNT's explosion. Now, over 6000 near-Earth meteoroids with a diameter larger than 50 meters – asteroids that can penetrate and survive Earth's atmosphere – are being tracked [17]. And more than 90 percent of the existing NEOs (Near Earth Objects) are being tracked. As remarkable as it may be, this does not necessarily mean that the Earth is safe from those threats but contrarily indicate that there are that much amount of potential danger that can arise in the future. While the Earth's surface is protected by the atmosphere and is relatively safe from them, Divinity, a feeble and unsecured settlement floating up on the ELEO is definitely under a great threat. Without the privilege of the atmosphere, the settlement must acquire its own independent protection mechanism to protect the torus, structures and the residents within from such grave danger. While every compartments of the settlement are constructed with durability against exterior impacts and dangers, to ensure safety the Debris shield is built around the outer rim of the torus.

Prevalent spacecraft and space habitation facilities (modules of the ISS) employ the 'Whipple Shield' mechanism as a protection against space debris and meteoroids. The Whipple shield uses two layers of metal armor separated few centimeters apart. In this mechanism the outer (initial) plating absorb the impact of the object, disintegrate it and diffuse the fragments to a wider angle, while the inner (secondary) plating finally absorbs the impact of the fragment clouds. By this simple modification to the simply single-layered plating, the Whipple shield saves great amount of mass and endure many simultaneous exterior shocks. This truly is a great candidate mechanism for Divinity's debris shield, as it is mass-efficient and cost-efficient (regarding the launch cost per kg).

However, as confirmed by its use in the ISS, the current design of Whipple shield fails at enduring continuous impacts and shows greater weakness against the projectiles larger than few centimeters in diameter. Unlike the ISS, Divinity is at a higher operational altitude and more vulnerable against meteoroids and micrometeoroids [18]. Also, with its bulky size maintenance of the structure is not feasible. It leads to the conclusion that a better designed protection mechanism is required.

There are few tens of variations of the Whipple shield alone in the ISS, of which the stuffed Whipple shield stands as the most intriguing. This enhanced design fills the gap between two layers of plating with fabrics or fibers such as Kevlar to absorb the fragments and their momentum before it reaches the second plating. This configuration improved the protection against most ranges of micrometeoroid by almost twice as much, and although it is still not enough for use in Divinity it suggested great potential to us. And we came up with the result resolution is the Active Protection Mechanism(APM).

The Active Protection Mechanism (APM) incorporates a similar multi-layer breach-safe barrier structure, capable of stalling or perfectly preventing the air leakage and the breach of the damaged panel. While the initial goal of developing this mechanism was to build an effective protection to be used at the debris shield, it later turned out to have great utility for the major hull components of the habitation compartments as well. This formulation consists of: 1. The Exterior plating, 2. Reactive Plating, 3. Kevlar mesh body, and 4. Dual-layer inner plating's.

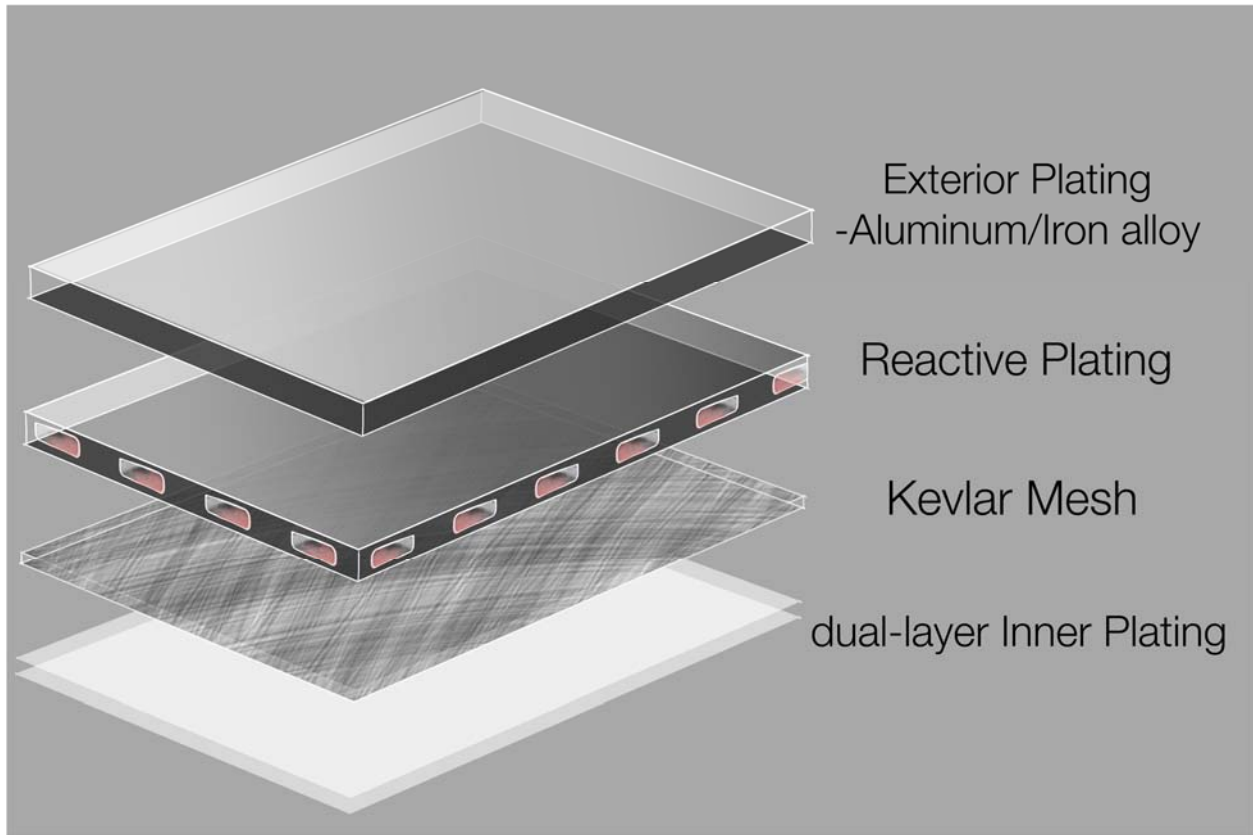

Figure 16. Configuration of the Active Protection Mechanism (APM)

The outer plating and the inner plating's are in essence aluminum alloy. The exterior plating is anodized at the surface to endure constant microscopic dusts and heat, and is capable of enduring impacts from most micrometeoroids. The core element of this mechanism, the reactive plating, is a tempered engineering plastic layer. Densely inserted adhesive vessels inside the layer make this plating 'reactive', and are the key to the highly effective protection this mechanism provides. It is attached adjacent to the Kevlar mesh underneath and two layers are set 2 cm apart from the Exterior plating. Inner plating is low-ductile aluminum/titanium alloy and bears the momentum of the projectile.

The mechanism of 'active protection' is quite simple. The exterior plating is durable enough to survive most of the minor impacts. However, some objects have high enough velocity to penetrate and drive through the outer plating. As the penetrator collide with the reactive plating – or possibly penetrates – it breaks the adhesive vessels, causing them to leak and sip around the impact region. As they leak out to the vacuum and around the spot, liquid adhesives boil and create a foamy outline around the penetrated area. Initially this creates the barrier of gas leakage and prevents the hull breach caused by the excessive pressure applied to the penetrated section. Similarly, the adhesives that had flown to the substrate layer, the Kevlar mesh, would fill up the mesh and amalgamate. The reinforced Kevlar layer would substantially increase the durability of the damaged region and maintain constant durability. This Kevlar layer's durability is comparable to that of a CFRP⁷ and as the adhesive covers the entire

⁷ Carbon Fiber Reinforced Plastic, a composite material consisting of various carbon fibers and thermosetting resins

area, a small breakage can be safely mitigated to hold up for a quite an amount of time until the regular settlement maintenance takes in place.

3. Supporting Infrastructure

3.1. Terrestrial Infrastructure

In the 21st century, the diverse array of demands and products mean that every society is intertwined with each other in the form of material and intellectual trade. Divinity is of no exception to this rule, with its location – Equatorial Low Earth Orbit – making it all the more profitable to maintain close ties with markets both terrestrial and extraterrestrial.

The relationship between the Earth and the settlement is spread vastly among different interests by a very wide level of the subjects, from general residents of the settlement to the entire infrastructure of the settlement. As for Divinity itself, the early construction process involves intense and continuous cargo ship launches as prefabricated structural components and materials will be supplied from Earth. This clearly shows the need for a reliable and capable transportation infrastructure, and apparently the issue is not limited to Earth-to-orbit launch system. Long range spacecraft and versatile Earth transfer vehicles are required as well, and this section will discuss the solution that addresses the issue proposed.

3.1.1. Launch Vehicles

Launch vehicles are significant in that they are the only option for carrying the first part of Divinity and passengers to Earth orbit. While other parts may get built in space or be made from extraterrestrial materials in the later stages of construction, launch vehicles will never lose significance in that it is the only viable method to carry passengers to and from the settlement to Earth. Divinity not only serves as a second living home of humanity, but also as the first platform for humanity's outreach to deeper space.

3.1.1.1. *Background*

In designing the requirements for launch vehicles for Divinity's construction and transport of passengers, the authors of Divinity chose to consider in great detail the characteristics of the International Space Station (ISS). As the largest space habitation facility ever built and the only contemporary existent space habitation, ISS is a notable specimen to Divinity

ISS was built by multiple cargo vehicle launches, most of them supplied by the famous space shuttle launches. Construction began with the launch of the Zarya module carried atop a Russian Proton rocket, soon followed by 35 Space Transportation System (STS) launches [19]. These launches delivered prefabricated ISS modules and facilities to 400km altitude orbit, resulting in the 22 modules that consists ISS as of 2011 [19]. Divinity also aims to source a great portion of its structures from Earth. Yet to do so taxes heavily on the existing launch vehicles' capabilities. Therefore, the authors of Divinity took to research a different type of launch vehicles that could make construction of Divinity through terrestrial launches highly more economical.

Note that while Divinity will offer the possibilities of such launch vehicles and provide the means to support their works, it is up to time and industry partners to see if such vehicles will see the light of reality. It may be possible that other form of launch vehicles, such as reusable rockets being developed by SpaceX, can provide similar capacities and cost as denoted further in this section.

3.1.1.2. *Staging*

Conventional launch vehicles, most symbolically represented by the Soyuz – TMA and Space Shuttle – STS projects, are generally composed of multiple-stage boosters and orbital vehicles (or operation vehicles). This universal design is based on a simple but powerful mechanism – getting rid of the mass that is no longer of use to the vehicle. Stages that are fully depleted of fuel are jettisoned to dispose unnecessary mass and maintain high thrust so as to achieve and maintain sufficient escape velocity. This mechanism is adopted in numerous space launch vehicles as it's highly fuel-efficient compared to other types of launch vehicles. Multiple-stage rockets are in general distinguished to two types: tandem staging and parallel staging. Although not all launch systems have a purely single type of staging mechanism, and hybrid form of them are also being widely used.

Tandem staging, vertical staging, is most commonly represented by the Saturn vehicle deployed during the 1960s and 70s. Unlike parallel staging where all the engines of each stages can be ignited to produce effective thrust, in tandem staging only the lowest stage of the rocket has a thrust system, thus burdening immense gravity load to the lower stage phase and decreasing the efficiency. Also the staging procedure is highly complicated and each staging process induces inevitable flight course discrepancy. Due to these disadvantages we've decided to exclude them from the viable launch system for Divinity.

Parallel staging design is relatively more reasonable compared to tandem staging; the vehicle may achieve high-efficiency thrust from the liftoff to throughout the entire flight, and the reliability and safety of the vehicle is much better than the tandem staging mechanism. Ariane rockets, SpaceX Falcon family rockets and Space Launch System (SLS) family are good example of staging rocket systems with tandem-staging mechanisms. The Falcon family developed by SpaceX has been gaining great recognition in recent years with it being the only operational rocket family to be reusable via vertical landing after entry into orbital trajectory as of 2015. Most parallel staging rockets are evaluated to be reliable and are notably efficient. However, there are few reasons why they are not suitable for operations of Divinity.

For one, the system is hardly reusable. Of course, they can be made reusable with careful engineering with Falcon 9 by SpaceX has succeeding in landing back on Earth after its mission ⁸. However, rockets with conventional design characteristics contradict the efficiency of the vehicle as a cargo carrier. The vertical cylindrical shape inevitably limits the cargo space to the upper part of the structure, thus destabilizing the vehicle's attitude. It not only affects the physical status of the rocket but also limits the volume and dimension of the payload. This directly leads to the inefficiency of the system, and turns out to be a great sacrifice as a cargo that Divinity needs in trade of impractical reusability. Still we apparently need a reusable spacecraft that can perform continuous tasks over a long period of time. Most re-entry modules are engineered to acquire only minimum mechanical durability to secure the safety and turn useless after the mission, even if they return in a sound single piece. Building a new

⁸ On 22 December 2015 at around 1:00 UTC SpaceX launched an upgraded Falcon 9 rocket from Cape Canaveral Air Force Station into low Earth orbit. After completing its primary burn, the first stage of the multistage rocket detached from the second stage, changing its course back to Cape Canaveral. It then unfolded its “legs”, successfully landing on Cape Canaveral's launching pad at around 1:40 UTC on December 22. Stage two successfully deployed eleven communication satellites for Orbcomm. [47]

spacecraft every single project presents immense financial drawbacks, and even if given sufficient budget, manufacture of the rocket is a highly time-consuming process.

Our solution to the problem can be demonstrated by the space shuttle program (STS). As a derivative mechanism to the parallel staging system, space shuttles have proven to be extremely powerful and capable ‘shuttles’ of space. Two solid rocket boosters and the main engine provided with fuel from the external tank thrust the massive 2000-ton vehicle up to Low Earth Orbit (LEO) or Geostationary Transfer Orbit (GTO), with a maximum payload capacity of 27-ton and 4-ton to each orbit. In actuality the payload capacity is secondary to the space shuttle’s major advantages – its capability as a massive ‘truck’ cargo vehicle and reusability. Space shuttles supplied a total of 35 missions to the ISS, delivering numerous facilities and gadgets and sending several hundreds of astronauts to space. [19] The cylindrical cargo bay could accommodate pressurized ISS modules and the Orbiter Vehicle (OV) could return to Earth with maximum of 14-ton payload. While the STS project has concluded with the last mission of a space shuttle Endeavor, basic technologies and propulsion systems of it were salvaged in countless future space vehicle system due to its reliability and efficiency. We found STS’s system to be very attractive and beneficial to the operation of Divinity. However, we did not stop there but looked out for more improvements that can be made. Though the space shuttle’s design is still valid, its original center-of-gravity-and-propulsion-direction issue as well as the actual flight economy issue makes it not perfect as the choice. It is preferable that the cargo vehicle would have larger payload capacity (up to hundreds of tons) and is acquired with a mechanically stable cargo system. And that is why we designed the Massive Earth Transfer Vehicle (METV) system.

3.1.1.3. Massive Earth Transfer Vehicle System

Mechanical properties of prevalent rockets are the main factors that make this specific mechanism especially unsuitable for use in construction projects-they cannot carry massive bodies to outer space. Majority of prevalent rockets are used as astronaut transfer vehicle or payload delivery vehicle-most of which have terminal orbiter vehicle of highly limited dimension and volume. This is due to the basic mechanism of the launch system-the high-speed launch. To achieve the escape velocity so as to enter the Earth’s orbit, most rockets have high-thrust propulsion with acceleration around 4 to 5 m/s² and small cross-section. But surprisingly, such mechanism is not the only way to reach outer space, contrarily to the common belief. It is also inefficient and in numerous ways disadvantageous-for instance, the aforementioned restriction to the dimension of the rocket. The contrast to this is a constant propulsion mechanism which Divinity’s MTEV adopted.

As abundantly explained, this MTEV should be able to carry massive cargos to the orbit, most of which are delicate and fragile components that will be used to construct and compose the hull of the settlement. For such cargos the constant vibration and extreme condition within the conventional high-velocity rocket would be harmful and inappropriate. On the other hand, constant acceleration has minimal mechanical disturbance during the flight, require significantly less thrust (more effective fuel consumption) and mostly, does not limit the dimension nor specific design of the craft. As the vehicle gradually accelerates much moderately compared to the sky-soaring rockets, it will not face major atmospheric drag throughout the entire flight. By the time a vehicle reaches significantly high velocity, the atmosphere at that altitude should be extremely thin that there is no worry about the friction and drag. Up to 30 percent of the gross kinetic energy of the rocket is spent on putting up with the air drag. This means that even taking into account that the total flight duration is longer than the ordinary flight,

this mechanism benefits up to extra 40 percent of fuel efficiency, theoretically. At the same time, the need for sturdy and durable structure is also eliminated as it does not have to bear severe gravity load by the extreme acceleration, also decreasing the gross mass of the dry mass. In conclusion, constant thrusting is a feasible solution to the MTEV.



Figure 18. Side transparent view of the fully composed MTEV

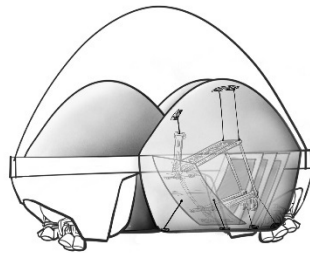

Figure 17. Depiction of the cargo capsule with loaded payload

Figure 17, Figure 18, and Figure 19 depict the general dimension of the MTEV. It is composed of a Versatile Capsule Module (VCM), Integrated Capsule Mount (ICM) and Propulsion Units (PUs). The triangular mount is able to hold three VCMs, each of them of which may or may not be the same variation. The VCMs are configured differently for respective missions. The propulsion unit is supplied with the fuel (LOX⁹ and liquid hydrogen) from the mount, and has three vector thrusters each with two additional MMH¹⁰/composite RCS¹¹ engines.

⁹ Liquid oxygen

¹⁰ Monomethyl Hydrazine

¹¹ Reaction Control System

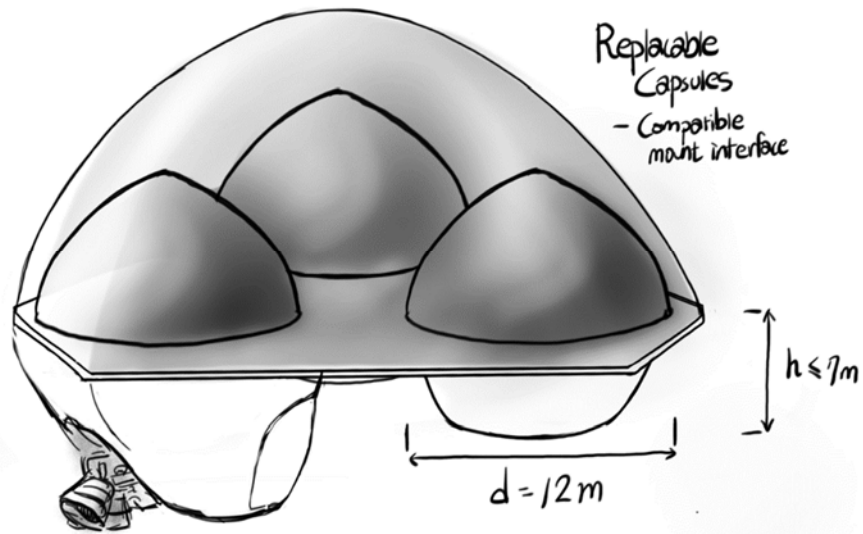

Figure 19. 3rd person view of the MTEV from above with a single propulsion unit installed. The other two propulsion units are omitted to depict the underbody of the capsule mount

3.1.2. Space Cannon

The Earth is a home to all the industrial foundation and development humanity has achieved. And as the Earth seems to remain advantageous for near future, majority of further industrial movements would take place on Earth as well. For both human resource and materials, the transportation to and from Earth should be kept fluent. While rocket launch vehicles are qualified as the viable means of transportation, they are very costly and have not achieved reliability. Therefore, Divinity is planning to adopt entirely different method of sending materials outside to the destination – a cannon. The Space cannon is a gigantic rail gun with a 9-kilometer long acceleration rail, and it will be transporting raw materials and objects that are thought to be able to endure or not be affected by the extreme acceleration of the cannon. Built up with 4 linear synchronous motors, the rail gun can launch up to 1 ton of payload at an acceleration of 10km/s^2 . The launch vehicle has a shape that resembles that of a telephone pole, and can reach the escape velocity with only 3 percent of mass loss and 80% energy efficiency [20].

Although the main purpose of this cannon is to transport the payload to the settlement, the actual operational performance of the cannon can be moderated. On the 9 kilometer acceleration rail, the “basket” which surrounds the payload is accelerated for 7 kilometers. After the separation and launch of the payload, the “basket” decelerates with a rate of 20 km/s^2 , and reverses direction to be reloaded. Each payload launch containers are charged with 100kV of electricity, and passes through the capacitor plate and acceleratory coil on the rail. While advancing, payloads are precisely maneuvered by laser scan and attitude control to be set on the precise trajectory.

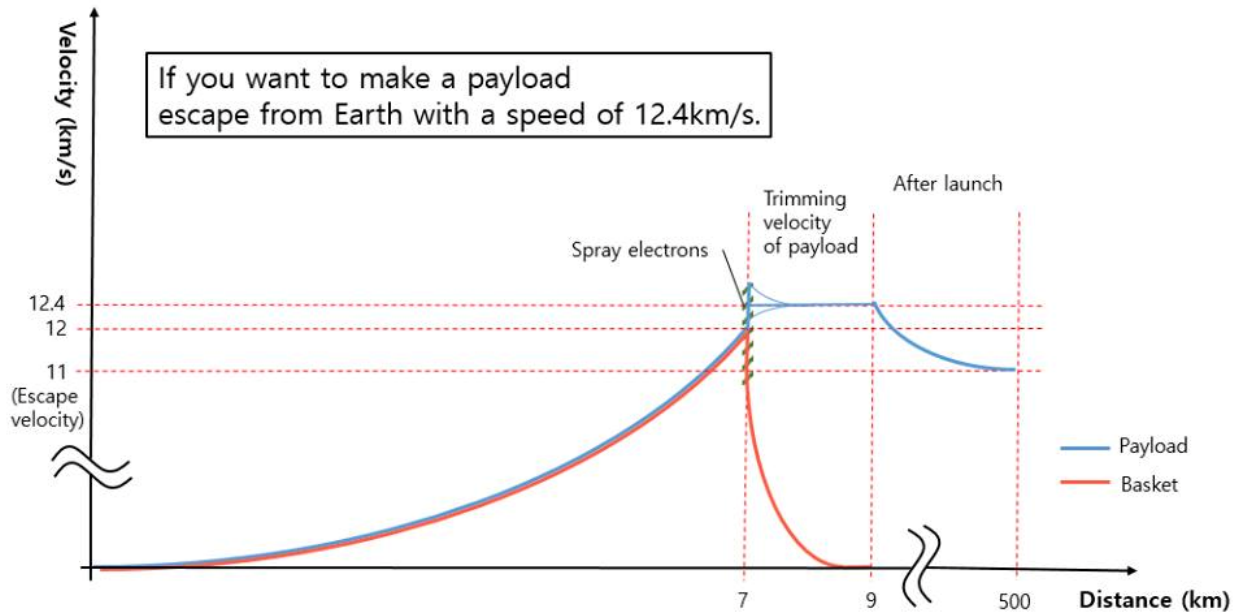

Figure 21. Velocity of the "basket" and payload to distance from reference point of the space cannon. Velocity of the "basket" is shown in red while that of the projectile (payload) is shown in blue.

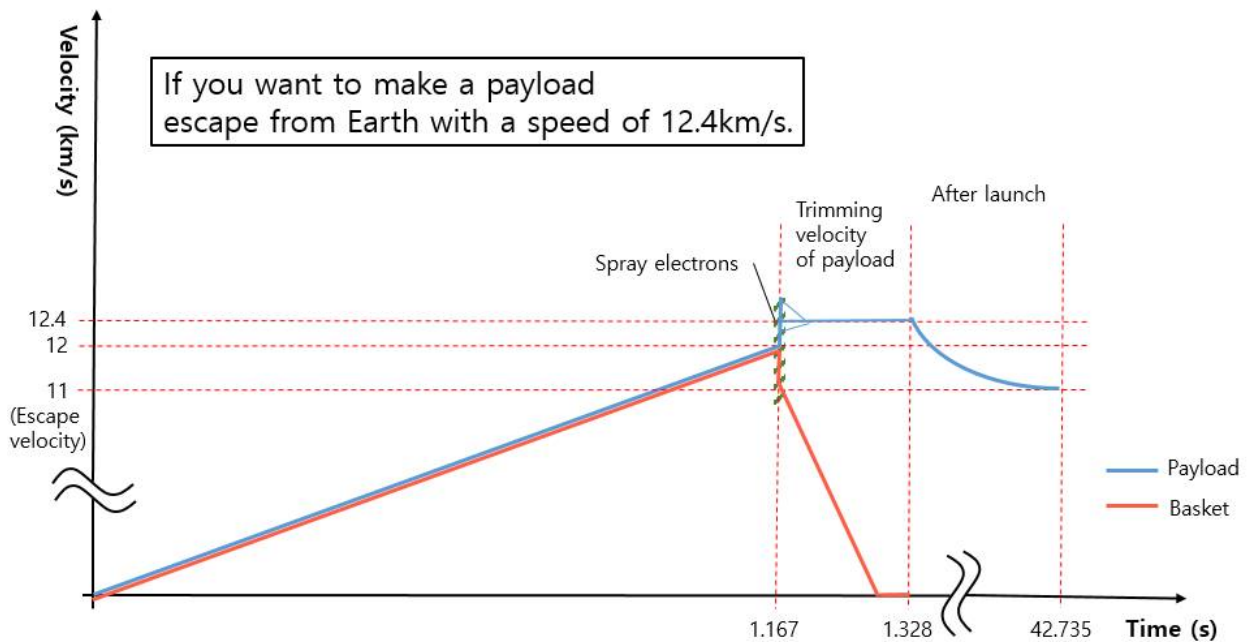

Figure 20. Velocity of the "basket" and payload to time of the space cannon. Velocity of the "basket" is shown in red while that of the projectile (payload) is shown in blue.

The launched payload has to decelerate before approaching the near-Earth orbit and be captured by the Receiver module. The Receiver minimizes the impact momentum by using spontaneous RCS with remote object sensor to captures the payload inside a 3-meter by 3-meter helical Kevlar bag. The captured payload is picked out of the bag by a robot arm attached to the Package Transporter and loaded into the cargo bay. The cargo is then finally moved out to the settlement location. Once the

object is loaded to the cargo, the arm retracts back to its original position and stand by for the next object. This capturing process is estimated to be 3 minutes at minimum, after whose completion is confirmed can the next launch take place.

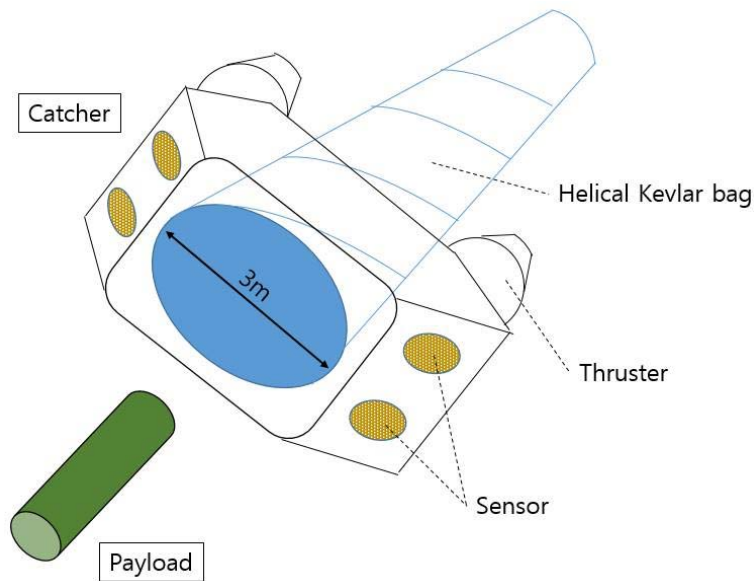

Figure 22. Diagram showing the basic properties of a Retriever module. Note the 3-meter helical Kevlar bag

3.2. Lunar Infrastructure

The moon bore numerous asteroid collisions and meteor showers for hundreds of thousands of years and developed countless craters. Yet even from this activity, there are no winds or natural phenomena that mixes the composition further, which conserves most of the elements of the collision to that impact point. This makes the lunar mining to be incomparably easier than the mining on Earth – in fact, the process is hardly ‘mining’ the materials, and is more like ‘collecting’ them. Countless invaluable resources (most of which are minerals and silica as well as Helium-3) are spread across the surface, making the moon a lucrative location for a resource supplying base.

Prior to constructing the full-scale lunar base, basic infrastructure need to be established. Engineers, executives and mining specialists also arrive to the prefabricated base with Lunar Transfer Vehicles (LTVs). Their objective is to explore the surface of the moon to locate ideal spot for the construction of the lunar base, which must meet the following requirements: a. a wide open plain suitable to build lunar mass drivers, b. geologically stable and confirmed to be rich in utilizable resources, and c. where the direct trajectory headed to Earth can be acquired for the mass driver. The field expedition mission is recommended to be no longer than 13 days as the delivered prefabricated base cannot provide enough protection nor fatigue alleviation. However, considering that the initial deployment of the preliminary operation is likely to be based on thorough background researches, it should not take long for the mission to be completed.

Once the location of the lunar base is decided, every other component will be delivered to the moon, from assembly robots to mining robots and the rest of the lunar operation employees. Receiver units and Space Transporters also arrive on lunar orbit. After the construction of the space, 3D printer components and prefabricated hull components are launched to finish the construction of the lunar base.

Although it's preferable that all the transportation is done with the space cannon, there are still needs for conventional rocket launch for the more delicate parts.

The lunar base will be equipped with mining infrastructure, mass driver that transports raw materials and other subsidiary support facilities. Residential areas are provided to accommodate large workforces for a long mission. Made from 3D-printed walls that uses compressed lunar regolith, the base is resilient and protects the residents from the exterior environment. Mining robots and related gadgets (e.g. spacesuits, apparatuses) are stowed at the storage facility at the base, and the basic processing plant is built near the mining site to granulate or sort the collected materials. This processing plant separates lunar silica and delivers them to packaging facility which then compresses them to fabricate a package for payloads.

3.2.1. Lunar Mass Driver

Unlike the space cannon, the flight time of the launched payloads of the mass driver on the moon is quite lengthy. During the flight, the low-velocity payload is prone to be affected by the gravitational influence around the trajectory. Therefore, the operation of the mass driver requires extremely precise and elaborate pre-launch calculation. The trajectory is determined by a super processor unit linked to the massive data link that contains the information of the planetary movements, surroundings and the coordinate of the Earth's receiver. Even with a powerful auxiliary system, still the margin of error at the arrival location can be as large as 500 meters and raises the need for a larger and mobile Earth receiver unit.

The mass driver is powered with a tokamak¹² energy plant. It is operated from helium-3 extracted from the lunar regolith and outputs 2000 megawatts (MW) of power supply to sustain the spur of the launch. Massive hyper-capacitors store the outlet of power in order to prevent the power loss of the lunar base.

The mass driver is a smaller derivation of the space cannon. The major differences between these two are that the mass driver is shorter than the space cannon with a full length of mere 500 meters, and is built in an environment with gravity of 1/6th to that of Earth. The maximum payload capacity is half of the space cannon's capacity – 500 kilograms, including 25 kilograms from the package container. The smaller payload capacity is a result of a consideration about the retrieval mechanism of the moon-to-Earth transfer system. The payload launched with a velocity to only slightly pass the L1 point should be able to be dragged by the Earth's gravity and eventually fall to Earth. Therefore, an excessive amount of acceleration is unnecessary for the mass driver, allowing the launch system to be significantly smaller. The capacity of payload was moderated so as to minimize the environmental adverse effects caused by a constant cargo arrival.

The mass driver accelerates the payload by 10km/s² at the 120m of point of acceleration at which the payload reaches a speed of 1.57 km/s. As the dense electron flow is applied the payload gets charged to 100kV and is propelled from the basket in less than 0.03 seconds. In this process it gains extra acceleration and enters the capacitor section of the rail with a velocity of 1.6 km/s. For the last 380m the rail aligns the payload and calibrates the course with laser scan control to achieve the target trajectory. The basket which provides the initial thrust decelerates with four brake propulsion system and retracts to the recharging point at the beginning of the rail. The mechanical reloading system is

¹² A tokamak (Russian: токамак) is a device that uses magnetic field to confine plasma in the shape of a torus. Achieving a stable plasma equilibrium requires magnetic field lines that move around the torus in a helical shape.

automated to complete reloading in less than three seconds, allowing a burst-shot launch of massive cargo load. Liquid helium is used as a coolant for the superconductor that operates the mass driver. The cooling system uses a closed-pipe mechanism to sustain the inner pressure that the evaporated helium loss will not heavily burden the operation by requiring additional liquefaction.

As the mass driver is small compared to the space cannon, it does not need to be fixed to the surface of the moon. Rather, the driver is lifted above the ground, giving much-needed additional accuracy when aiming the driver. By rotating the substrate of the mass driver the trajectory can be modified up to two degrees horizontally, which decreases the reloading time of the driver to 13-20 minutes.

The launched payload package passes the L1 with a minimum velocity, and then is reaccelerated by Earth's gravity. After reaching the Earth's effective gravitational area, the package initiates re-entry and land on the receiver platform constructed at the middle of the Pacific Ocean. This 2-kilometer by 2-kilometer platform is a shock-absorbing structure that alleviates the shock of an impact and minimizes damage to the surrounding environment. The package lands on Earth similar to the landing of a meteor, at a rate of once per day according to the Earth's rotation and the moon's orbiting. Each burst-shot packages descend with 0.5 second delay to the last one for 13 minutes, summing up to a total delivery capacity of approximately 700 tons per day. Automated retrieval system collects the delivered cargos and transports them to industrial facilities. The operational cost for each launch is anticipated to be less than few dollars at the time the entire infrastructure is established and functional.

3.2.2. Lunar Space Elevator Infrastructure

The moon is a great strategic asset to Divinity, both economically and in operational sense. Mineral resources from lunar regolith can be processed at Divinity or directly exported to Earth for profit, and can also be utilized to acquire construction materials or raw materials for the industry at Divinity. Thus an efficient and reliable means of transferring resources from moon to Earth is essential. We've sought for a viable solution, and our answer is LSEI, the Lunar Space Elevator Infrastructure.

The theory of the space elevator's operation is similar to that of the tides on Earth. That is, center of gravity of the elevator is designed to be placed at the equilibrium of Earth's and moon's gravity. Such location is called the Lagrangian point, of which there are five Lagrangian points to every system with two major massive bodies.

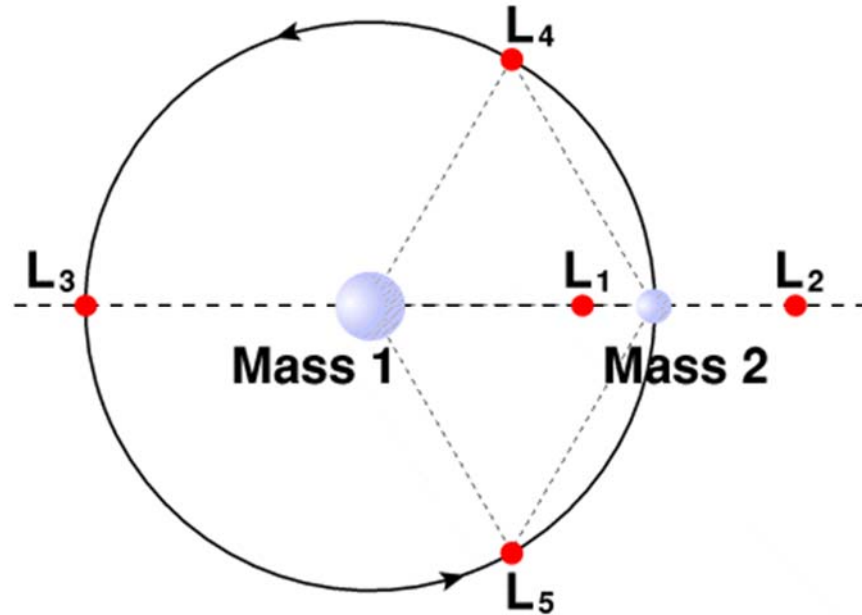

Figure 23. The Lagrangian Points of a two-mass celestial system [48]

In Figure 23, Mass 1 represents Earth and Mass 2 the moon. The markings with L- prefixes are the five Lagrangian points, of which L1 will be the construction point of LSEI. Two reasons dictate that it should be built at L1.

The first is its efficiency. Unlike conventional satellites and spacecraft, LSEI allows the genuine zero-gravity experience. Generally orbital satellites use gravity as centripetal force to keep the rotation motion, experiencing the so-called ‘microgravity’. As the elevator is constructed right between the moon and Earth, this means that, theoretically, there is literally no net gravitational influence to the object in it and limitless amount of mass can be placed without any hindrance. Although the zero-gravity property applies at one size-less point and its exact location is perturbed by the other celestial objects’ gravity, there still exists a zone that approximates to zero gravity. It is an academically rare and valuable environment that can be harnessed for numerous previously impossible experiments. For instance, in such gravitational equivalence, it might be possible to reenact and perceive the gravitation wave interference. Being on a lunar synchronous orbit is also a great advantage that should benefit researches in the field of science.

The second is feasibility. Divinity is located at ELEO, whereas L1 is located between the Earth and the moon, meaning that the elevator connection between the Earth and moon must be highly efficient, almost in a direct transfer route for materialistic support of Divinity. Needless to say, the shorter the distance, the better the efficiency. Tension between two body’s gravity increases as the distance from the Lagrangian point rises, and consequently the ribbon must not only be lengthened but also expanded in diameter. Zylon, the main substance for the ribbon, is produced under highly delicate processes and minimizing the need for materials should be a great benefit.

The last is the stability of operation. The moon has a rotation period of 27.3 days, exactly the same as its sidereal period of 27.3 days, and therefore only the ‘front’ of the moon is displayed to and observed from Earth. While the lunar surface is generally covered with numerous craters, the probes sent to the

back of the moon (relative to Earth) showed significantly larger numbers of craters on the surface. This can be interpreted that the back side of the moon is exposed to more frequent asteroid collisions and to protect the elevator it must be placed inside the moon's orbit. Less collision and threats mean less maintenance, better operation and safety. The figure below(reference)

depicts the magnitude of gravitational influence by a purple contour. There are two deep holes adjacent to the L1 point on the map, which means majority of the asteroid bodies approaching the elevator from any direction should fall under the influence of each mass bodies (the moon and Earth), thus leaving the middle area clear of threats.

Zylon is a cutting-edge technology of a durable composite fiber. Developed by Toyobo corporation in 1998, this fiber is capable of bearing 600kg mass load with only 1.6mm thickness. While CNT (Carbon Nano Tubes) and carbon isomer substances have better mechanical properties, Zylon is durable enough to sustain the elevator and is easier to produce.

Space elevator system requires counter weight so as to maintain proper orbit, and LSEI requires approximately 24 million kilograms of counter weight when the safe factor¹³ is set to two [21]. As the ribbon structure weights around 303,000kg, the entire LSEI system with total mass of 24.4 million kilograms should be completed with 75 cargo shuttle launches¹⁴ [21]. Safe Factor is set to two since ribbon's high stability is essential as per the operational situation where the carrier is constantly relocating, thus bringing change to the CG's location. And for the maximum efficiency, counterweight section is utilized as a facility for human workforces and its weight should vary from time to time-also contributing to the choice of Safe Factor.

The climber module is an unmanned system, fully automated during the operation. Primary function of LSEI is transporting resources from the moon, which does not necessarily require manual administration. The payload is loaded inside a specific container that is manufactured to comply with respective properties of the payload. As climbers enter manned facilities, toxic substances or microscopic dusts are contained in an air-tight container, and combustible materials are treated with extra caution, and so on. Each container is equipped with portable depressurization controllers, which keeps the inside of the container vacuum (to prevent chemical reaction or decay) or infused with noble gases.

LSEI is occasionally used as transportation for working personnel, and there are two scenarios that the elevator (carrier) is used by the personnel. The first scenario is where the elevator is used for a regular (planned) transit. Carrier is equipped with a shuttle chamber equipped with life support system and protection. Passengers may don the spacesuit to engage in an EVA during the transit. The second scenario is where the elevator is unexpectedly providing transportation in emergency situations. This is only allowed under great contingency circumstance or if the shuttle chamber is defunct.

¹³ Safety factor, or the factor of safety, describes the capacity of a system beyond the expected loads or actual loads. The safety factor is how much stronger the system is than it theoretically needs to be for an intended load. The definition used in project Divinity and its calculation source, [21] is the ratio of absolute strength (structural capacity) to the actual applied load.

¹⁴ It is assumed that one cargo shuttle launch will bring 360 ton of material to the lunar surface. The said rocket is the Massive Earth Transfer Vehicle (METV) whose specifications are detailed in section 3.1.1.3 Massive Earth Transfer Vehicle System.

3.3. Asteroidal Infrastructure

Asteroids are composed of rare earths and other materials that otherwise cannot be acquired from Earth or moon. Asteroid mining and subsidiary researches would be highly advantageous, both scientifically and technologically. The Harvard-Smithsonian center for Astrophysics has suggested that mining the asteroids would be extremely beneficial if conducted with proper preliminary research and the exact locations of them are confirmed-only that such tasks are very complicated and cumbersome. Still the value of Asteroidal mining is undeniable. According to Eric Anderson, the representative of the Planetary Resources, there are potential benefit that can be earned from exploiting platinum and massive carbon composite materials [22].

In Asteroidal mining, there are two major technical issue to be addressed. First, as the target region is very distant from Earth, communication system need to be properly designed. Also the communications can be easily disrupted by planetary movements and solar activity. To enable constant and stable communication in the mission, the authors of Divinity has developed a satellite system that will provide communication links between the miners and headquarters. For this system, the authors came to the conclusion that the L5 of the Earth-moon Lagrangian points is the most appropriate location for the satellite. From L5 the most continuous and undisturbed communication channeling is available, and asteroids are highly accessible as well as the Earth.

Mining of Asteroids is conducted over two operation phases, decided by the number/location of the communication satellites and the energy requirements. In phase 1, Comsat is only deployed at L5 to establish connection on the asteroids as the need for connection is lower than it is in Phase 2. As the traffic and work intensity increases in Phase 2, more satellites are deployed at L4 as well to widen the coverage of communication channeling. This promotes better working environment on the mining site by allowing more real-time and precise instructions.

The energy requirements of the operation also decide upon the phase of the operation. The mining requires great amount of energy for transportation and facility operation. Rovers and mining robots on the asteroids are supplied with energy by built-in solar cells or batteries charged with solar cells. While this mechanism promotes independence of each unit, the inborn nature of solar cells discourages its extensive use in mining. Should the power generation of the cells be hindered by the light exposure or panel damage, the unit would be incapacitated and left defunct until the maintenance arrives. This is not the kind of disadvantage that can be risked in a massive mining operation and therefore in phase 2 the robots and facilities will be supplied of power via a solar power satellite. This satellite is designed only for solar electricity generation, and yields much higher output as it is located closer to the sun.

3D printers are the unique utilities that are only featured in a phase 2 operation that use materials processed from the mined raw materials to manufacture components and appliances. Printers capable of perfect metal printing will be introduced in a near future, and they would be a great asset on the asteroids where not much manufacturing facilities nor supplies can reach. 3D printers will be maintaining the infrastructure on each asteroid when the manned technical support and adaptation to the changing operational plans cannot be made. With that being said, the entire infrastructure of asteroid mining is fully automation-based and will not be attended by human workforce on the operation sites except for routine maintenance. This is a logical decision regarding the high-efficiency of automated systems. Even considering that the feedback and effective response about the operation cannot be made but by humans, automating the systems is preferable. Counting the signal processing

time, the communication over the Asteroid-Comsat-Earth system takes from few seconds to minutes. When the manned mission has a benefit of great response time and adaptability, such are meaningless if the communication takes long. Repetitive and uncomplicated tasks such as mining and collecting of the materials is done by automations, whereas maneuvering the 3D printer plans and administration of the system are wirelessly controlled from the Earth.

4. Operations

4.1. Spokes

Spokes are the bridges between the rotating torus and the non-rotating microgravity complex. There are a total of six spokes distanced equally around the perimeter of the microgravity complex, and each has a separate system for the transfer of gas, water, and electricity, as well as for cargo and passengers. All of them will each be designed to support the transportation of supplies for the needs of at least a third of the whole population. This independence will minimize the possibility of a complete supply cutoff emergency. If a channel goes out of service, another will be able to take its place and even transport the materials needed for prompt repair. There will be no hindrance in supplying the required amount of resources for residents.

A spoke has 8 identical rails for shuttles. Since they are all identical, one can be substituted to another without needing any reconfiguration in emergent situations. In normal states, 2 of the 8 channels are always reserved for unprecedented situations, while 4 are used for human transportation and 2 for cargo. All spokes have the dimensions of a square 20m by 20 m, with length of 55m.

4.1.1.1. Fluid & Energy Transfer

Spokes have five resource transfer channels: two main frames, one gas channel, one water & fluid channel, one passenger channel, and one cargo channel. The starting points of all channels connect to the Transport Center in Sector I of the Microgravity Complex. The supply of water and fluid will be controlled by central management with the purpose of maintaining water pressure at a specific level. The central management will also control the amount of fresh air, temperature and pressure depending on the degree of air contamination.

4.1.1.2. Passenger Transfer

The shuttle for passenger transfer will be operated in a system that draws an inner circle. It will connect the stations of the residential area and the transport center. At times with normal amounts of traffic, two shuttles will be going around the cycle, and in the rush hour the number of shuttles will be increased to four. This kind of flexible operation will meet the needs of the residents better than a fixed schedule, and also be efficient in terms of energy and costs. Also, the presence of two input channels and two output channels will help make up for any possible malfunctions. The system on Divinity can support up to 3 broken channels, with utilization of the counter-acceleration technology.

4.1.1.3. Cargo Transfer

Cargo transfers are also operated with the shuttle pathway drawing an inner circle. Unlike the passenger transfer shuttles which were round-edged, cargo transfer shuttles will have distinct angles fit for storing cargo containers and boxes. It will have less operating frequency of about once or twice a day. While cargo shuttles will operate to a schedule, express shuttles can be commissioned when direct and swift transfer is needed. With this operation method, electricity can be saved and the whole system can be maintained with just a small number of shuttles. The emergency plan for channel breakdowns is identical to that of the passenger transfer system.

4.2. Central Hub

The Central Hub is a major transport passageway that consists of 4 rails for passenger transfer shuttles called the Transport Pods, and 2 rails for cargo transfer device called the Transport Arms. The selection of rails is due to the advantage of simplicity. In the complex area of space-like vacuum with weightlessness which is the Central Hub, another way of saying danger is complexity. With the simplicity of the rails, repair is made easy to the best possible extent, securing human safety. The repair itself is quite easy, since the rails made on Divinity would be much suitable than the rails made on Earth.

Repair would begin with checking where the specific problem lies. Regular check-ups will be done by automated systems on the transport pods and robotic arms and will be done without taking things apart but examining their travel without cargo or passengers. X-Rays and frequency checks will be used to check problems within, and lights with various frequencies will examine the frictional wear outside. To avoid problems undetected by check-ups, components will be regularly replaced in 1~2 years. The replaced rails will be recycled to form a new product.

4.2.1. Transport Pods

The Transport Pods are the only place where life-sustaining devices are installed in the Central Hub, due to its function of moving passengers. They will be designed to take in 100 people maximum each, due to weightlessness and the short interval of moving. There will be 4 Pods total. To prepare for emergency, there are 10 trips worth of battery in each pod, and 10 hours of life-sustaining will be made possible for 100 in a state of isolation. In non-emergency cases, the pods will be used by about 10 to 30 people.

Since the interval of moving is quite short, there is no internal air purifier, but a device for removal of CO₂ will be prepared for emergencies, and an emergency supply of oxygen will be prepared in a liquid state at the tanks above. When electricity is cut off or the motor is stopped, transport arms may pull the Pods to the airlock or emergency manual operations with communication with two external experts will help evacuation. This way, the safety of everyone will be guaranteed in any situation. The airlocks connected with the Pods will not take a lot of time to open. With the use of special bearings, these airlocks will be quite advanced in design.

4.2.2. Transport Arms

The design of Transport Arms should come in many varieties, to suit the cargo in any situation. Using robot arms will enable the change in form much easier and thus was selected. This method is better than using carriers, since there are no limitations to volume or form of cargo and the small volume they take up (especially when folded), compared to carriers, will enable efficient use of Central Hub room. Also, the end of the robot arms, or “hands” will be able to be replaced.

4.3. Industrial Complex

The Industrial Complex is where the majority of the manufacturing take place. The capacity supported by the industrial complex allows for great variety of work – from construction of voyager spacecraft for Mars trips to component construction for High Earth Orbit (HEO) settlements – to happen.

4.3.1.1. External Robot Arms

Right outside the Industrial complex, external robot arms will be used to help the manufacturing process. Their structure is modelled after the human arm, while the limbs and mechanism resemble the current forklift on Earth in general structure. Two arms will make one set, and move around on carts to the area in need of support. The carts go around circular rails that lie right outside the hatches of the industrial complex, which also supply energy for the robot arms to move.

Each arm will have two joints, each joint covering almost all of 360 degrees. This will enable the arms to be flexible and effective in their motions. The joints will be hydraulic, with bearings controlled by hydraulic pressure changes. This mechanism is similar for all joints.

Since there are many functions the robot arms need to perform, different shapes of hands will be fitted at the end for different functions.

4.3.1.2. Compartmentalization

The best property of the industrial complex is its ability to support a staggering variety of works, which is enabled by its compartmentalization. Starting from the central hub which extends into the industrial complex, radial walls can be set up that isolates one compartment from the next. Once isolated, the compartment can be left unpressurized or pressurized with normal atmosphere as consumed by the residential area. It can also be filled with special gases required by the specific operation.

The ceilings of the industrial complex are made of independent tiles that were hinged against each other. These hinges were detachable, giving the tiles the property of either the ceiling or the opened hatch, decided by which one stayed attached to the main frame and which did not. This tiled ceiling meant that the workspace could be expanded to compartments of choice if the situation called for any space environments or the finished product was ready for testing. In some cases, whole spacecraft for voyages further out into the solar system and beyond also gets built in the industrial complex, and its deployment could be made in the starward industrial complex with its hatches open.

4.3.1.3. Offices and Airlocks

While the inner circle of the industrial complex is kept clear for access into the central hub, the outermost space was occupied by offices and airlocks. The offices lined the whole outer wall of the industrial complex, and was kept pressurized regardless of the environment into which the office looked. Higher managers of projects would get the field's view of the operations, and the pressurized environment served that managers could check in for progress easily and frequently even when the actual operating space was unpressurized.

The airlocks line the bottom floor of the office and served as a point field workers suited into EVA for work outside in the hostile environment. Even when the compartment was sealed and pressurized with normal atmosphere the airlock would serve as a point of security and personal cleaning into the operating rooms.

4.4. Microgravity Complex

4.4.1. Sector I

4.4.1.1. *Transport Center*

The Transport Center will serve as the heart of connection between Earth and Divinity, since it is the first place visitors will go to just after getting off the shuttle. Even the location will be at the very center of Sector 1. The main function of the Transport Center is to connect the tourists to the residential areas and hotels, but as a place comparable to an airport on Earth, the Transport Center's functions will be quite diverse and unique.

The biggest role of the Transportation Center would be the transportation of people and goods, hence its name. After shuttles dock at the docking port, the next place they go will be the Center. At the center, people can choose to go to hotels or residential areas depending on their purpose. The goods will be sorted into parcels for residents and raw materials to be manufactured at the Industrial Complex, and sent to corresponding locations. Parcels will go through the spokes to the right address, and raw materials to the industrial complex or assembly yard.

Moreover, the Center will have the role of a hub for cargo ships that go through spokes. After the first residents settle in the residential area, the use of big cargo ships will be ineffective and energy-consuming. Therefore, the ship of appropriate size will be used for efficiency, and ships of other sizes will be stored in the Transport Center for use at the right occasions.

Also, the Transportation Center is where the air and fluids are maneuvered to suit human use and sent everywhere humans exist on Divinity. The ratio of components, temperature, initial speed and concentration will all be controlled here. As oxygen and water are valuable resources limited in amount, their efficient management is very crucial. The specific management methods are dealt with detail in other sections.

The ambience of the place will naturally be quite vivid, both culturally and economically. People would constantly be arriving and leaving, not between other cities or countries but between Earth and space. People would be learning how to move their bodies in their destinations in their own languages, and advertisements about tourist attractions will be more intense than anywhere else on Divinity. Shops will be filled with souvenirs and tour brochures with hotel information.

4.4.1.2. *Low-g Sports Center*

The Low-g Sports Center will host the Space Olympics, a major tourist attraction of Divinity. By the participation of originally Earth-living athletes, the meaning of the games will not stop at being exotic and revenue-generating but extend to be a festival of the entire human community. This Center will have fields and arenas for all existing low-g sports, including Quidditch, soccer, and lacrosse. The list of possible low-g sports is expected to increase greatly over time.

One notable characteristic of the center is its location. The Low-g Sports Center will be located at the side of Sector 1 which faces the Earth at the time of the Olympics. This will make easier the live broadcast of games and add a sense of unity and shared passion.

Even at times when the Olympics are not being held, the Center will provide diverse experiences. Athletes who are planning to compete but do not live on Divinity may come practice, and the low-g

sports section of Divinity physical education will be taught at the center. Also, elders may visit the center to be revitalized by the lack of gravity on their muscles and joints.

4.4.1.3. *Starward Hotel*

The name of this hotel covers the special experience it will provide. As a hotel in space with low-g, merely spending a day or two would be extraordinary in itself. Guests learn how to wash their bodies in blobs of floating water, and to strap themselves before going to bed. For this reason, the hotel itself will be a tourist attraction. There will be a large range of guests, from residents who prefer small gravity to fans and athletes participating in the Space Olympics.

The rooms will come in three sizes of single, double, and family. They will also be divided into two types regarding the location of the room relative to the window. In the rooms with windows, guests may look outside towards the seemingly endless space. These rooms will be places of inspiration and curiosities. The possible problems of radiation are taken care of by Divinity glass, which contains lead.

Along with the convenience stores and room services like those of hotels on Earth, the Starward Hotel will go further to provide for guests' unforgettable memories. To begin with, for those who would like to observe the stars, the stargazing lounge will be opened with fine telescopes and detailed explanations by guides. A small low-g gym will be facilitated for simple, safe and fun sports. For children who have never experienced low-g before, small science classes with interesting demonstrations will open, nurturing their curiosity. For adventurous adults, an EVA-like experience will be provided. Guests will be connected to a life string and then let out of the hotel windows to walk along the rails. With no sound, gravity, and nothing behind his or her back, this experience will give the utmost thrill for adventure lovers.

4.4.1.4. *Oxygen Supply*

Keeping the oxygen level constant is essential to life without doubt. Too low levels of oxygen will endanger human life by making impossible for humans to breathe, and too high levels of oxygen will highly increase the chances of fire. Thus, the air of Divinity will have the same gas ratios to that of Earth, as mentioned in the atmospheres section. Fortunately, after the initial conditions are set, the expectations are that not much human intervention will be needed. Since there are plants and crops that photosynthesize, they are expected to consume the little carbon dioxide formed by human breath. To doubly ensure the stability of these ratios, constant checks will be conducted, and oxygen levels will be controlled by adjusting the amount of flora on Divinity.

4.4.1.5. *Food Supply*

According to the predictions above, Divinity should provide their residents hundreds of tons of food every year. However, to provide every gram of food from Earth would cost unnecessary fees and be very ineffectual, due to the possibility of economical loss in prices and accidents regarding stable supplies. Thus, Divinity will cultivate agriculture for food in an area of 2000 square meters with aeroponic methods.

Today, we grow plants in our soil, and it has many problems. Agriculture in soil is vulnerable to blight, the acidification of soil due to overuse of fertilizer, and hardship in hiring managers. Hydroponics was suggested as an alternative to make up for these problems. Hydroponics makes possible complete automation and great effectiveness in room management. However, even hydroponics has its bounds in Divinity hence the great value of water in space.

Therefore, aeroponics is suggested to save water and effectively cultivate food in Divinity. Instead of fully filling pipes for hydroponics, aeroponics makes use of fogs containing nutrients for plants. This way, the root of the plants will have the greatest access to water and nutrients hence the increased surface area touching the fog.

Divinity seeks to combine the best of hydroponics and aeroponics with complete automation by the following process.

Table 1. Stages and process of agriculture on Divinity. The first column denotes the steps, where the end of the last step goes back to the first; the second column denotes the installation inside which the steps are conducted; and the third column describes the process of that step.

Step	Installation	Process
Step 1	Bionursery	In the Bionursery, the plant is grown to the appropriate size for aeroponics, then is moved to the beds.
Step 2	Aeroponic lines	The beds are placed at the aeroponics lines. In each line, a system allows the bed to move from the starting point to the end.
Step 3	Harvesting	The placed beds are moved to the endpoint in regard to individual growth status, exposed to light and temperature fit for its growth stage. The speed of the system allows the unit to be ready for harvest as it reaches the endpoint. The necessary conditions vary greatly among species, so they are to be programmed beforehand. Biological monitoring will enable them to grow at similar paces, and if not, to grow at the most effective paces.
Step 4	Processing facility	At the endpoint, a machine harvests the unit. It is then sent to the manufacturing factory or sent to the Bionursery to begin the process all over again

There are many advantages to this system.

First, the system individualized for each plant is much more efficient than the traditional soil-harvesting. The optimal amount of water containing appropriate amounts of phosphorous and potassium, and LED lights containing only red and blue lights necessary for photosynthesis maximizes the growth potentials of the crops. According to experiments of Cityfarm conducted by the Massachusetts Institute of Technology’s media lab currently done on Earth, the crops grown by aeroponics grow in rates 3 ~4 times faster than the traditional way. To add, waste is minimized, cutting the cost down even lower.

Second, the complete automation of agriculture shuts off the possible risks of blight and human mistakes. They are not dealt with in human hands, and cut off from potentially dangerous situations like contagious diseases. Cost is also decreased owing to the few number of people needed.

Third, effective room use is realized by the stacking of lines. This is most clear when compared to the ineffectiveness of traditional farming where only one floor can be used. There are much less

requirements as a aeroponics farm compared to the traditional method, so if some conditions are met and computers are working, anywhere can be used to harvest food.

Fourth, unlike traditional methods, there is no need to regard the state of the soil. The state of the soil is a serious condition to consider on Earth. For example, if a needy plant is harvested in the same soil for a few times, the land will go barren and need sufficient time or fertilizers to be able to grow plants again. This is quite costly. Aeroponics is completely free from this problem, since soil is not used and nutrients are effectively supplied by a concoction of chemicals and water.

Finally, this system has a very promising future in that it is wide open to many kinds of uses. Since monitoring at very close distances is an important part of this system, the enormous amount of data collected during aeroponics allows productive research in high-tech agriculture. Crops change in taste in regards not only to nutrients but also the environment. With further analysis, consumers both on Divinity and on Earth may have the power to control the taste of their food.

4.4.2. Sector II

4.4.2.1. Sports Quarter

The sports quarter house the two Quidditch stadiums and the sports reserve space. The main Quidditch grounds overlook a vista of the Earth, providing great attractions to viewers on and off Earth alike. Specific dimensions and structure of the sports quarter can be found in Figure 33.

4.4.2.2. Culture Quarters

There are two culture quarters in sector II, the first of which is dedicated to microgravity art galleries and microgravity museums. Its outer panels, covered in glass for the outside view, is filled with artifacts and artworks that let the viewers realize the true value and rarity of such practices. The inside portion of the culture quarter is filled with rooms that are leased to artists who need space to create microgravity artworks, or used by museum institutions to store and prepare exhibitions. Artists' spaces are given greater ventilation and their own water and electric system to make cleaning more effective while rooms leased to institutions are bigger, more versatile and customizable.

The other culture quarter is dedicated to theatre and performance halls. While the outer wall with the windows are occupied by multiple theatres and halls of various sizes, the walls between them could be taken down to create bigger concert halls when needed. The inside section of this culture quarter also houses practice rooms for actor's/actresses musicians and gymnasts with dedicated dressing rooms, soundproof rooms and practice hallways with padded walls.

4.4.2.3. Tourism Quarter

The tourism quarter house the largest microgravity hotel in existent at the solar system. Because of Divinity's unique location, occupants can have the most stunning views of the Earth below, while relatively easy access attract more guests than hotels at other locations. Like the other quarters the outermost space is reserved for its main service – hotel rooms, where the inner parts are reserved for its dedicated restaurants, lobby, casino and laundry and other services.

4.4.3. Sector III

Industries of Divinity are mostly high tech industries, especially those that relate to space development. These industries largely take advantage of the unique environment of Divinity's location and the proximity it has to other outer space resources.

There are largely two macro industrial activities: One is the processing and resource-refining industry, and the other is manufacturing industry based on the processed raw materials. Condition of space gives four reasons why the refining resources should take place at Divinity.

The first is micro-gravity. Without much interference and difficulty that exist under gravity, three dimensional parameters, height, length, and thickness can be easily modified and maneuvered. This enables comparably accurate and efficient processing of the materials.

Second is the vacuum. Chemical industries and other manufacturing systems that involve pressure or temperature conditioning can highly benefit from the vacuum of space. It prevents chemical reactions that naturally occur with reaction between elements in the atmosphere, and thus eliminates the need for extra catalyst input or inactive gas infusion. Reactive and unstable materials that easily decompose or denature can be easily handled in vacuum.

The third reason is the convenience of securing the raw material's property. Constant vibration and external kinetic stimulation is posed to the cargo while transferring long distance to the Earth, which might cause denaturalization of the material.

The fourth reason, stability of transportation, is of similar logic as the third. Though based on a similar idea, this one focuses on the safety of the operation itself. Re-entry to the Earth is a dangerous procedure, and unexpected accidents during the procedure or crash landing can cause disastrous consequences. Not all raw materials are refined beforehand to transportation to the Earth, and those without need for further treatment are directly sent to Earth or the destination.

Manufacturing the products is then distinguished to two types, where one is for the use inside the settlement and the other is for manufacture for the outer space industry. The reason why manufacturing should also be conducted in space is basically the same to those described above. The entire industry is mainly under the administration of the Divinity executives but respective manufacturing projects are private company-based. The migration of offices to Divinity, or leasing of Divinity's facilities are established by a long-term contract between Divinity and the proposing company, and can include fabrication of space vehicles, probes, and space research labs.

4.4.4. Assembly Yard

The Assembly Yard is a part of Divinity's industry infrastructure that specializes in the manufacture of raw material, supply of materials based on the needs of the industrial complex, and the cargo that goes in and out of Divinity. Services like shuttle check-ups and repairs will also be provided by the Assembly Yard.

4.4.4.1. Control Deck

The central roles of the Control Deck are the maneuvering and management of robotic arms and the administration of officers and field workers. And since the Assembly Yard is also used as a port for loading and unloading cargo, management regarding arriving and leaving shuttles will be another job managed from the Control Deck. Managements of other operations that occur around 25 meters of the Assembly Yard, such as the use of the robotic arm elevator at the central hub, will be under the administration of the Control Deck as well.

4.4.4.2. *External Robotic Arm*

The external robotic arms of the assembly bay take on a variety of jobs. For one, they capture cargo delivery spacecraft and move them closer to the central hub where other robotic arms or field workers in EVA will unload the cargo. They support assembly or primitive structures that does not require the high-intensity workforce of the industrial complex, or is for export back to Earth. And they also move tools and astronauts around for assembly of said structures, maintenance of spacecraft, or loading or unloading of cargo. The external robotic arms are controlled by robotic arm control officers situated in the Control Deck, and are installed along the control bay.

The arms work with hydraulics, and can move like an excavator of Earth. The central model of the robotic arm is the human arm joint, and each robot arm has three joints that allow the robotic arm to function like a human's that has joints at the shoulder, elbow, and wrist. Only that instead of one kind of hand, the hands at the end of the external robotic arm can be switched to best support the work needed done.

4.4.4.3. *Airlock*

The Airlock is located right below the main working space of the assembly bay, and right above the upper portion of the docking port. The outermost portion of the airlock floor house over 40 airlocks where individuals or teams of astronauts for EVA can get ready for work outside in the unpressurized environment. More internally it houses restrooms and accommodation for field workers coming back from EVA and for lockers for them to change clothes. The procedure of getting used to pressure differences may pose stress on the body along with inefficiency, so taking some rest is highly recommended. Worker convenience can be pursued by placing indispensable features like the cafeteria and medical office in unpressurized areas.

4.5. **Transportation Complex**

4.5.1. Storage Floor

The storage floor is the top floor of the transportation complex. The outside of the floor serves as rigging to attach resources that are most dangerous such as fuel or other inflammable and explosive materials. The internal storage compartment temporarily store baggage and cargo transported by spacecraft until they are reviewed, confirmed, and redistributed to their destinations.

4.5.2. Parking Floor

The parking floor is a cylindrical row of transport panels right above the hemispherical docking port. Spacecraft for maintenance, those reserved for emergencies, or those that are not planned to be used for some time are moved to this floor. This is efficient for defunct spacecraft because the parking floor is the closest a spacecraft can get to the assembly bay where spacecraft maintenance and repair happen. The unique design of the docking port requires that other spacecraft to be moved for one spacecraft to change position. For this, having reserve spacecraft in the cylindrical parking area out of the docking port saves energy in that empty ports take less energy to move than occupied ports.

4.5.3. Docking Port

4.5.3.1. Docking

The specifics on the operation for the docking port is explained in section 2.8 Docking Port.

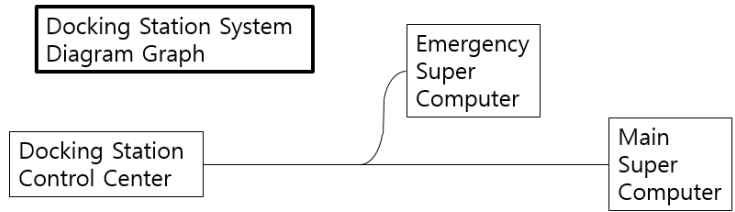

Figure 24. Docking station system's administration software structure

4.5.3.2. Docking Administration and Emergency Countermeasures

The emergency backup system is a fail-safe system equipped to provide for the failure or malfunction of the main docking system. This system also controls the emergency undocking procedures during the evacuation of the settlement.

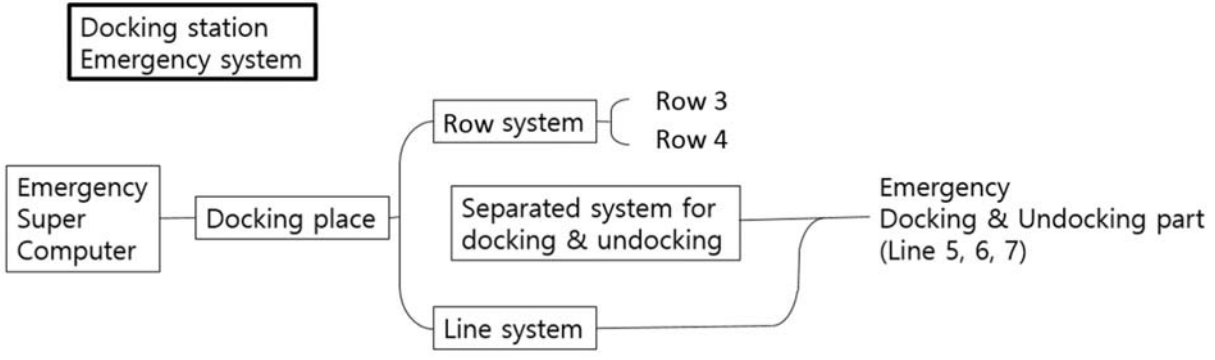

Figure 26. Structure of the emergency administration system of the docking port

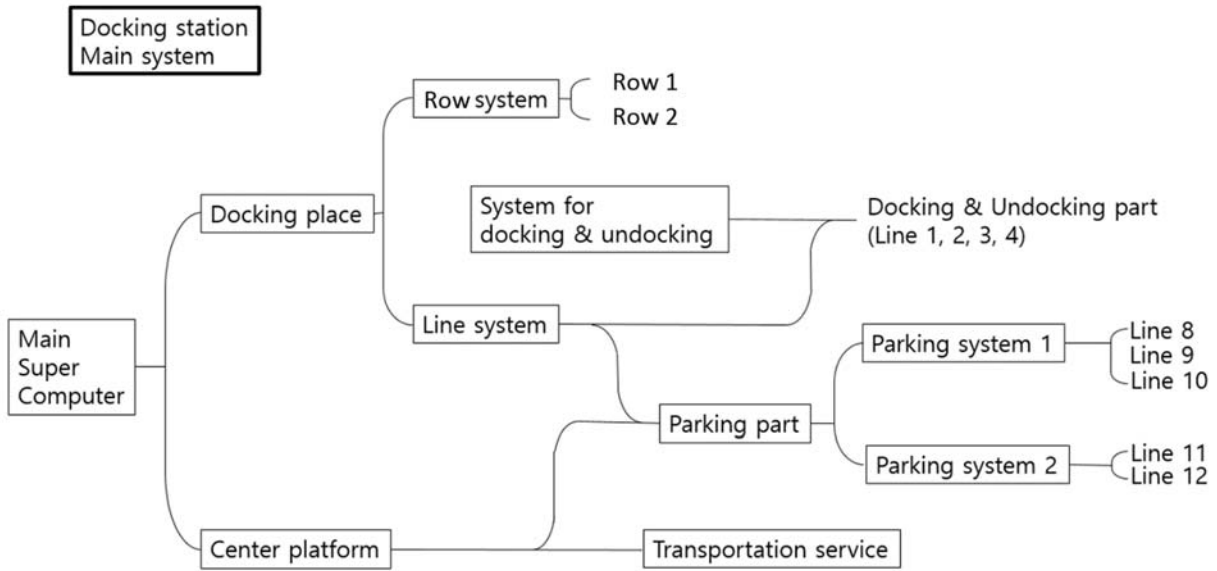
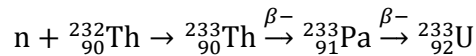

Figure 25. Structure of the main administration system of the docking port

4.5.4. Nuclear Power Plant

Electricity is arguably the most important factor in maintaining Divinity and its functions. Technology, industry and human lives all depend on it. Thus, finding an effective and stable source of generating electricity is very important for all space settlements. Two of the candidates were nuclear fusion and solar power through satellites. However, nuclear fusion proved to be too much of an energy-consuming process, since it virtually required an artificial sun and its container, the tokamak. Solar power was also too low in efficiency and too costly in manufacturing the panels. Also, Divinity won't be able to generate electricity for half of the time when its orbit was behind the Earth's shadow. Compared to these two options, nuclear fission was much less costly and controllable, thus selected as the most probable way for Divinity to get its electricity.

Thorium was chosen as the material for fission, considering its abundance compared to Uranium. The specific type of reactor will be the breeder reactor, which has a breeding ratio bigger than 1 because it makes more fissile material than it consumes. In this case, neutrons from Uranium fission will be used to convert Thorium into fissionable material, in theory extracting nearly all of the energy Thorium has. One example of these procedures can be found below.



The equation above [23] describes a thorium cycle where fuel is formed when 232-Thorium (Th) captures a neutron (n) to become 233-Thorium (Th). This emits an electron and an anti-neutrino in a beta minus decay to become 233-Protactinium (Pa). This then goes through another beta minus decay to become the fuel, 233-Uranium (U).

Nuclear fission will take place inside the docking port, which is hollow. The capacity will be designed to be 700 MW. Water runs in pipes around the port, cooling the heat generated in the process. This hot water will then be sent to residential areas for domestic use, saving the energy to be heated again. This system will be described in detail in section 5.6.2 Water Management.

The lifespan of the reactor, or the length of time expected for safe use, is about 20 years. After that time has passed, or if the reactor is too worn out or potentially dangerous, it will have to be replaced. Replacement of reactor parts will take place by cutting off a section at the docking port and putting it back on after the replacement. Also, the breeder reactor is safer than many other reactors in the sense that will, in theory, only leave behind fission products, which are much less radioactive than traditional methods.

5. Human Factors

5.1. Population Distribution

Below is the ratio of population regarding age, in the year when migration has been completed and population stabilized. The length of the bar signifies the percentage of population the particular age group takes up. There are a few characteristics to this model that gives one insight into the purpose of Divinity.

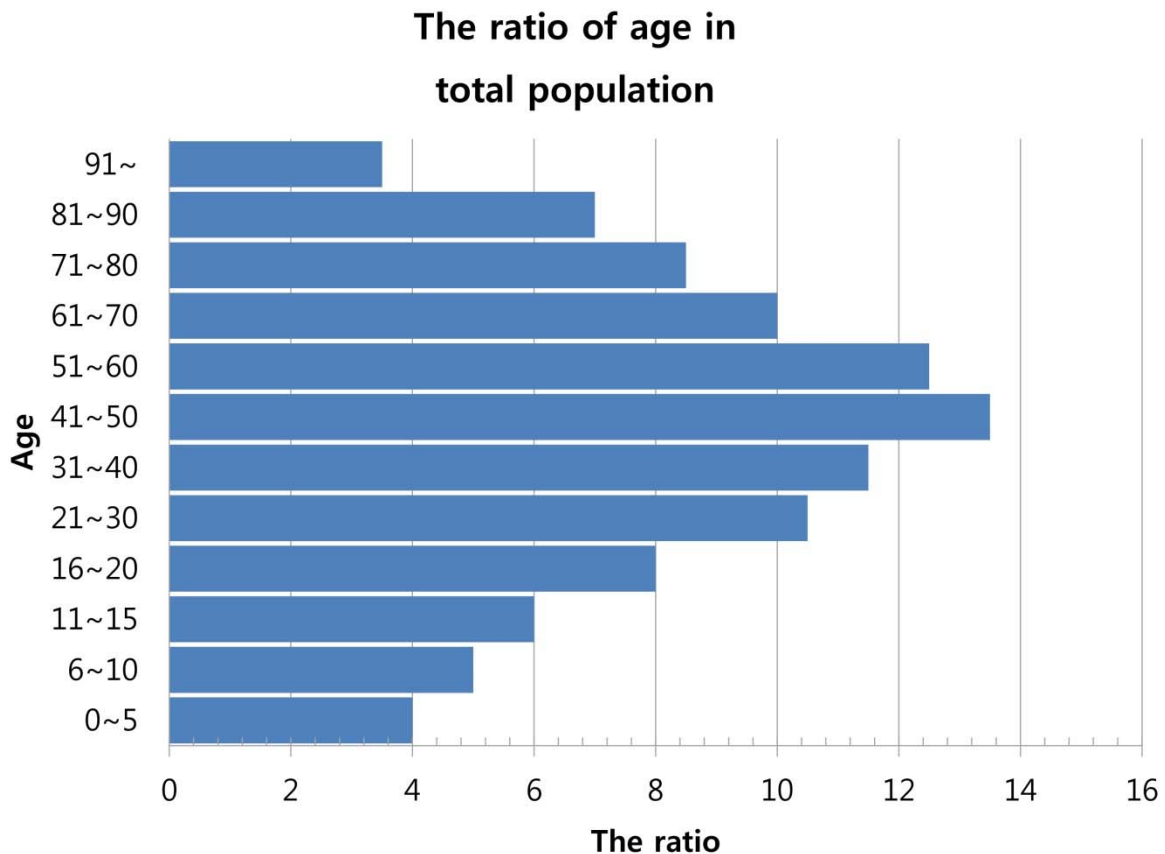

Figure 27. Demographics according to age groups and their relevant percentage in the settlement population

The first characteristic to note is that there are more senior citizens (over 70's) than the youth (30-40's). This might seem unusual at first, seeing that in many conventional societies, it is considered ideal to have a high ratio of younger people to support the old. However, Divinity differs in the way that it serves one of the world's largest science center devoted to research and industry. This center sees an unusually high percentage of experienced professionals, who subsequently are in the age group of 30s to 50s. The other age groups will most likely be students or families of the scientist group.

The ratio of the minors in the entire population is 23 %, married adults 31.5%, and single adults 35%. As mentioned earlier, this is quite different from the conventional ideal, but Divinity's specialty in technology makes possible a working population age from 21 to 80, attending to many factions of

manufacturing and research. The constant moving of population due to individual situations and needs made possible by frequent shuttles will also make for the stability of population.

It is also notable that the occupation of oldest and the youngest population are not negligible compared to the other age groups. For other space settlements, the oldest and youngest have a much smaller ratio due to the fact they are not able to tolerate the high-stress of rocket travel

5.2. Energy

5.2.1. Lighting

Lighting is a significant factor of human environment, with the human biology evolving to match the cycle of the sun and its pattern. In order to make the residents feel at home, a lighting system that resembles that of Earth's is needed. Even psychologically, the mere presence of a sky whose lighting changes with time will help reduce possibilities of claustrophobia. Since there is no practical method to get natural lighting, LED will be used to create the sky of Divinity and illuminate the ceiling. LED is the most fit for all lighting due to its bright light and efficiency.

Specifically, Divinity will make use of the PI-LED¹⁵ technology currently being researched. The recent findings are that it can be used to generate and show distinct differences between cold-white light and warm-white light. It can be expected that as research deepens, the range of natural colors that can be displayed will widen by very much, and eventually resemble natural sunlight to a great degree [24].

Thus, this technology will be used to create the days and nights of Divinity. Having a cycle of day and night just like Earth will greatly help the residents adapt to space environment and get their moods up, since human psychology is closely related to the weather. At day, the LED tiles will color to form a sky blue color with images of clouds floating around peacefully, and they will darken as time goes by to form a night and after some time turn off completely. If there is deficiency in some parts of the tile, night would be the right time to repair.

5.2.2. Electricity

Electricity will be supplied by a nuclear reactor within the docking port, transferred in the form of alternating currents (AC) with initial voltage being 22kV. It is raised to 765kV right after generation to avoid power loss. Then it is supplied to the industrial complex and the assembly yard via wires embedded in the walls of the central hub. There, the voltage is lowered to 440V for industrial use. As energy supply to the industrial complex and assembly yard directly influences the success of operations, stability in electricity transfer is most important. The nearness between the generator and the industrial area also helps to maintain high voltage and which maintains power loss in energy transfer at minimum.

The electricity for the 3 sectors in the microgravity complex will be supplied through another line going through the generator and the control deck. For the residential area, electricity will move through the spokes into residential facilities and individual homes. When in the residential area, a converter will lower the voltage to 220V for domestic use. Since all 6 spokes are connected to the power source

¹⁵ PI-LED technology is a hybrid module of white light LED module, RGB (Red, Green, Blue) module, and phosphor-based LED sources. The combination of RGB LEDs and phosphor in a high amount will lead to light emissions with optimized efficiency (green). Controlling the other two colors (red and blue) will enable efficient emissions of infinitely many varieties of white. The point is meeting the optimized region for each phosphor.

with direct, separate lines, there should be less power loss and greater stability than transferring all power in one line and then branching them off.

In all of these procedures, diverse voltages of electricity are supplied in large amounts to maximize efficiency. As such, conversion systems will be established at all the points of supply and receipt for the smooth flow of electricity without delay.

5.3. Residential Community

5.3.1. Amenities and Facilities

In the residential community of Divinity, there will be establishments for the general welfare of residents working or resting, along with systems to support those establishments. For the convenience of all residents, Divinity will provide a stable social system and a way to move efficiently inside the residential torus. Food, medicine and environment are described in detail at other sections. To support leisure time concerning the happiness of individual lives, Divinity will be equipped with amenities that will keep the residents occupied with satisfaction.

5.3.1.1. Administration

The most important factor in a stable human life is a solid social structure. To begin with, the overall management such as expenses will be taken care of by the administration center. The center will be open to any suggestions for better welfare or efficiency. Laws are expected to be modified from Earth in accordance with Divinity society by a democratic process, and the police and court will help the execution of those laws. The security regarding personal areas and privacy will not only be maintained by personalized passwords but with one expert team per unit.

5.3.1.2. In-Torus transportation

The most popular way of transportation in the torus is the skytram. The skytram is a modular train attached to a series of rails to the “ceiling” of the torus that serves the purpose of a means of transport and an attraction for tourists. Two sets of rails that goes in opposite directions are lined to the ceiling, with stations being constructed at the point where each spoke connects to the torus. To ride the skytram one must ride an elevator up to the SkyStation, which also serves as the depot and station for passengers and cargo from and to the non-gravitational parts.

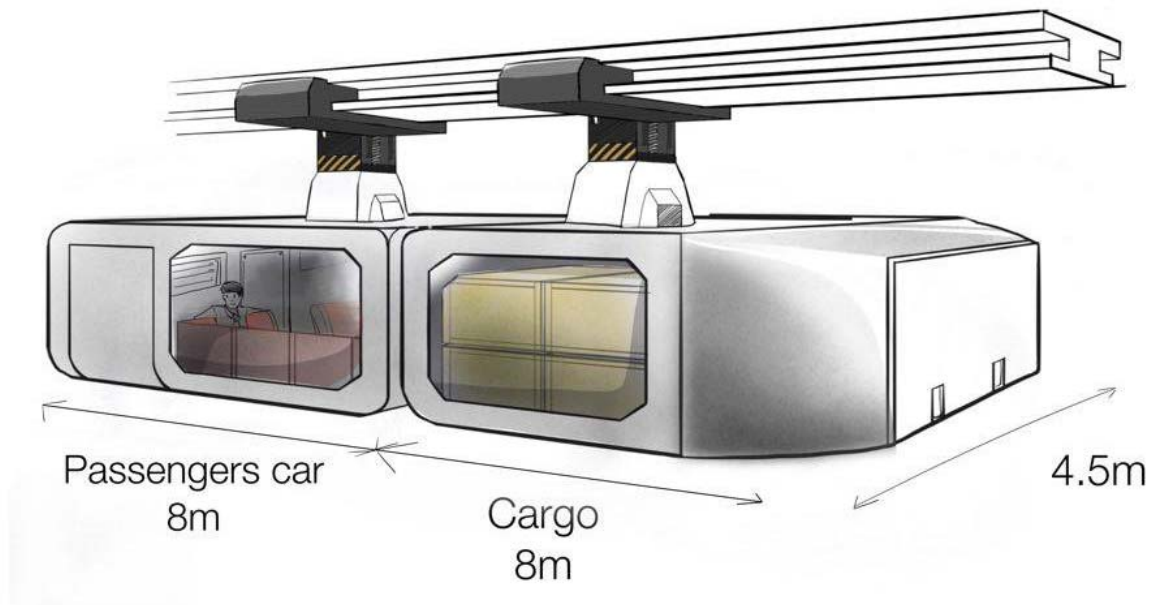

Figure 28. An illustration of Skytram. Only one rail is shown with both the cargo and passengers shuttle

5.3.1.3. Shopping and Consumer Support

The aim of social amenities is to help residents feel stable or pleasant at times other than work. It should stick to the needs and wants of the residents. There will naturally be shops and services like the movie theater to make revenue in the shopping center, but this section will mention amenities and systems that need to be provided by the overall administration.

Convenience stores with high accessibility and e-book libraries will obviously make residential life smooth, but Divinity will go one step further. It will provide education for those who want to learn a hobby or an instrument, and connect a counselor to those who seek mental comfort and problem solving.

5.3.1.4. Life Quality

Divinity will constantly seek ways to enhance residential life in every aspect possible. For example, devices to help people adjust to rotation will greatly enhance the comfort during the first levels of settlement. Also, a work environment designed to respect the different propensities of work-rest patterns is likely to increase work effectiveness. Stress-relieving spa programs and nature treatments in the park will also be prepared.

5.3.2. Healthcare and Medication

Divinity collects taxes from its residents. The money is not only used to repair and maintain Divinity but to provide social security facilities and health insurance. The space settlement settings are in some ways similar to Earth and while it is true that designers should try as hard as possible to make the areas of human life emulate Earth, there are some inevitable factors. These factors may create unprecedented situations, adding to the need for a good medical system.

One main factor is gravity. Since the majority of Divinity residents will work in industrial factions with micro-g near the center nearly every day, sicknesses regarding the stress on bones and muscles,

the abrupt change in forces acting on the body. Another factor is that Divinity is a small society and infectious diseases may lead to disastrous results. To appropriately cope with possible situations, a system of fast diagnosis, prescription, constant analysis and research will be needed.

5.3.2.1. General Healthcare

The first diagnosis will take place in local clinics. In the clinic, the doctors will decide whether clinic treatment will be sufficient for the patient. If not, the patient will be transferred to the hospital. The clinic will be not too big, supplied with simple medicines and treatments for specialized factions. Examples of factions would be ENT, dentistry, obstetrics with postpartum centers, and the ophthalmological center. The hospital is much bigger and equipped with teams of doctors and devices of every faction. Surgeries, if done on Divinity, will take place at the hospital.

5.3.2.2. Psychological Health

The psychological clinic will help the patients who are psychologically broken down, with medicine and counseling. The role of the psychological clinic will be even more emphasized on Divinity than on Earth, due to the fact that there is a lot of adapting to do including the absolutely new physical environment and meeting completely new people. Examples of the needed care are depression, claustrophobia and serious nostalgia.

5.3.2.3. Infectious Diseases

If a patient is diagnosed with an infectious disease at the clinic, the degree of the disease will decide if s/he will be isolated. When the disease is low in its degree of infection, the patient will be strongly recommended to rest in home and not come out if possible. In cases where the virus has never been experienced, highly infectious or deadly will have the patient immediately removed to a completely isolated place.

As an enclosed society, Divinity is very vulnerable to plague. The possibility of unforeseen, new infections or viruses due to radiation or differences in atmosphere makes it even more so. If a new infection was found with no cure, it is possible that an apocalyptic scenario may take place. Thus, Divinity hospitals will have to isolate those patients completely in biology labs or isolation chambers before beginning to treat the patient. Even more important is the prediction and making of a solution before this kind of situation takes place. Along with gravity-induced sicknesses, possibilities of new infections need to be studied thoroughly, beginning at the preparation stages and developing with accumulated data.

5.3.2.4. Surgery

In the case where surgery is needed, the doctors and the patient will decide the place where the operation will take place: Earth or Divinity. On one hand, the space environments may have a physiological and psychological effect on the rate of recovery of the patient, especially for those who have left their families behind on earth. On the other, the trip back and forth between Earth and Divinity may have a negative effect on the bodily state. Thus, decision should be shrewdly made.

5.3.2.5. Health Checks

Divinity provides regular health checks for its residents. Like on Earth, health checks will be used to find chronic diseases or to diagnose cancer as early as possible. Since health is a very important factor related to living in space, the health check may serve as a finder for those who need to go back to Earth.

As mentioned in Food and Agriculture, there is no fixed limit or mean to force the food consumption of residents. Thus, in some cases, there may be residents who get obese or be in a state of serious nutrient unbalance. Also, the effect of regular gravity changes are quite in the dark, so they need to be observed too.

5.4. Food and Agriculture

5.4.1. Nutrients

Table 2. Properties of nutrients consumed by residents on Divinity. Type, consumption per day per person, consumption per year, and source for nutrients are noted.

Nutrient	type	Consumption / day / person	Consumption / year	Consumed from
Carbohydrate	Carbohydrate	315 g	> 1150 tons	Grains and cereal
Amino acid	Essential	> 50 g	> 182.5 tons	Meat and beans
	Non-essential			Meat
Fatty acid	Essential	50 g	182.5 tons	Vegetable oil
	Non-essential			Animal oil
Vitamins	B to U (excluding A and D)	unlimited	Unlimited	Supplied with water and fruits
	A	700 - 4000 micrograms	Maximum 14600 g	Greenish-yellow vegetables Carrots, pimento, spinach
	D	> 5 micrograms	unlimited	Supplied through lighting
Mineral	Water	10 g	36.5 tons	General food
Water	Water	> 10 liters	> 0.125 tons	Water supply

In order for any human to keep living, the five nutrients and water as mentioned above should always be supplied. If the food is cut off, one's survival is threatened and if it is not supplied to a needed degree, a health degradation is to be expected. These situations will obviously have detrimental effects on the lives and work efficiency of the residents, and thus it is absolutely necessary that the supply of nutrients be continuous and stable.

In a huge space city like divinity, it is almost impossible to provide the exact amount of nutrients that is the most prime for health. It would not be viable to feed residents only what is required or limit their choice of food, hence the connection to freedom and happiness. Thus, the most prudent way to efficiently supply needed nutrients would be to control the amount and types of food that are carried into Divinity, and constantly remind and educate the residents of the importance of a balanced diet.

Owing to Divinity's unique characteristics, the flow of food into Divinity will be quite easy; it is close to Earth, and there are many shuttles pre-prepared for humans and cargo shipping. Therefore, it is safe to suppose that there will be no upper limit to food that can be transferred from Earth to Divinity, and

that whatever food that has limits to being grown on Divinity will be stably shipped from Earth. Food-related health problems will be dealt with in section 5.3.2 Healthcare and Medication.

The following is the way how each nutrient works with its unique function in human bodies.

5.4.1.1. Carbohydrate

Carbohydrate is converted into sugar during digestion to be used for all human activity. It is a main source of fuel for cellular respiration, engaging in breathing to keeping the human body warm. If its intake exceeds its use, carbohydrate will be stored in the human body in the form of fat. 4 kcal/g

5.4.1.2. Amino Acid

Amino acid is the basic unit of protein that makes up the body. There are 22 kinds of amino acids, and among them 8 has to be acquired from the outside because it cannot be synthesized inside the human body. It is usually supplied through meat but can be supplied through vegetable protein. Beans are a prominent source of vegetable protein, and they can be a sufficient source without much change in the amount of consumption of current Earth-living humans. 4 kcal/g

5.4.1.3. Fatty Acid

Like amino acids, there are also kinds of fatty acids that cannot be synthesized inside our bodies. If humans are deficient in those kinds of fatty acids, they may experience problems like growth stagnation, disease in circulating system, and eyesight deterioration. The three essential fatty acids can be supplemented with vegetable oil, nuts, and blue fish. 9 kcal/g

5.4.1.4. Vitamins

Vitamins are like hormones in a way that they control bodily functions with small amounts, but differ in the way that they cannot be synthesized inside the body. Vitamins are divided into water-soluble vitamins like vitamins B, C and oil-soluble vitamins including A, D. On Divinity, water-soluble vitamins are supplied in water. Naturally, all residents will get access to the needed amount of water-soluble vitamins. If one drinks more than 3 liters of water per day, s/he would not need to have any other source of water-soluble vitamins. For oil-soluble vitamins A and D, A will be supplied through food and D will be synthesized with the aid of artificial lighting in Divinity. Vitamin D synthesis regarding light will be dealt with depth in section 5.3.2 Healthcare and Medication.

5.4.1.5. Minerals

Minerals are needed in diverse parts of the human body, ranging from hard, stiff organs like teeth and bone to soft organs like the skin and intestines. The required amount is included in everyday food so it does not need to be supplied in a special method.

5.5. Entertainment and Sports

5.5.1. Microgravity Exhibitions

5.5.1.1. Microgravity Art Gallery

The microgravity art gallery will house various 3D art that cannot be made or experienced in a gravitational environment. The exhibitions will be routinely changed, providing additional incentives for new tourists to arrive, existing tourists to stay longer, and experienced dwellers to visit the settlement again. First and foremost, the exhibitions will provide a source of additional revenue to the settlement, as artists will pay to have their artworks exhibited, and tourists to see them. Yet secondly

the 3D art gallery will open up a new genre of art. Already the genre of 3D art in the form of sculptures, mobiles and 3D printed objects is of great acclaim on Earth. While sub-genres such as mobiles utilize gravity to its virtues, the prospect of its vacancy will open a whole new world of 3D art where sculptures do not have to be attached to each other, mobiles will have greater degrees of freedom than the z-axis, and 3D printed objects can explore fragile shapes unsupportable on Earth. Not only will the microgravity art gallery provide a new way of expression for existing 3D art, it will also be able to expand a new dimension to existing 2D art. Paint pendulums are a form of 2D art where paint buckets with holes driven through their bottoms are hung from ceilings, the splatter of ink on a two-dimensional canvas forming a piece of art. A three-dimensional counterpart of the paint pendulum will be a paint extinguisher where a fire extinguisher is let loose in microgravity, but with instant-freezing ink in the place of extinguishing foams. Such exhibitions will be allowed proper viewing only in a microgravity environment yet imaginative artists¹⁶ could think of ways to export such artworks to Earth by freezing such works in special glass. Artists proficient enough to pioneer a new world in 3D art will garner great acclaim and fame, as well as a getting his or her name in the textbook of art history.

¹⁶ Shown in the figure below is the American interdisciplinary artist Frank Pietronigro. Frank has developed the art genre “drift paintings”, a form of space art in which the artist floats weightlessly in zero-gravity while painting within a three-dimensional environment. On April 4, 1988, Frank took off from NASA’s Johnson Space Center aboard the KC-135 “the Vomit Comet”, creating the world’s first drift painting. In moments of weightless during the flight, Frank squeezed paint out of frosting bags and let it float into the air and make randomly make contact with the sheets of clear plastic that served both as his enclosing compartment and as his canvas. [34] [35]



Figure 29. Documentation of Research Project Number 33: Investigating the Creative Process in a Microgravity Environment, 1988. Photo courtesy of the artist and NASA.

5.5.1.2. Microgravity Museum

Microgravity museum will house the finer experiments done in microgravity. Even to this day scientists above the ISS are conducting experiments on physical properties, animal biology and chemical wonders that are seen with much interest on Earth. The microgravity museum will reconstruct



Figure 30. Astronauts on the ISS dissolved an effervescent tablet in a floating ball of water, dyed with food coloring. Photo credit: NASA Johnson Space Center [38]

important or visually appealing experiments¹⁷ that will provide huge educational incentives for wealthy private schools on Earth to plan school trips to the settlement.

5.5.2. Microgravity Performances

5.5.2.1. Execution of Bodily Movement

Theatricals and circus on Earth show amazing performances even when they are bound to Earthward. The possibilities of the human body and dramatic elements in microgravity is limited only by imagination. While some might say that performances in microgravity will actually be easier than on Earth, the amount of spins and moves that a performer can execute in microgravity will tax heavily in the ability of the performer to coordinate himself or herself, and to control the body even in high states of acceleration. Group performances where performers are linked together, throw each other in different directions in different orientation will be incredibly more difficult just to view and comprehend, let alone choreograph and execute such movements, given the new coordinate of freedom. All these provide reason why we could expect the best performances in microgravity, and expect nothing less than the best performers to be able to handle such complexities.

5.5.2.2. Appliance of Theatrical Components

The human movement is not all in microgravity performances as dramatic components, jigs, and special effects will be taken to a whole new level in microgravity. Simple mechanical arms that normally support actors to jump and move around can be used to rotate performers mid-air, hoist them from one end of the room to the other, and independently work to shoot recordings of the show. But components need not stop in mechanical structures, as even for shows on Earth fluids and gases work in combination with lighting to create spectacular experiences. As fluid mechanics in the absence of gravity becomes easier to predict and its effects more lasting, use of winds and mists in the microgravity theatre is highly recommended.

5.5.2.3. The Microgravity Viewing Experience

Lastly, the whole structure and the viewing experience of shows will change. On Earth, stages would be in front, with seats going back and above to see the stage. The stage is rarely situated in places other than the front as jigs, platforms, lights all have to be attached somewhere. In microgravity, lightings and platforms could be constructed right in center of the theatre, with viewing seats enclosing the semi-spherical arena. With each seat offering different orientation and exposure to the show, viewers will have great incentive to see the same show multiple times to enjoy the show in its full spectrum.

5.5.3. Microgravity, Low-g Sports

Microgravity and low-g environment allows for different kinds of sports to be played. The Divinity settlement comes with various sports facilities that provide space for stunning new sports to be experimented and played. In some cases, the sports played is only a variation or a new adaptation of a sport that is already existent. In other cases, the sports played is only playable and viewable in the Divinity settlement, attracting players and audience alike to the settlement for its unique experiences.

¹⁷ In October 2014 NASA delivered high-definition, 3-D footage of astronauts living and working on the International Space Station to the Internet, posting video of astronauts exploring water tension in microgravity. The astronauts experimented with water, antacid, and food coloring to create incredible, fizzing aqueous spheres in the microgravity environment [36] [37]

This section will look into some possibilities of such sports, and how the resources will be allocated if such sports were to be actually played.

5.5.3.1. *Quidditch*

Quidditch is a kind of sport that has become famous by the book series “Harry Potter” by J. K. Rowling. It is a kind of sport played among wizards and witches, where players ride flying brooms to conduct various aerial maneuvers while passing balls. As Quidditch is essentially a kind of sport that is available only in the imaginary, magical world, exact execution of the sport in real life is virtually impossible (for one thing, there are no magical “Bludgers” that try to kill or seriously injure players.) Yet even with this impossibility Quidditch has become a recognized sport on Earth, with at least 20 quidditch-playing organizations and nations participating from over six continents, governed by the International Quidditch Association [25].

Figure 31. Quidditch as seen in the movie series of Harry Potter. Daniel Radcliffe as Harry Potter is sitting on his broomstick at a Quidditch match, with the Hogwarts Quidditch field at the background. The Golden Snitch can be seen on the top right corner. Photo credit: Warner Bros.

Quidditch on Earth takes a form where two teams, each with seven members, compete against each other for higher points until the end of the game. Players play on broomsticks, with the players divided into three Chasers, one Keeper, two Beaters, and one Seeker. The most used method of scoring is by throwing or kicking the Quaffle (a volleyball is usually used for the role) into one of the three hoops of the opposing team, with each goal scoring 10 points. The Keeper guards the hoops from opposing chasers while Chasers score goals by throwing the Quaffle into the hoops. Beaters use a different ball called Bludgers to disrupt other players by throwing them to hit players of the opposing team. The most fascinating element of Quidditch which sets it apart from all other Earth sports (or Muggle sports, in Harry Potter jargon) is the presence of a Snitch. The Golden Snitch in the Harry Potter universe is a magical orb with wings which the Snitch uses to fly around the arena. The Snitch belongs to neither team, and the team that catches the Snitch acquires 150 points, at which point the game is ended. In the real-life adaptation of Quidditch, the Snitch is replaced with a tennis ball tied to the back of a

“Snitch runner” who runs around the pitch trying to avoid getting caught. While the fact that only Seekers are allowed to catch the Snitch, the score is reduced from 150 points to 30 points in the real-life adaptation [26].

Figure 32. Starting of the game at the US Quidditch World Cup 8, April 11, 2015, Manchester Meadows, South Carolina. Photo by Michael E Mason Photography, US Quidditch Press Kit October 2015 [40].

Due to Quidditch’s magical characteristics, the full potential of Quidditch is not explored, with the game spiced up only by the players’ and viewers’ imagination. With microgravity and technology, the authors of Divinity see that the full potential, and fun, of Quidditch may be released. Where magical brooms were substituted with players’ legs and a “dead” broom hanging between the thighs, Divinity’s Quidditch will have brooms that operate similar to jet packs. Players will have control over maneuvering the broom in the intended direction with adjustment of flaps while its speed can be governed by the use of throttle. While a variation of the “broom” may be developed for transport within microgravity environment, the brooms licensed to be used in the sport will intentionally have some safety features disabled so that it will also see players’ ability to stay on the broom (or, for novice players, not to *fall off* the broom.) The Snitch will be replaced with a small drone that a neutral player will remotely control, rather than have it hanging behind his or her back. Such adaptation will make the game much more similar to the Quidditch described in the Harry Potter universe, where the points scored by grabbing the Snitch may be re-increased to 150 points.

Seeing the continued growth in interest of Harry Potter book and movie series, and consequently of the game therein, Quidditch, the authors of project Divinity observes a huge market that will be highly beneficial to the economy and fame of Divinity. In so, the authors of Divinity have developed a sports

stadium that has a Quidditch arena suited for its fame. The stadium takes up a whole quarter of the middle part of the Microgravity Complex. The stadium is divided into three parts, the Quidditch main ground, the Quidditch practice ground, and a reserve space that will be used to experiment other kinds of microgravity sports.

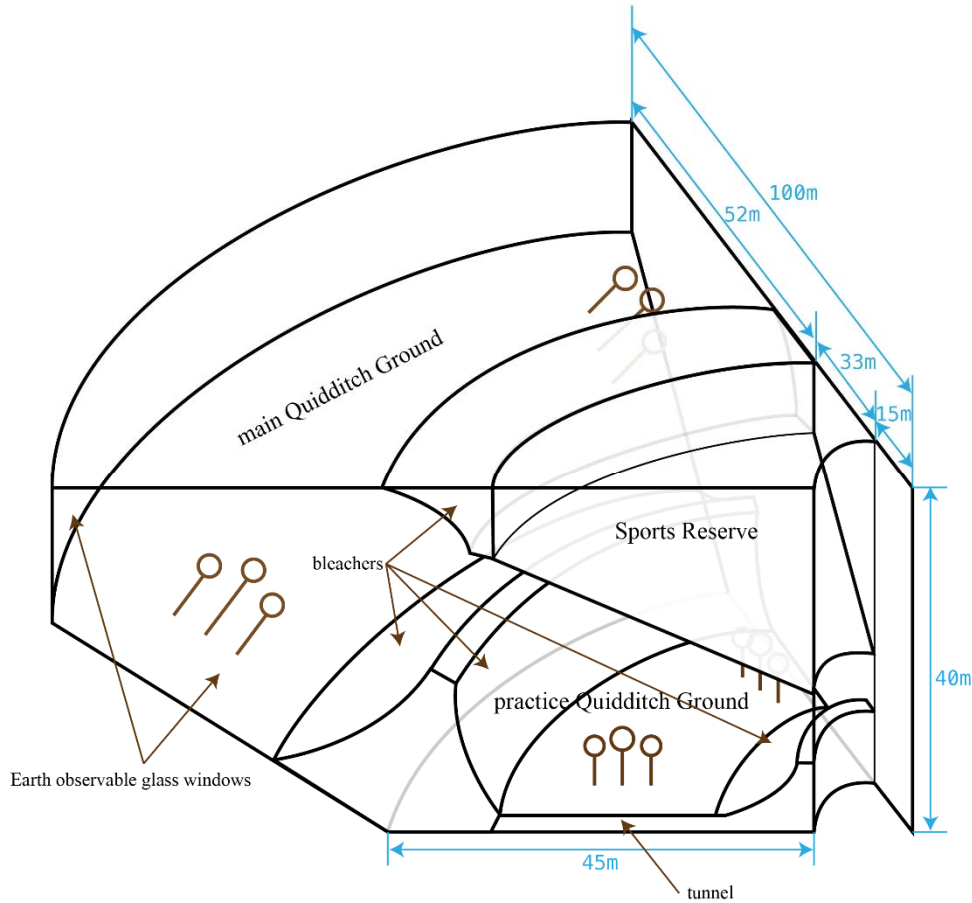

Figure 33. Sports Quarter of the Microgravity Complex. The main Quidditch stadium, practice Quidditch stadium, and sports reserve space are shown. A tunnel is used to get to the main Quidditch stadium from the central hub.

The main Quidditch ground spans the full quarter length of the lower inclined portion of the Microgravity Complex. As the games played will be broadcast to a wide audience both on and off Earth, the designers of Divinity saw this as a great opportunity to have Quidditch played against a rotating Earth backdrop. Where there are paying viewers to see either the rotating Earth or the Quidditch match, an opportunity to see both on the same camera will draw an audience that combines both kinds of viewers. At the opposite side to the Quidditch playing airspace will be two sets of bleachers, one on “down”, or Earthbound direction, and the other on the “up” or skyward direction. As the complex is kept in microgravity state, either direction is equally appealing. Among each bleacher are four towers which, in the Harry Potter universe, is a place where the most dynamic events between the Snitch and the Seekers happen. Following that description, the towers extend into the allowed airspace, with the Snitch controller room situated in either one of the eight towers. While the Quidditch

ground in Divinity settlement is curved in a circular manner, its length along the approximate mean is 137.5 meters, close to the 150 m as described in the Harry Potter universe¹⁸.

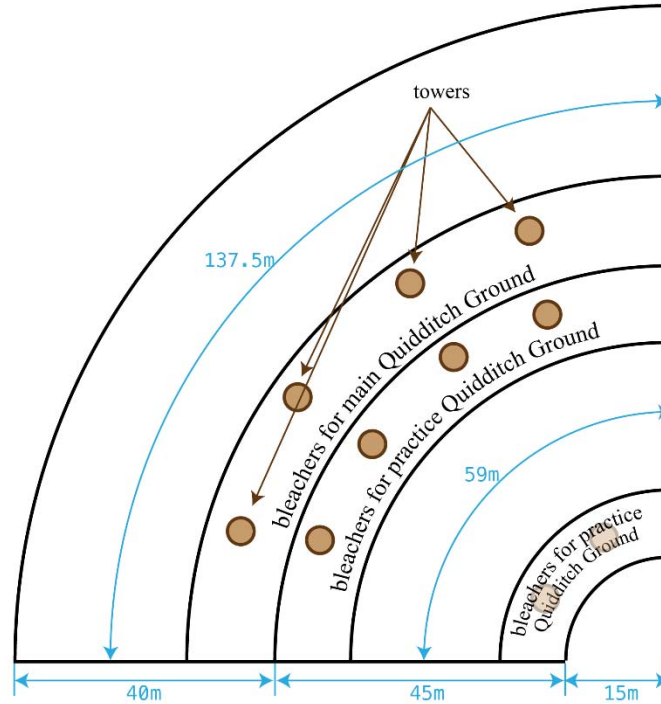

Figure 34. Area distribution of the Sports Quarter as seen from above.

The Quidditch practice ground is smaller than the main Quidditch ground, yet located right next to the main Quidditch ground. It has an approximate mean length of 59 meters, with two sets of bleacher on the “down” direction. The bleacher nearer to the Central Hub is smaller, having two towers while the bleacher neighboring the main Quidditch ground has four towers. The Quidditch practice ground is used by novice players or amateurs while the main Quidditch ground is reserved for professional players. As the Divinity space settlement will likely be the only place where microgravity Quidditch can be played and practiced, it was deemed essential that the needs of both professional players and Quidditch enthusiasts be satisfied, resulting in the construction of two grounds.

5.5.3.2. Other Microgravity Sports

A space of approximately 32,000 cubic meters (33 meters radially extended from the central hub, 20 meters in height, quarter of the floor) is reserved for experimenting with other forms of microgravity sport and its plays. The reserve arena will be made adaptable to various conditions, with quick installation and dismantling of sports equipment. Possible sports that can be played in the reserve arena will be microgravity soccer and lacrosse. Soccer and lacrosse are two sports that can be adapted for the

¹⁸ Quidditch as described in the book *Quidditch Through the Ages*, Scholastic Publishers, J. K. Rowling, 2010, happens in an oval pitch 500 feet (150 meters) long and 180 feet (55 m) wide. Quidditch as adapted to play on Earth is a similarly oval ground 60 yards (54.864 meters) long and 36 yards (32.918 meters) wide [39].

microgravity environment by using small jet packs to control the players' movements. Other than that, the goals of the games are the same: to get the ball into the Goal by kicking and using lacrosse sticks, respectively. Since there is no gravity, different skills to win the game will develop, making the games much more interesting.

5.6. Life Support

5.6.1. Atmosphere

Atmosphere is a mandatory feature for a space settlement. People cannot live without breathing, nor can they live in vacuum without the pressure of 1 atm pressing on their skins. Since the activities that take place in Divinity require similar conditions to Earth, Earth and Divinity will have the same composite of gases for atmosphere. To specify, 21% of atmosphere will be oxygen and 79% nitrogen. Due to the fact that Divinity does not use any fossil fuels to create excess carbon dioxide, the amount of carbon dioxide created from human breath will be balanced by the amount that plants (crops, rooftop gardens) need for photosynthesis. Possible unbalances will be taken care of by the air cleaning system.

5.6.2. Water Management

Water is as crucial as atmosphere for humans in space. Water stays in the liquid state only in the Goldilocks Zone of the solar system, and only exists on few meteors and comets. Divinity is also another place where the value of water is extremely high.

Divinity, utilizing its proximity to Earth, will carry water by space shuttles from Earth in the early stages. Then the water is to be reused as many times as possible by the use of membrane filters and other purification systems. Constant research and analysis of the Divinity environment will help to develop even more efficient methods of purification. Through these systems, 99% of supplied water will be reused. The 1% that cannot be reused is the water exposed to and contaminated by the atomic fission port to cool the heat.

Hot water will be supplied by the heat of atomic fission. By this method, Divinity can reuse the otherwise wasted heat of the system and avoid using more energy to heat cold water in individual homes. This will be very cost-efficient.

As mentioned in Food and Agriculture, Divinity provides water-soluble vitamins to its residents by dissolving them into drinking water. This procedure, including balancing, is done between the tank that contains purified water and the direct supply pump. The water is balanced to meet 40% of required vitamin per day in each liter. Therefore, a resident drinking 2.5L of Divinity water would not have to eat any other supply of vitamin.

5.6.3. Thermal Environment

5.6.3.1. Thermal Comfort

Thermal comfort is the condition of mind that express satisfaction within the thermal environment, and can be measured by subjective evaluation. Thermal comfort is influenced by metabolic rate, clothing insulation, air temperature, mean radiant temperature, air speed, and relative humidity, as well as psychological parameters. Thermal comfort is of great interest especially to designers of closed spaces, and its importance in the Divinity space settlement, itself a closed environment, cannot be overemphasized. Project Divinity adopts the existing Predicted Mean Vote (PMV) model to calculate the goal targeted thermal parameters inside the settlement.

Although it is simple and easier to manipulate an environment with fixed temperature and humidity, fixing an ideal does not necessary guarantee satisfaction for residents. According to ASHRAE¹⁹ Standard 55-2013²⁰, the factors regarding thermal comfort are so intertwined that they cannot be thought of without another. For example, a 27°C day would be bearable for the average human when the humidity is 0% but agonizing at 100%. Therefore, Divinity will combine ASHRAE modeling and additional research at Divinity to acquire the highest percentage of satisfied population. One method this system could initiate would be analyzing the characteristics of cities on Earth that are currently appraised to be blessed with good weather. For example, Miami, Florida has the average daily temperature of 19.9°C and relative humidity ranging approximately from 59% to 87% in January and 27.7 °C with 64% to 83%.

¹⁹ American Society of Heating, Refrigerating, and Air-Conditioning Engineers

²⁰ Also known as ANSI/ASHAAE Standard 55, its full name is the *Thermal Environmental Conditions for Human Occupancy*. It is a standard that provides minimum requirements for acceptable indoor environments, establishing the ranges of indoor environmental conditions that provides thermal comfort for its occupants. Standard 55-2013 is the most recent version of the standard, published in 2013. [45] ANSI is the abbreviation for the American National Standards Committee.

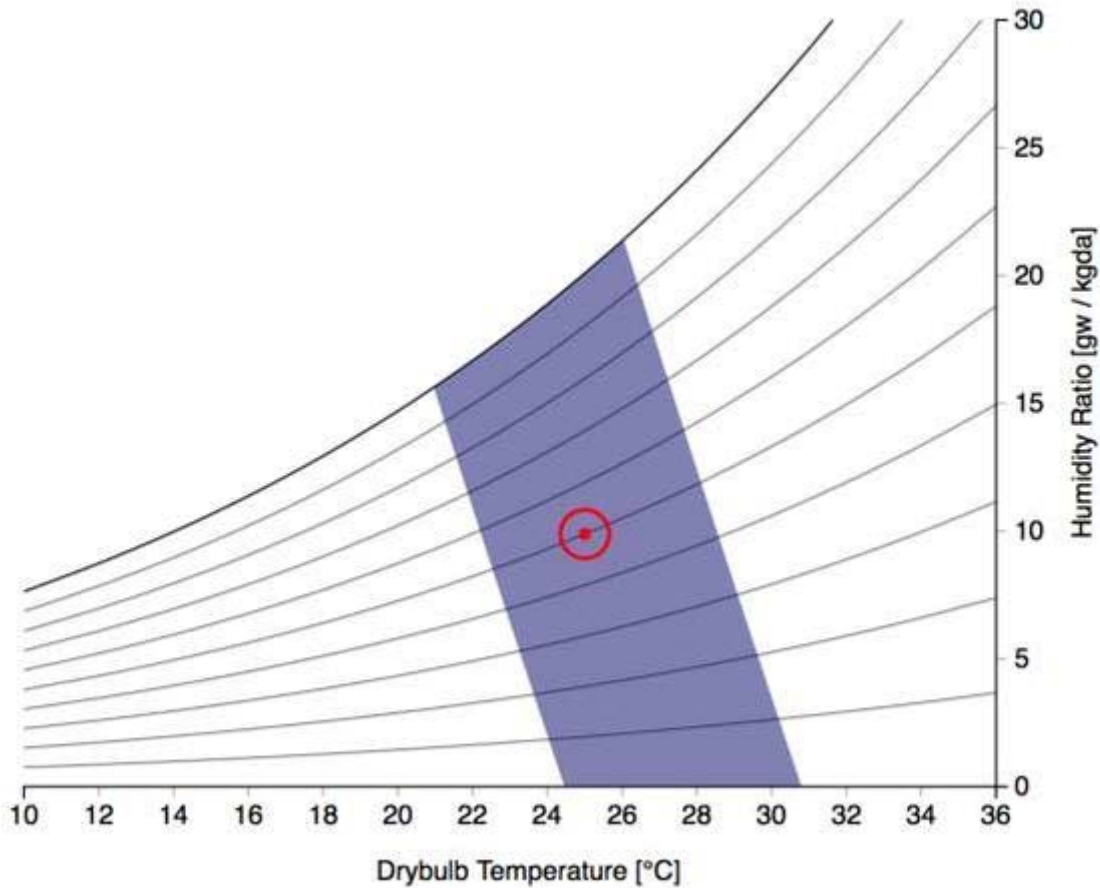

Figure 35. A psychrometric chart representing the acceptable combination of air temperature and humidity values according to the ASHRAE 55-2010 standard. The zone colored in blue represents 90% acceptability, or conditions between -0.5 and +0.5 PMV. [46]

5.6.3.2. Temperature

The personal differences regarding gender, age and health will be covered by local clothes design guides to heat loss. Places closest to those who need sensitive care, such as the nursery, will be supervised with the utmost care by experts.

Personal areas will be able to be controlled by the residents' preference with heaters and air conditioners. Temperatures which have the most possibility of personalized thermal comfort will be suggested.

The temperature of outdoor air will be controlled with the same system that supplies new air. The manipulation of temperature will take place in the tubes that the air goes through just before being released to the residential area. Since air is being circulated constantly, the temperature is expected to stay at similar levels.

5.6.3.3. Humidity

Indoors, the ideal humidity varies with temperature and many personal factors that greatly leverages on personal preferences and needs. So, a system will maintain the ideal humidity for a temperature selected by its occupant. If a resident need higher or lower levels of humidity than ideal, they may change the percentages within some degree.

Outdoors, literature agrees that outdoor humidity that people find most comfortable is 45%, the targeted goal of the Divinity settlement. This level will be kept by sprinklers on rooftop gardens, vapor outgassed by plants, and the water that is contained in people's breaths. While there is air circulation inside the settlement, humidity will be marginally higher in parks and rooftop gardens because of increased flora, and slightly lower in more urbanized environments with higher population densities.

5.7. Contingency Plans

Although Divinity is designed to be sturdy to problems from the first plan, there may be emergency situations where it is absolutely necessary to accept the losses and minimize them to the best possible degree.

5.7.1. Space Debris

To protect Divinity from more than 500,000 pieces of space junk floating around the Earth orbit at high velocities, predicting and maneuvering may not always be enough. Therefore, a debris shield will be installed outside the residential torus. By the shield, the residential torus and the central section (except for the top and the bottom parts) will be protected from direct impact by space debris. This shield will be made of lunar regolith, so it will also function as an effective shield against (mostly solar) radiation.

5.7.2. General

There is also a need for preparation to dangers from inside Divinity, such as fire, electricity cut-off, air leak, and terror. For any emergency situation that requires the abandonment of a part of Divinity, the residential area is divided into 6 independent sectors. Apart from the fact that the central hub supplies materials to all of them, they operate in completely separate terms. This enables the abandonment of a sector to avoid further damage in times of utmost emergencies. If a part is broken or needs to be replaced in a sector, the adjacent sector may help to provide supplies rapidly.

5.7.3. Fire

In case of fire, sensors will immediately react to smoke or the sudden increase of temperature. The LED ceilings, connected by the ubiquitous system, will also change its color to notify the residents of danger. This way, residents will be able to see the location of the fire and evacuate themselves away from the burning sector. The local sprinklers will go off automatically, and alarms will be sent to the closest fire department for firefighters.

5.7.4. Air Leak

Regular check-ups are to be done concerning air leaks. However, there still may be unprecedented air leaks. In those cases, the first procedure would be identifying the specific place of the leak by sensors that detect change in air flow. In the case where there is a leak in the residential areas, the specific section will be identified and temporarily be shut off from other sections. The residents will wear personal space suits until the leak is repaired. If a leak occurs at the industrial area, evacuation and the use of emergency space suits will go together to guarantee the safety of all. In very rapid leaks where the aperture is quite big, the use of shuttles as a temporary haven.

5.7.5. Emergency evacuation

In cases where the cylinders of Divinity are broken, or more than one spoke is broken of six spokes, an extreme emergency situation may befall Divinity. In those cases, residents should leave the

settlement with the aid of pre-selected and trained emergency managers of each sector or workplace. The managers will make sure of the 100% evacuation of residents, the saving of important documents, salvaging of property and other situations related to evacuation. One of the most important things the managers should check is electricity with the energy faction, since evacuating residents may be vulnerably exposed to the atomic leaks around the docking port. This must be done as soon as possible, and consequently the operation control faction should undock the needed amount of shuttles at the gate to make ready for immediate evacuation.

5.7.6. Blackout

If all electricity flow is stopped on Divinity, either temporarily or permanently, the first thing to do would be to activate the emergency power generators to recover order. Their powers will not be enough to repower all the ceilings of Divinity, but they will be able to light a place where residents of each sector can gather together to verify each other's presence. After being sure everyone is safe, emergency managers will analyze the cause of the breakdown. If the situation is easily fixable, residents will wait for a while for experts to fix and go back to their everyday businesses after. However, if the crisis is a permanent one, residents should leave Divinity in the fashion mentioned formerly, with emergency electric generators prepared in the docking systems.

6. Economy and Industry

6.1. Tourism

Let's see this chart, made by EU in 2014, in EU, average 55% of citizen had more than one-day trip and had more than 4-day trip. Average expense of these tourist was approximately 8% of their country GDP, in other hand, twelve thousand million euro. When we consider average of GDP increase and inflation rate, people's total expense per GDP will maintain 8%. And if we consider space tour fee is going down rate per year, it can be possible to get space tour in summer holiday. Imagine this, you've got 1 week of summer holiday, what can be your choice? Make a BBQ party and swim in beach around resort like all other summer? It's bored. If you can spend one week in Divinity with same amount of money, the size of memory has huge difference. In Divinity, there are many facilities for tourists like Starward hotel and Quidditch arena in microgravity area. Furthermore, 500km from Earth, this position can be another strong point for holiday in Divinity. Let's see simple example in below.

6.1.1. Divinity Walk

Did you ever visit CN tower in Canada? At CN tower, there is one extreme sport named 'edge walk'. User, who lean on safety line, walking around tower on foothold. Like this program, we operating similar program named 'divinity walk'. User of divinity walk wearing EVA suit, walking around microgravity area. User can see and enjoying great view in there. The earth and moon will seeing just front of your eyes.

6.2. Extraterrestrial Materials Processing

Extraterrestrial Materials Processing was described in detail at section 4.4.3 Sector III.

6.3. Spacecraft Fabrication

The history of space exploration was first written by governments of powerful nations. Because of astronomical costs it took to manufacturing spacecraft, only few national and international agencies such as NASA, Roskosmos, ESA²¹ and JAXA²² had the capacity to build launch vehicles and send astronauts or cosmonauts to and beyond Earth orbit. But this decade has seen a boom of the commercial space industry, with launch vehicles and spacecraft manufacturing technologies expanding out into the private sector. The authors of Divinity see that if this trend continues, a spacecraft fabrication base in space will tap into one of the fastest growing industries of the century, and will play a pivotal role in the history of humankind as it reaches out to its next frontier.

The product that will provide many advantages and most expensive one, Satellite. Most popular criteria of satellite classification are existence of pilot in satellite. We call the satellite without pilot as an unmanned satellite. In other word, we call the satellite with pilot as a manned satellite. Manned Satellite carry humans, so life support system is required. When the LSS stop or battery, fuel is finished the satellite's life is over. Unmanned satellite's life is over when battery is finished. Its mission doesn't stop even without enough fuel. Unmanned satellite is not very hard to build. Some of university laboratories such as Texas university²³ develop the space satellite. Also few civilians have developed

²¹ European Space Agency

²² Japan Aerospace eXploration Agency

²³ <http://news.utexas.edu/campaigns/what-starts-here>

their own space satellite. In Korea, Ministry of Science, ICT and Future Planning has sponsored Korean Can-Satellite competition / camp to popularize Can-Satellite culture in Korea and enhance student's knowledge on satellite management from 2012 [27]. Even these can't get their orbit, it's possible to use as a real satellite.

However, when nation or huge company wants to have believable results, researchers do their best to make detailed satellite. As can see in picture [28], people wear clean clothes and make their own satellite. During they are making satellite, they have two weakness for building process. First one is freedom of design. They have to think about their rocket's size and payload. If the payload or size is not enough to earn great result as they need, they have two choices. One is use their rocket and endure low quality result, other one is use or develop other rocket to launch the satellite. Both choice have critical weaknesses. Secondary weakness is after launch care. Since most of the satellites launched are unmanned, people can't repair the satellite directly. Few ways they can try is use remote control panel to fix the trouble, or reboot the whole system. Also both choice have huge riskiness too. That's why we should make the satellite in space, just like divinity's spacecraft fabrication facility.

6.4. Perfect Crystals

In ISS, many experiments about crystal are already progressing. The Expedition Four, ISS Flight UF-1 has delivered the ZCG, Zeolite Crystal Growth Furnace Unit Facility [29]. Why crystal experiments are progressed in space? This research result can give answer about the question. "Scientists from the Netherlands and Japan have shown that a strong magnetic field can mimic the effects of microgravity when growing protein crystal. The new Earth-bound technique could provide a cheaper and easier way to produce crystals of the same quality as those grown aboard the ISS." [30] This research's goal is make artificial microgravity environment is earth. When divinity has completed, it can be much easier to process crystals under the microgravity environment. Which means, can get more high quality crystals.

How does microgravity effects on crystal's quality? Assume that a crystal is processing under the gravity. While gravity is pulling all masses toward earth, all fluids action is influenced by power they took. Heavier molecules go down; lighter molecules go up. Also fluid's flowing influenced. While gravity is forcing on fluid, every action of the atom is interpreted by their height. Under the microgravity, there is no standard for up and down. Molecules get maximum degree of freedom²⁴ for its action. So fluid structure in microgravity state is looks like magical phenomena. As you can see the picture [31] below, atoms in microgravity aligns only by their interaction. Under the Microgravity, atoms or molecule's activity are even. By the microphysical interpretation, That's the reason of why crystallization in space is much better than in earth [31].

²⁴ Degree of Freedom is the number of values in the final calculation of a statistic that are free to vary. The number of independent ways by which a dynamic system can move without violating any constraint imposed on it.

Figure 36. A close-up view of atoms in a germanium crystal [31]

6.5. Sports

Few sectors of economy have as many global participants as sports. From sports that are played in leagues like football, baseball, and basketball to sports that are played in national athletes like the world Olympics and the World Cup, sports see global interest in the magnitude of billions fans [32]²⁵, a market that generates hundreds of billions of U.S. dollars [33]²⁶. While project Divinity houses many industries, the sports industry will prove itself to be vastly different than others. For almost all other industries Divinity is paid in contracts by institutions, where the material (extraterrestrial materials processing, spacecraft fabrication, and perfect crystals) or intellectual (research institutions, medical institutions) benefits are the factor for profit. Only tourism and sports are “service industries” where revenue is generated from the expense of service and the provision of unique experiences.

While both tourism and sports are economy of the service industry, they have quite varying characteristics. Tourism, for one, consumes more effort in part of the organizers as tourism plans, tourism facilities, and especially the life support and adaptation of tourists in microgravity take

²⁵ Note that billions of fans accounts for more than half the world’s population. According to statistics by Robert Wood of Topend Sports, soccer and association football are estimated to have a fan base of 3.5 billion people, cricket 2.5 billion, field hockey 2 billion, tennis 1 billion, volleyball 900 million, table tennis 850 million, baseball 500 million, golf 450 million, basketball 400 million, and American football 400 million [32]. It is actually quite difficult to measure the amount of fans each sport has, as the definition of “fans” by itself is yet controversial. Robert Wood took into account various national / international surveys to come up with the above result. Note that the number above gives the fan base for each sport, and the combined population of sports enthusiasts, if it allows such definition, is less than the sum of each population as many people are fans of multiple sports at one time.

²⁶ A study conducted by A. T. Kearney, Inc. in 2011 estimates the global sports industry to be of value between 350 and 450 billion euros (480-620 billion U.S. dollars.) The largest single market for sports is soccer, whose worldwide sports events market, defined as all ticketing, media, and marketing revenues is estimated to be around \$28 billion / year.

immense amount of coordination and planning. Yet even with this amount of effort, the benefit, or the product of such efforts, are given only to the passengers who actually come aboard Divinity.

Sports, on the other hand, shows greater potential for long-run revenue as its products are not only limited to those who pay large sums of money to come aboard settlement Divinity. Even for terrestrial sports, only a small sum of the revenue comes from ticket sales, while the larger portion comes from broadcasting the show and the advertisement included in the arena. Much is the same for microgravity sports.

Broadcasting of sports played on Divinity to stations on Earth will generate not only income, but also public interest to the microgravity environment that attracts potential tourists and investments. This is why sports, while only one of many schemes to liven the economy on Divinity, is so crucial to the project's success in the long run.

7. Conclusion

The Divinity space settlement is the first endeavor to construct a small city in space. While Divinity is not the first space station to orbit Earth, it will nonetheless be the first international effort to create an environment where more than one generation is expected to reside.

Divinity's construction context is a time when commercial spaceflight has become powerful and lucrative enough to overshadow its governmental counterparts, and space tourism has become a norm for higher-earning families with the advent of multiple orbiting hotels. It is a time where simple viewing of Earth from space is not a novelty any longer, and the incentive is present to construct a foundation that will enable much bigger activities.

This will also be a time when deep space exploration has fully begun, with the first settlers arriving on Mars. More permanent moon bases and asteroid resources processing facilities are needed, as well as environment to build larger spacecraft capable of voyaging out further into space. Project Divinity is born upon such predictions, to become the first true space "city."

Divinity space settlement will tap into years of experience of constructing orbital hotels in Equatorial Low Earth Orbit (ELEO), where radiation shielding is not needed in excess of the structural mass already required for the base hull. Divinity will also tap into studies in microgravity which will solidify our expectations that the human biology can adapt to rotation rates more than 1 rotation per minute, consequently enabling the settlement to be smaller and easier to construct. As such, settlement Divinity will have a base radius of 200 meters, rotating at a rate of 2.114 rotation per minute to provide 1g of acceleration at its rim.

The rotation part will have the shape of a hybrid torus that allows for maximum structural integrity from the minimum materials. Residences will be provided to accommodate for up to 10,000 inhabitants at the torus, with many life support systems occurring in the non-rotating segments. The interior of the torus will look like that of a cruise ship, compact yet luxurious in quality. The residence will be eight stories tall above "ground level" with the top being used as a garden for psychological and environmental merit. The torus will be 65 meters wide at the ground, its width tapering away to the top, 45meters away from the ground. A double-lane road lines the middle of the width.

Beneath ground level is an "accessible level" of height 5m, housing communal centers with shopping places and restaurants and other cultural exquisites. Beneath the "accessible level" is a 6m-high "inaccessible level" where life support such as water treatment, waste management and backup servers and generators are located. The presence of water tanks beneath and around the residences provide extra radiation shelter to the residences.

To the top of the torus are two skytram lines, with six stations equally spaced around the upper circumference of the torus. These stations are situated right below the transfer spokes, having the dual purpose of loading and unloading of passengers and cargo from the non-rotating segment.

The non-rotating segment is built around the Central Hub, a 15m-radius shaft that connects all the other parts from top to bottom. Unpressurized, the Central Hub takes materials and passengers from one point of the settlement to another. Its inner surface is lined with horizontal and vertical railways upon which transport pods and transport robot arms move. Transport pods carry passengers and small cargo while transport robot arms carry larger pieces of cargo, usually for industrial purposes.

The Industrial Complex is a 140m-diameter, 25m-deep warehouse that can be compartmentalized and customized to suit that industry's needs. The Top of the Industrial Complex is made of retractable tiles so that spacecraft or celestial structure made within the Industrial Complex can be deployed right from the Divinity settlement. At the outer edge of the Industrial Complex are offices and airlocks that house office workers and factory managers in a pressurized environment.

The Microgravity Complex is a series of cylinders of different diameters and heights that house the settlement's community and high-technology industries. The Complex is divided into three sectors each of which has its own unique characteristics.

For service and tourism, two hotels, one starward and the other Earthward operate in Sector I and Sector II, respectively. Sector II is the sector most directed towards the transient population, with a Sports Quarter, Culture Quarters, and a Tourism Quarter. While the Culture Quarter strives to bring maximum enjoyment and experience to tourists on the settlement, the Sports Quarter have more in mind the potential visitors, broadcasting its microgravity games to the terrestrial population. For Project Divinity, the authors have developed its own sport "Quidditch" which the authors hope will give a prospect of how a sports economy will work in Divinity or any settlement of the like.

For life support, Sector I is mainly used to provide the oxygen and food for use in the residential torus and hotels. For agriculture, project Divinity uses aeroponics to supply the hundreds of tons of food required to maintain its population.

For industry and research, Sector III houses various high-tech industries such as extraterrestrial resource processing, pure crystal manufacture, material research laboratory, and the biology research laboratory. For lighter, mechanical engineering, the Assembly Yard takes in cargo from incoming spacecraft and proceeds to transport it up to the Industrial Complex. The Assembly Yard also takes care of maintaining, refueling, and repairing spacecraft, an economy that will prove lucrative in the coming space age. The Docking Port can service up to 300 spacecraft at a time, with its unique rail system meaning that docking of spacecraft can always be done where it's easiest – the bottom rail – and the spacecraft transported to other parts of the hemisphere for short-term or long-term parking.

8. References

- [1] A. Globus and J. Strout, "Orbital Space Settlement Radiation Shielding," 2015.
- [2] A. Globus, S. Covey and D. Faber, "Space Settlement: an Easier Way," 2015.
- [3] A. Globus and T. Hall, "Space Settlement Population Rotation Tolerance," 2015.
- [4] Softschools.com, "Orbital Velocity Formula," [Online]. Available: http://www.softschools.com/formulas/physics/orbital_velocity_formula/76/. [Accessed 23 November 2015].
- [5] The 1975 Summer Faculty fellowship Program in Engineering Systems Design, "Space Settlements: A Design Study," NASA, Washington, D.C., 1975.
- [6] W. V. Braun, "Will Mighty Magnets Protect Voyagers to Planets?," *Popular Science*, pp. 98-100, 198, January 1969.
- [7] NASA, "Constellation Program: America's Spacecraft for a New Generation of Explorers The Orion Crew Exploration Vehicle," NASA Lyndon B. Johnson Space Center, Houston, 2006.
- [8] SpaceX, "SpaceX Dragon spacecraft facts," Spaceflight Now, 2014.
- [9] G. Crouch, "Researching the Space Tourism Market," in *Annual Conference Proceedings, Travel and Tourism Research Association*, 2001.
- [10] D. Manuel, "Inflation Calculator," 2015. [Online]. Available: <http://www.davemanuel.com/inflation-calculator.php?theyear=1873&amountmoney=7000000>. [Accessed 13 November 2015].
- [11] XPRIZE Foundation, "Google Lunar XPRIZE," 2015. [Online]. Available: <http://lunar.xprize.org/about/overview>. [Accessed 13 November 2015].
- [12] A. Kuhn, "China Aims High For Its Space Program," *National Public Radio*, 22 July 2009.
- [13] M. Wall, "Asteroid Mining May Be a Reality by 2025," *Space.com*, 11 August 2015.
- [14] D. Spector, "The Asteroid Nearing Earth Could Be Worth \$195 Billion — Here's The Plan To Mine The Next One," *Business Insider*, 13 February 2013.
- [15] S. Gary, "Survey finds not all meteors the same," *ABC Science*, 22 December 2011.
- [16] A. Turgeon, "Encyclopedic Entry - Meteoroid," National Geographic, [Online]. Available: <http://education.nationalgeographic.org/encyclopedia/meteoroid/>. [Accessed 3 December 2015].

- [17] B. Dunbar, "NASA Digital Learning Network - Asteroids," NASA, 29 August 2014. [Online]. Available: <https://www.nasa.gov/offices/education/programs/national/dln/events/Asteroids.html#.VtMl0f195D9>. [Accessed 3 December 2015].
- [18] M. E. kalinski, "Hypervelocity Impact Analysis of International Space Station Whipple and Enhanced Stuffed Whipple Shields," Naval Postgraduate School, Monterey, 2004.
- [19] B. Dunbar, "The ISS to Date (03/09/2011)," NASA, 21 March 2011. [Online]. Available: http://www.nasa.gov/mission_pages/station/structure/isstodate.html. [Accessed 15 November 2015].
- [20] H. Kolm, "Mass Driver Up-date," *L5 News*, September 1980.
- [21] M. T. Franklin, "Space Elevator Analysis Spreadsheet," 2011.
- [22] Planetary Resources, "Why Asteroids Are The “Low Hanging Fruit Of The Solar System”," [Online]. Available: <http://www.planetaryresources.com/asteroids/why-asteroids/>. [Accessed 21 December 2015].
- [23] Nuclear Energy Agency, OECD, "Introduction of Thorium in the Nuclear Fuel Cycle: Short- to long-term considerations," Nuclear Science, 2015.
- [24] D. E. Baumgartner and L. GmbH, "White Light LED Technology with Increased Efficiency and Variable CCT," *LED Professional Review*, no. 5, pp. 26-29, 2008.
- [25] International Quidditch Association, "About," 2015. [Online]. Available: <http://iqaquidditch.org/about.php>. [Accessed 13 November 2015].
- [26] International Quidditch Association, "The Basics," 2015. [Online]. Available: <http://iqaquidditch.org/rulebook.php>. [Accessed 13 November 2015].
- [27] CANSAT Competition, "CANSAT Competition Korea," [Online]. Available: <http://cansat.kaist.ac.kr/>. [Accessed 12 January 2016].
- [28] S.-Y. Noh, "인공위성 벤처 '썬트렉아이', 코스닥 '궤도진입' 추진," *HelloDD*, 14 February 2008.
- [29] S. Roy, "Zeolite Crystal Growth Furnace (ZCG)," NASA, 1 November 2001. [Online]. Available: <http://www.nasa.gov/centers/marshall/news/background/facts/zeolites.html>. [Accessed 14 January 2016].
- [30] K. Kleiner, "Magnetic gravity trick grows perfect crystals," *New Scientist*, 10 August 2007.
- [31] K. Erickson, "Conjuring Crystals - NASA Scientists are figuring out the physics behind a seemingly magical way to produce high-quality crystals," *NASA Science News*, 2001.

- [32] R. Wood, "World's Most Popular Sports by Fans," 2006. [Online]. Available: <http://www.topendsports.com/world/lists/popular-sport/fans.htm>. [Accessed 14 November 2015].
- [33] H. Collignon, N. Sultan and C. Santander, "The Sports Market - Major trends and challenges in an industry full of passion," A. T. Kearney, Inc., Chicago, 2011.
- [34] Y. Clearwater, "NASA ArtSpace - Frank Pietronigro: Zero-Gravity Space Artist," 2 April 2013. [Online]. Available: http://www.nasa.gov/connect/artspace/creative_works/feature-frank-pietronigro.html. [Accessed 13 November 2015].
- [35] UCR ARTSblock, "Free Enterprise, The Art of Citizen Space Exploration - Frank Pietronigro," 7 January 2013. [Online]. Available: <http://sites.artsblock.ucr.edu/free-enterprise/frank-pietronigro/>. [Accessed 13 November 2015].
- [36] B. Hubscher, "RED Epic Dragon Camera Captures Riveting Images on Space Station," 31 July 2015. [Online]. Available: http://www.nasa.gov/mission_pages/station/research/news/red_epic_dragon_camera. [Accessed 13 November 2015].
- [37] A. Tarantola, "Astronauts capture stunning 4K video of antacid bubbles aboard the ISS," 12 October 2015. [Online]. Available: <http://www.engadget.com/2015/10/12/NASA-4k-ISS-space-bubbles/>. [Accessed 13 November 2015].
- [38] J. Newton, "Watch the mesmerizing moment astronauts create a floating mass of bubbles in space by dissolving Alka-Seltzer in water," 12 October 2015. [Online]. Available: <http://www.dailymail.co.uk/news/article-3269066/Watch-mesmerizing-moment-astronauts-create-floating-mass-bubbles-dissolving-Alka-Seltzer-water-space.html>. [Accessed 13 November 2015].
- [39] US Quidditch, US Quidditch Rulebook, 9th ed., US Quidditch, Inc., 2015.
- [40] US Quidditch, Inc., "US Quidditch Press Kit," 2015.
- [41] M.-S. Chae and B.-J. Chung, "Radiation Exposure of an Astronaut subject to Various Space Radiation Environments and Shielding Conditions," *Journal of the Korean Society for Aeronautical & Space Sciences*, vol. XXXVIII, no. 10, pp. 1038-1048, 2010.
- [42] Wikipedia, "Falcon 9 v1.0," 20 July 2015. [Online]. Available: https://en.wikipedia.org/wiki/Falcon_9_v1.0. [Accessed 14 November 2015].
- [43] Wikipedia, "Falcon Heavy," 12 November 2015. [Online]. Available: https://en.wikipedia.org/wiki/Falcon_Heavy. [Accessed 14 November 2015].
- [44] Wikipedia, "International Space Station," 11 November 2015. [Online]. Available: https://en.wikipedia.org/wiki/International_Space_Station. [Accessed 14 November 2015].

- [45] Wikipedia, "ASHRAE 55," 13 August 2015. [Online]. Available: https://en.wikipedia.org/wiki/ASHRAE_55. [Accessed 15 November 2015].
- [46] H. Tyler, S. Stefano, P. Alberto, M. Dustin and S. Kyle, "CBE Thermal Comfort Tool for ASHRAE 55," Center for the Built Environment, University of California Berkeley, 2013.
- [47] SpaceX, "Twitter: SpaceX successfully deployed 11 satellites into Low Earth orbit and landet back on ground for the first time in history," Twitter, 22 December 2015. [Online]. Available: <https://twitter.com/SpaceX/status/679114269485436928>. [Accessed 23 December 2015].
- [48] NASA, "Diagram showing the Lagrange points for two masses," NASA, 1999.
- [49] T. A. Heppenheimer, Colonies in Space, Warner Books, 1997.