

WONN

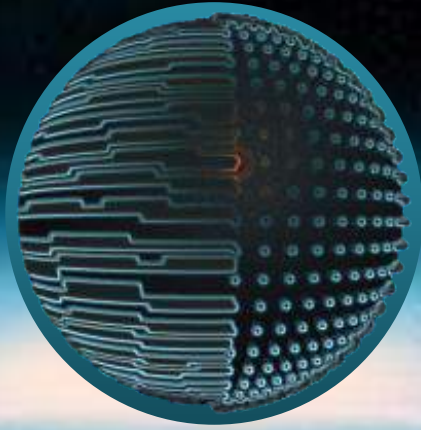

# NASA SPACE SETTLEMENT DESIGN CONTEST 2014

TEAM MEMBERS – LARGE TEAM, 10 GRADE

APEEJAY SCHOOL, Jalandhar, Punjab, India - 144001

Sno.	Name	Grade	Age
1	Aditya Pratap Singh	10	15
2	Amareen Sandhu	10	16
3	Hatinderpal Singh Ghotra	10	15
4	Hetarth Chopra	10	16
5	Karan Chouhan	10	16
6	Prajwal Mahajan	10	15

VOMM

Under the guidance of, Mr. Emmanuel Ratnaraj

# ACKNOWLEDGEMENTS

Framing of our project VONA would never have been accomplished without the valued guidance of so many people. We take this opportunity to express our profound gratitude to:

First of all we would like to thank the Almighty God for his blessings who gave us inner strength and determination to work hard and complete VONA. Next, we are grateful to NASA for providing this unique platform of Space Settlement Design Competition which changed our outlook towards space and its exploration and helped us learn valuable lessons. Then we also thank our school principal Ms Meera Javed for her valuable support and encouragement.

Our teacher, guide and mentor Mr Emmanuel Ratnaraj for his honest criticism and supervision because of which we could improve our work. Because of his round the clock supervision we were able to complete the settlement in time. He also provided technological and mental support to the team because of which we were put on the right track for the addition of feasible technologies.

Mr Harjeet Singh for helping us learn 3D modelling software. His dedication in teaching us the software can be shown in the structure. His excellent guidance propelled us towards the completion of the wonderful structure.

We also thank our parents for providing moral support, and motivation to us. This settlement will be impossible if our parents wouldn't have provided support for the program. We thank Mr Varun Mahajan for providing academical support.

We thank especially Dr Michio Kaku. Because of his episodes on The Science Channel we were able to pick out a few ideas from the shows and put up in the settlement design. His episodes of "Sci-Fi Science" told us many new things which are placed in the settlement.

We also thank Rodford Edmiston Smith for his keen help.

Finally we thank Autodesk® for providing such a user friendly software called 3Ds max.

The preparation of this project has been a fascinating experience and we had the time of our life while researching and compiling the document. The overall experience of imagining the survivability of civilians in the horizons was enthralling. We are really pleased that all the people mentioned above lifted our spirits time to time and supported us throughout the project.

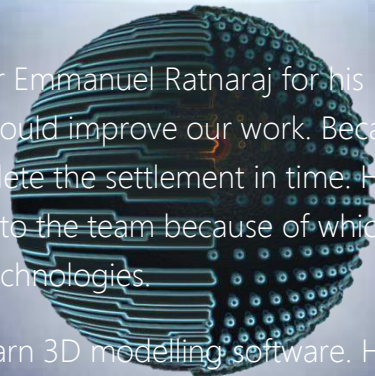

# INDEX

Serial No.	Chapter	Page Number
<b>A</b>	<b>Acknowledgements</b>	
<b>Section 1.0</b>	<b>Introduction</b>	1.1-1.5
Ch.1.1	Executive summary	1.1-1.2
Ch.1.2	Inspiration for name VONA	1.2
Ch.1.3	Location & Orbit	1.3-1.5
<b>Section 2.0</b>	<b>Structural Overview</b>	2.1-2.35
Ch.2.1	Introduction	2.1
Ch.2.2	Major Components	2.2-2.9
Ch.2.3	Minor Components	2.9-2.13
Ch.2.4	Symmetry & Dimensions	2.13-2.14
Ch.2.5	Construction Sequence And Material Application	2.15-2.23
Ch.2.6	Internal Structure	2.23-2.31
Ch.2.7.1	Martian Base	2.32-2.34
Ch.2.7.2	Lunar Base	2.33-2.35
<b>Section 3.0</b>	<b>Life Support</b>	3.1-3.23
Ch. 3.1	Pseudo-Gravity Generations	3.1-3.2
Ch. 3.2	Air Management	3.3-3.8
Ch. 3.3	Water & Waste Management	3.9-3.15
Ch. 3.4	Electricity Generation	3.16-3.20
Ch. 3.5	Agricultural Activities	3.20-3.23
<b>Section 4.0</b>	<b>Operations &amp; Infrastructure</b>	4.1-4.23
Ch.4.1	Illumination	4.1-4.3
Ch.4.2	Radiation Protection	4.3-4.6
Ch.4.3	Transport	4.6-4.11
Ch.4.4	Recreation	4.11-4.13
Ch.4.5	Research & Industries	4.14-4.15
Ch4.6	Communication	4.16-4.23
<b>Section 5.0</b>	<b>Human Factors</b>	5.1
Ch.5.1	Demography	5.1-5.2
Ch.5.2	Residential Facilities	5.3-5.4
Ch.5.3	Education	5.5
Ch.5.4	Government	5.5-5.9
<b>Section 6.0</b>	<b>Finance &amp; Schedule</b>	6.1-6.3
Ch.6.1	Business & Cost	6.1-6.2
Ch.6.2	Schedule	6.3
<b>B</b>	<b>Conclusion</b>	
	<b>Bibliography</b>	

## ABBREVIATIONS AND OTHER NAMES

<b>Abbreviation</b>	<b>Full Form</b>
<b>AES</b>	<b>Advance Encryption Standard</b>
<b>AU</b>	<b>Astronomical Unit</b>
<b>BCC</b>	<b>Body Centric Cubic Carbon Allotrope</b>
<b>BoPET</b>	<b>Biaxially Oriented Polyethylene Terephthalate</b>
<b>CQD</b>	<b>Colloidal Quantum Dot</b>
<b>EDTA</b>	<b>Ethylene Diamine Tetra-Acitate</b>
<b>GPa</b>	<b>Giga Pascal</b>
<b>HEPA</b>	<b>High Efficiency Particulate Air</b>
<b>HiVOLT</b>	<b>High Voltage Orbiting Long Tether</b>
<b>HTPB</b>	<b>Hydroxyl Terminated PolyButadine</b>
<b>IOMMU</b>	<b>Input Output Memory Management Unit</b>
<b>IPC</b>	<b>Impenetrable Composite</b>
<b>L4</b>	<b>Lagrangian Point 4</b>
<b>LiAgX Zeolite</b>	<b>Lithium Silver Zeolite</b>
<b>LTE 2.0</b>	<b>Long Term Evolution</b>
<b>MPa</b>	<b>Mega-Pascal</b>
<b>MPD</b>	<b>Magneto Plasma Dynamic Thrusters</b>
<b>MPPS</b>	<b>Most Penetrating Particle Size</b>
<b>NCCDD</b>	<b>Neonatal Colorimetric Carbon Dioxide Detector</b>
<b>OAUGDP</b>	<b>One Atmosphere Uniform Glow Discharge Plasma</b>
<b>OTP</b>	<b>One Time Pad</b>
<b>PCB</b>	<b>Polychlorinated Biphenyls</b>
<b>PDSDC</b>	<b>Polystyrene-Dimethyl-Siloxane-Di-block-Co-polymer</b>
<b>PICA-X</b>	<b>Phenolic Impregnated Carbon Ablator - Space X</b>
<b>PPDSDC</b>	<b>Polystyrene-Poly-Di-Methylene-Siloxane-Di-Block-Co-Polymer</b>
<b>RO</b>	<b>Reverse Osmosis</b>
<b>SMES</b>	<b>Superconducting Magnetic Energy Storage</b>
<b>SOLED</b>	<b>Stacked Organic Light Emitting Diode</b>
<b>SPD</b>	<b>Suspended Particle Display</b>
<b>SPS</b>	<b>Solar Powered Satellite</b>
<b>SWNT</b>	<b>Single Walled Nanotubes</b>
<b>TDS</b>	<b>Total Dissolved Solids</b>
<b>UF</b>	<b>Ultra Filtration</b>
<b>UHMWPE</b>	<b>Ultra High Molecular Weight Polyethylene</b>
<b>VACNT</b>	<b>Vertically Aligned Carbon NanoTube</b>
<b>VASIMR</b>	<b>Variable Specific Impulse Magnetoplasma Rocket</b>
<b>VPSA</b>	<b>Vacuum Pressure Swing Absorption</b>
<b>ZVIN</b>	<b>Zero Valent Iron Nanoparticles</b>
<b>Zylon</b>	<b>PolybenZoxazole</b>

*"I don't think the human race will survive the next thousand years, unless we spread into space. There are too many accidents that can befall life on a single planet. But I'm an optimist. We will reach out to stars"*

- Stephen Hawking, interview with Daily Telegraph, 2001

It's the 2040s, the Earth is clogged with humans, the stench of wretchedness is everywhere in the air. In such times of despondency when the horizons are full of consternation, appears a silver lining—a spark of hope, VONA. Illuminating what appeared to be hidden in the darks of human mind, highlighting the possibilities, which seemed conceited for the human race. This is the inspiration, the spur of ambition, the spark of hope.

VONA is the platform which ensures a secure habitat for the modern culture to survive in.

Gerard O'Neill the first person to explore into the areas where no man ever ventured, initiated the rationale of Space Settlement. His ideas gave the whole world a new mode of thinking; thinking out of the box. Creating a human empire in the cosmos that provides all the facilities which are indispensable to human living standards. Just building upon his ideas our team at Apeejay has prepared the proposal document of VONA. This brief text will take you to an expedition where we can show you EARTH 2.0.

#### **AIM:**

- Provide excellent conditions for living outside Earth.
- Provisions to earn money from the extraterrestrial resources.
- Provision of feasible technologies which are futuristic as well as innovation in the Design

**LOCATION:** The construction of VONA will start in 2041 in the Earth's Geosynchronous Orbit. While it is still in its initial phases, it will capture 3554 Amun asteroid. This asteroid will be taken to the Lunar Base for further execution. Selling its resources can fetch the settlement a potential \$ 22 trillion if we sell them to earth. Then VONA will be transferred to The Areosynchronous Orbit of Mars. This location can empower us to exploit the resources of Mars, Moon and Earth.

**STRUCTURE** VONA has a unique and innovative structure. The residential structure has been aptly named the "HYBRID" Torus due to its novel design. The Industrial Structure consists of wave like sections, inspired from water waves, which provide dedicated area for industrial and research facilities. There is also a discrete truncated torus with crop specific divisions named "Piraso" for Agricultural facility. The structure will be built upon extremely rigid materials which can safeguard VONA from any calamities. VONA is also safe from any Cosmic or any Solar Radiations that may perhaps harm the people. In addition it also has two docking ports which will be positioned on the extreme ends of the central cylinder.

**LIFE SUPPORT:** VONA has a fully functional life support system which will be used to accomplish the aim of the settlement to make the life of the people comfortable. This will have clean and reusable water, Clean Air without any

microbes, all types of flora and fauna for ample food, Excellent Climate with periodic change in seasons. VONA will also have provisions of electricity like Hyper Ex Solar panels.

**TRANSPORT AND RECREATION:** Transportation in as well as out of the settlement will be taken care of advanced Vehicles. External Transport will be carried out through the Docks using Vehicles powered by propellers like, MPD, VASIMR VX200, and future propellants like Helium-3 and Monoatomic Hydrogen. VONA has 0-g sport facilities in the central hub like Galactic Football, Virtusphere etc.

**HUMAN FACTORS:** Thriving in the space for such an elongated spell can be difficult for people to live. VONA will help the folks to cope up with psychological and physical problems. It is democratic in its terms and will hold regular elections for the proper administration.

**COMMUNICATION:** VONA will have to connect with Earth, Mars and Moon. This will be done using high tech Neutrino communication. This will be facilitated by Proton Beams

As we all know *Homo sapiens* have crowded the earth for over 10,000 years. VONA will elicit the upgrading of the *Homo sapiens* to homo futuris, explorers of the stars, reaching beyond infinity, galactic colonizers, and knowers of the unknown. Behold the race of post human intelligent species.

With all hope we present you our Settlement Design: VONA.

## CH. 1.0 INTRODUCTION

## INSPIRATION FOR NAME "VONA"

*"Everything that is done in the world is done by hope"*

- Dr. Martin Luther King, Jr.

One of man's wildest dreams, a dream that we wanted to achieve more than anything, a dream that made us think of endless possibilities, the dream of going to Mars. Man is ready to spend all their wealth to fulfill this dream, his dream of settling on the harsh and inhabitable locations of interstellar space. So in order to realize the dream of the humans we need to find something which can inspire the mankind to reach the stars. Planning of the VONA Space Settlement could not be possible unless we had our hearts warmed by Elpis (The greek spirit of hope) just as it did in Pandora's box. With inspiration from our warm hearts we named our project "VONA"

**Vona**  
(Icelandic):  
Hope, faith.

Location is an integral part of the settlement. Location decides the resources that could be attained, stability that could be achieved, exploration that could be made possible, the facilities that could be provided. The idea behind a good location is to find an area free from the extreme hostilities and inhospitable conditions that space provides in some locations. Practically no such location is possible in space, a location having lesser complications and an environment possible to live in is chosen.

While choosing the location of VONA we had different options. We could've used the traditional L4 Lagrangian point like most of the competitors choose or unfeasible and feebleminded location of Mars- Phobos L4 and Mercury.

VONA has multiple locations it will first reside in geosynchronous orbit of earth (where it will be constructed), followed by Hohmann transfer orbit which would transfer it to Mars Areosynchronous orbit.

### Possible Locations considered for the Space Settlement

The locations that were considered for the settlement are: Earth-Moon L4, Quasi-Zenith Orbit, Quasi Synchronous orbit of Mars, Mercury geostationary and Mars B orbit

### Preferred Locations

#### Earth geosynchronous orbit

The Earth Geosynchronous orbit is chosen as the initial location for VONA because of the asteroid 3554 Amun which will cross the earth's orbit on 23 March 2061 exactly at 6:30 pm. The Asteroid will be the closest to the Earth's Orbit at a distance of 0.2515374016697 A.U. This asteroid has been chosen for mining because the asteroid is rich in minerals. This asteroid contains \$ 22 trillion worth of minerals in it (theoretical). It has approximately:

- \$ 8 trillion worth Platinum
- \$ 8 trillion worth Iron And Nickel
- \$ 6 trillion worth Cobalt

#### Hohmann Transfer Orbit

The Hohmann Transfer orbit is chosen for transferring our settlement from geosynchronous

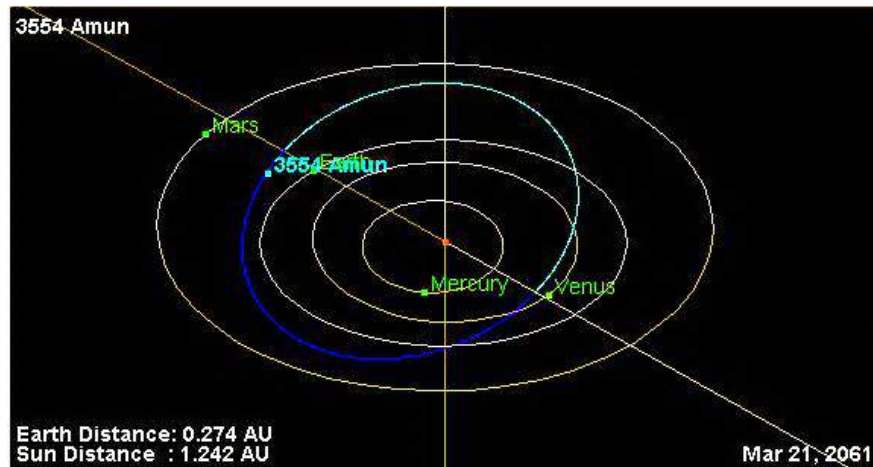

Figure 1.1 orbit of 3554 AMUN

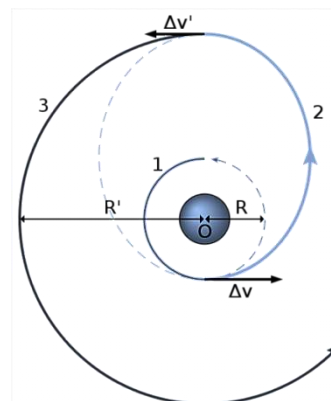

Figure 2.2 Hohmann transfer orbit



orbit to Mars Areosynchronous orbit. This orbit works in a way to bring a body from a lower orbit to another orbit. The orbital velocity will be needed to increase in order to transfer the body from one orbit to another. Considering the case of Mars the settlement will be revolved around the earth in geostationary orbit. Then two engines will be needed for an instantaneous orbital velocity which will help the settlement to break free from the orbit of earth. But impulse transfer orbit [which can be performed by low thrust engines] require more change in velocity and high accuracy of the bursts which require constant monitoring for the transfer. Then the Thrusters will help slow down the velocity before it reaches the Areosynchronous orbit. The thrusting will be done well before 1 month of reaching Areosynchronous. Then VONA will reach the Areosynchronous orbit and the Thrusters will be activated in such a direction that the settlement will fall in the orbit. This whole process will take 1 year and 3 months approximately.

### Mars Areosynchronous or Areostationary

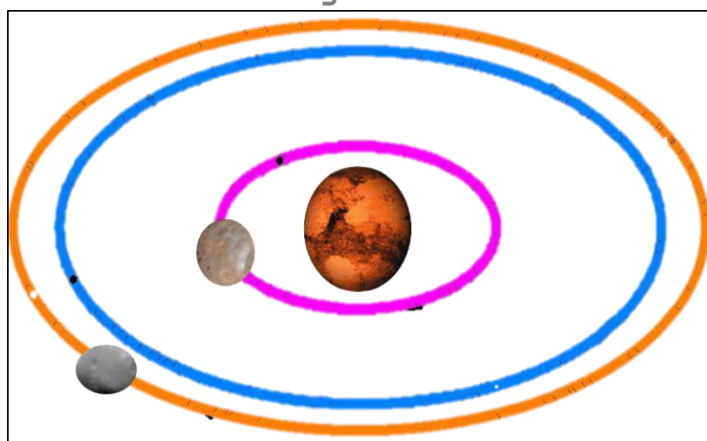

Figure 1.3 : The pink orbit is of Phobos, Orange of Phobos and Blue of VONA

of minerals. Additionally uninterrupted communication can be achieved between Earth, Moon, Mars, Phobos and Deimos using neutrinos. Stability of the orbit would be achieved with minimal thrusting due to sufficient distance from Phobos, chances of deflection under the influence of its gravitation field would be negligible. Moreover, Deimos' gravitation pull due to its low mass and small radius would not be of much influence. Due to its lesser distance from Mars, easy extraction would be possible.

This orbit is quite similar to geosynchronous orbit as it constantly faces 1 side of Mars and constantly receive goods without any delay.

### Considerable Dangers while Travelling to Location

While travelling to the location, the residents will face a number of risks. One of them is passing through the Van Allen belt. This belt is believed to be comprised of enormous amount of radiation all around and inside it. While some consider the amounts of radiation present there extremely harmful, others say that it does not matter. However, a way to avert the radiation from this belt is:

Areosynchronous orbit is basically the preferred Orbit for VONA. Sandwiched between the orbits of Phobos and Deimos, this orbit is stable and does not get deflected by the orbit of Deimos or Phobos. It is about 10,750 km away from Phobos, A small outpost and a small base can be constructed on Phobos & Deimos to enable the extraction

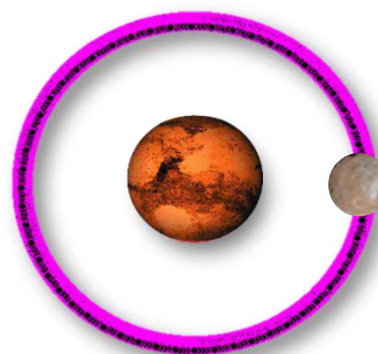

Figure 1.4 Orbital Decay of Phobos

## HiVOLT system

This concept was proposed by Russian physicist V.V.Danilov for reducing the

### Figure 1.5 HiVOLT System

theoretical radiation flux in the Van Allen belt to less than 1% within 2 months. The arrangement consists of five 100 km long conducting tethers deployed by satellites which would be charged to a high voltage for creating an electromagnetic field. This would create a safe passage through the belt.

# SECTION 2.0 STRUCTURAL OVERVIEW



The idea behind the structure of VONA is providing a hospitable and inhabitable condition in the harsh & hostile environment of Space. In addition to the above, VONA also delivers a milieu for industrialisation, experimentation, research and technological development. VONA has a well-planned organization of the structure to provide the elementary amenities to the citizens. VONA in addition to housing a massive a population of 16640, has unsurpassed residential and agricultural facilities along with animal husbandry; comfortable and luxurious recreational facilities; Spacious and appropriate industrial accommodations; Precisely considered, and feature-filled docking port; and much more.

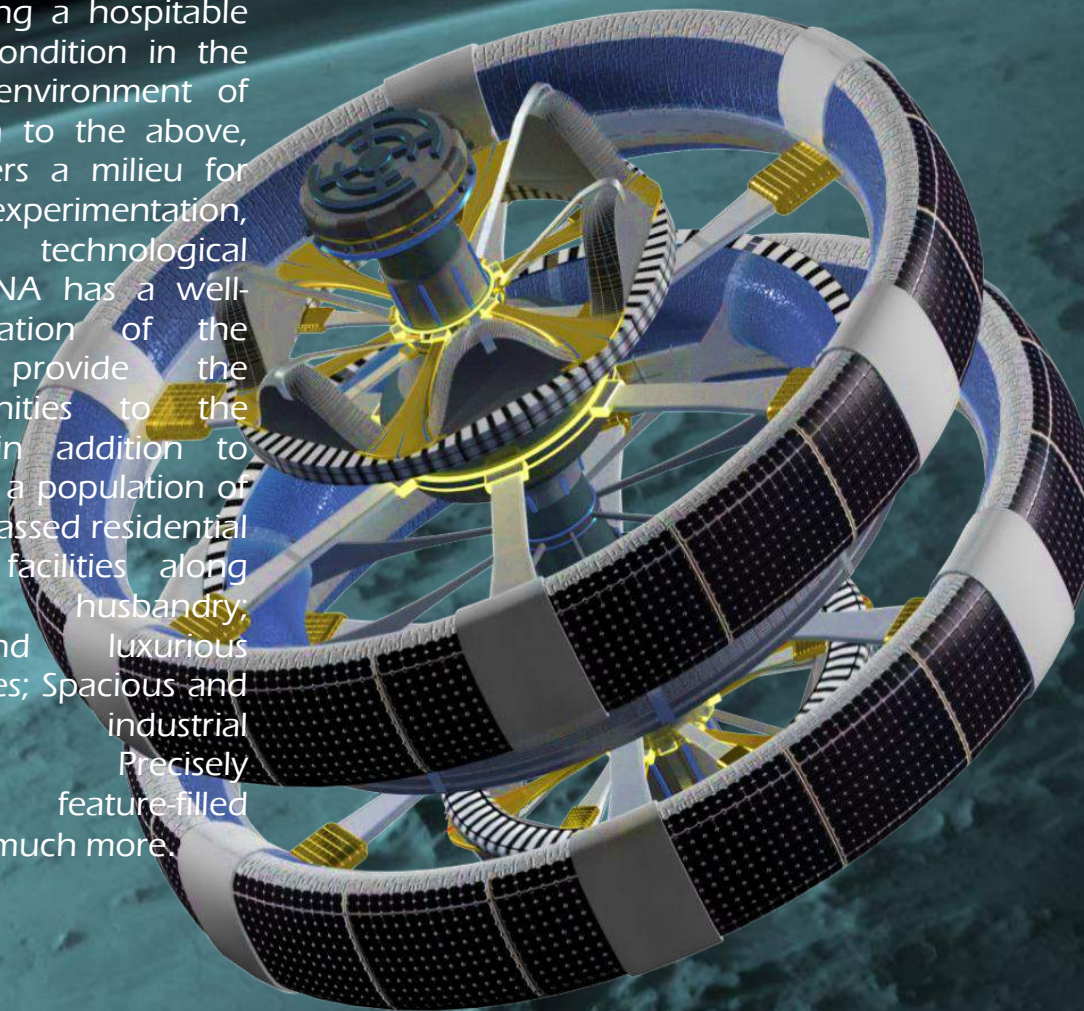

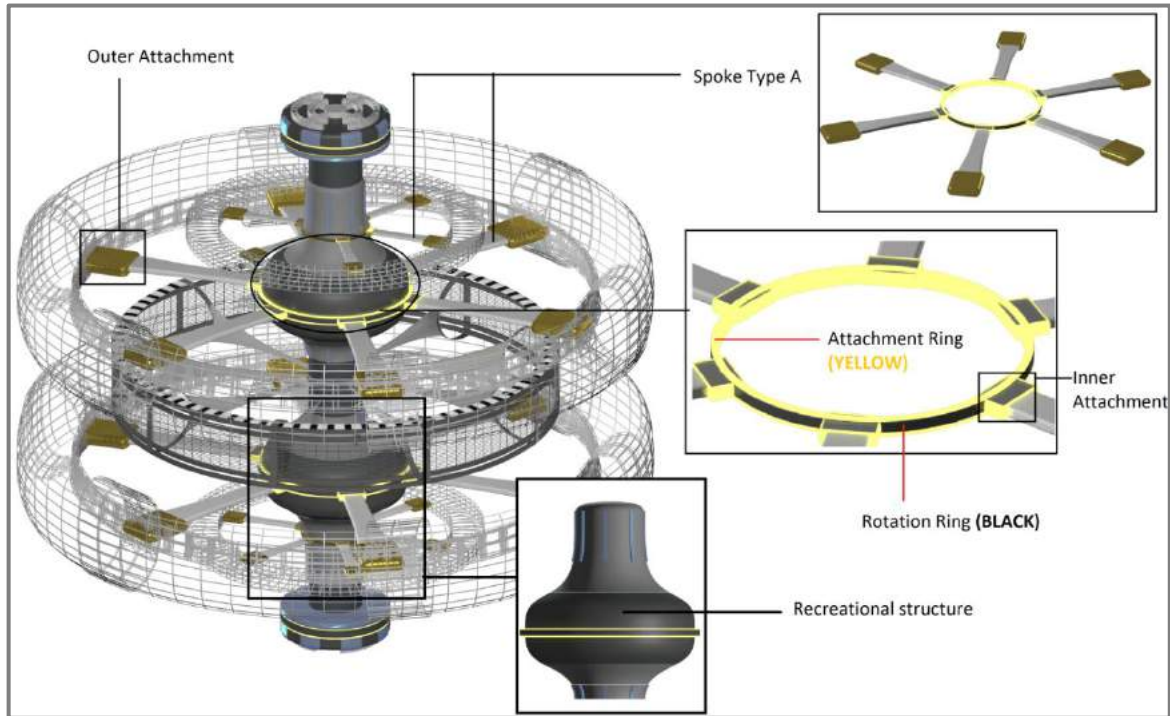
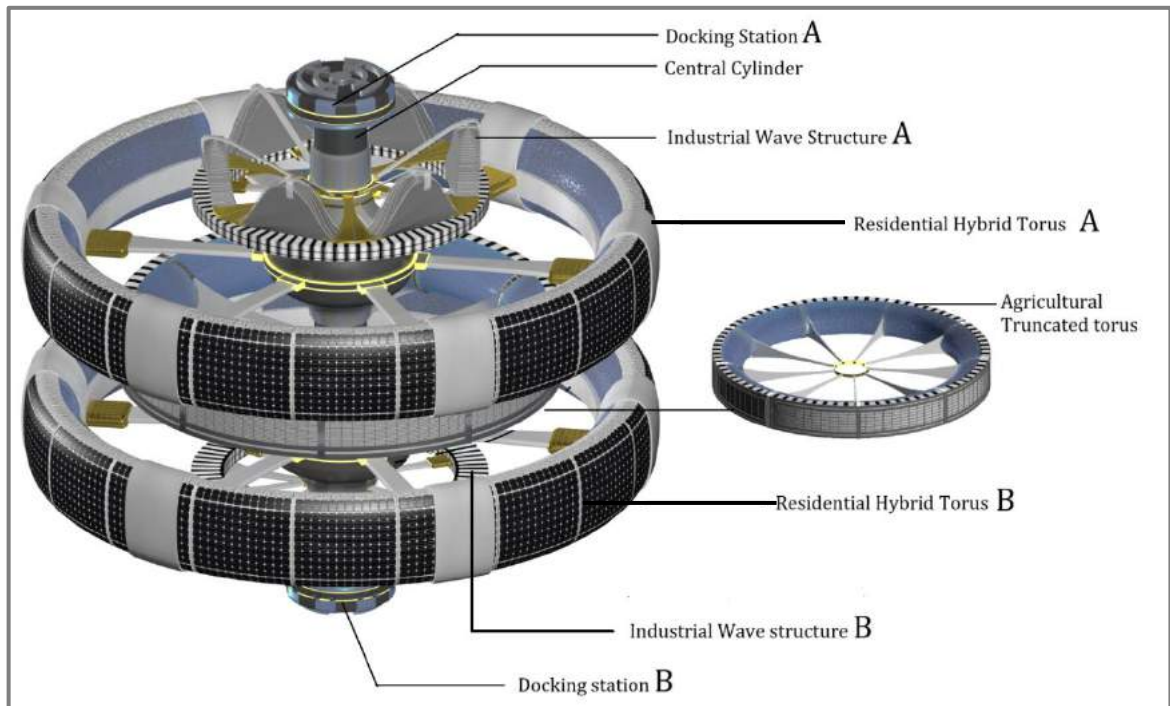

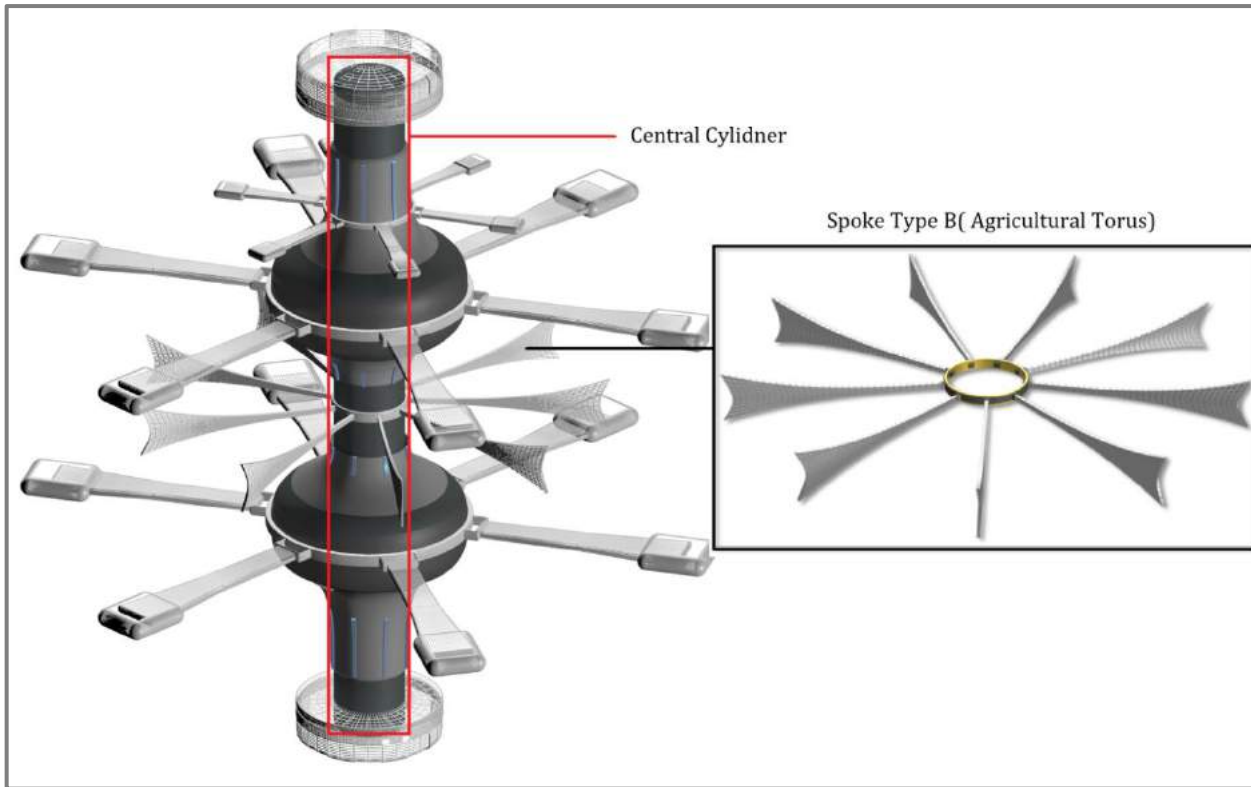

## MAJOR COMPONENTS

### RESIDENTIAL HYBRID TORUS

The residential structure tends to the fundamental purpose of VONA i.e. providing a home to a population of 16640. The inhabited structure is essentially a “HYBRID Torus” which is a fusion of the simple torus and the truncated

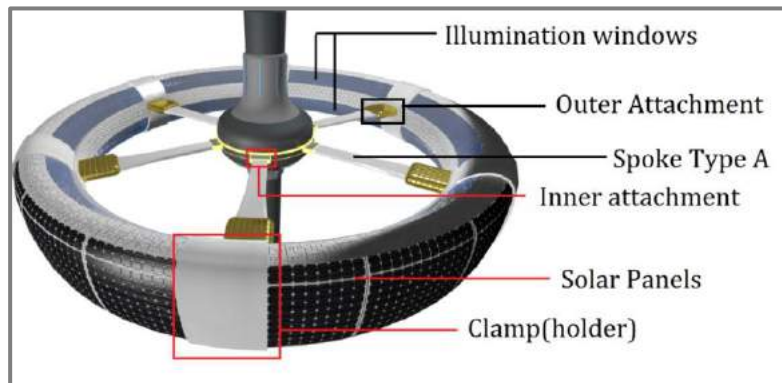

torus constituting the best of both designs into one. *Figure 2.2.1 Residential HYBRID Torus*

The HYBRID torus has a radius of about 1095m. For gravity generation rotation at a speed of 0.903rpm (resultantly producing 1g at the hull), is induced using the Rotation Ring Design-A attached to the recreation facility through the attachment ring A. The rotation ring, on the exterior is attached to the spokes which are connected to the HYBRID torus itself via clamps (holders).

It has a ground width of about 314m while the clamps (holders) have a width of 331m. The torus is crusted with layers of Hyper Ex solar panels (Quantum dot + Vertically Aligned Carbon Nanotubes) on the exterior and has a vertical clearance of approximately 178.5m.

Gravity fluctuations are prevented by the means of a uniform floor with a substantial and stable design. The floor has one residential corridor and 2 inclined transport corridors. Transparent windows are included for illumination.

## Shape for Residential Structure

SIMPLE TORUS

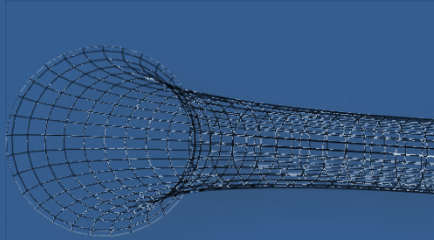

TRUNCATED TORUS

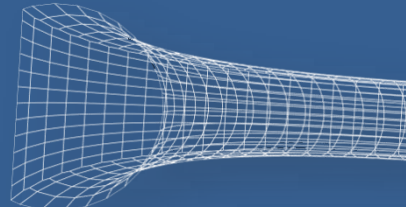

HYBRIDTORUS

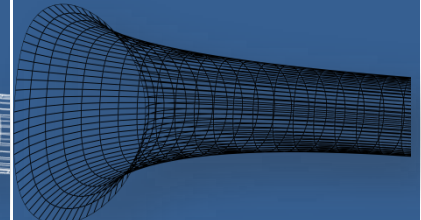

## FEATURES

### HYBRID TORUS:

The hybrid torus incorporates the advantages of the simple and truncated torus designs into a single structure. Like the simple torus, it does not have an edge or a corner because an edge in the structure has a tendency to break away or cause instability and wobbliness. In a simple torus, nearly half of the volume is wasted for construction of floor to prevent gravity fluctuations. But, in a hybrid torus, such wastage does not occur. The space left unused, although comparatively much lower, is utilized for construction of water pipeline and electrical wire system.

Fusing the Simple and Truncated Tori, we have created and coined the term "HYBRID TORUS"

### STRUCTURE PARAMETERS:

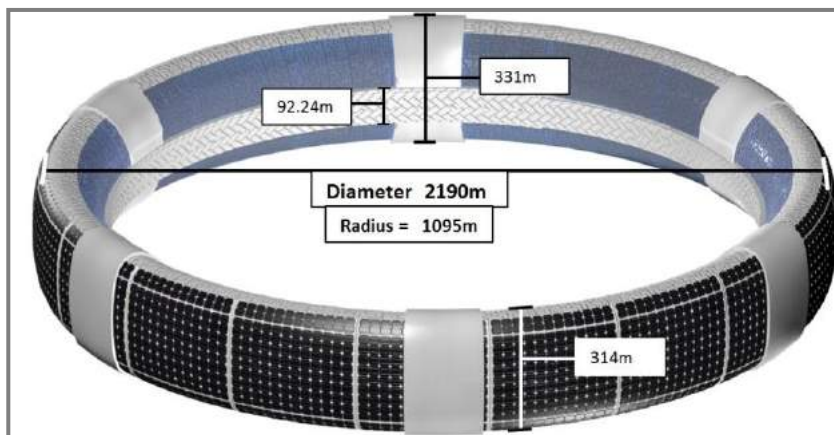

Figure 2.2.2 Residential HYBRID Torus

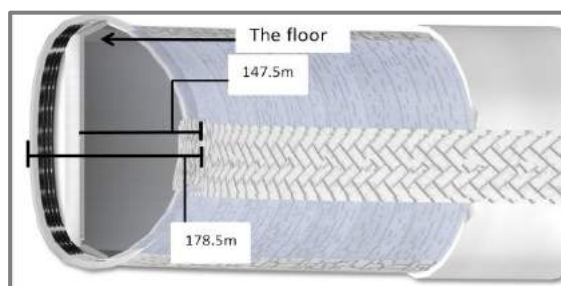

Figure 2.2.3 Cross Section of Residential HYBRID Torus

### AGRICULTURAL TRUNCATED TORUS

The agriculture subdivision has a pseudo segmented structure. It is internally separated into 9 segments called the agricultural pirasos (Filipino word meaning segment). However on the exterior, it appears like a monolithic structure. Each Piraso houses different type of agricultural activity. The pirasos are held together by a main frame and 4 sturdy rings (which also act as transport channels after construction is completed). Internally, the Pirasos are separated by 26.959m long structures called *Atmosphere Separation Corners* or *Seals* which help in maintaining a separate atmosphere, liquid and waste management systems for diverse crops in each Piraso. The radius of the agricultural area from the center is 772m with a ground width of 270m and 0.7g is the gravity produced. The transport rings have a radius of 777m and a vertical clearance of 5m.

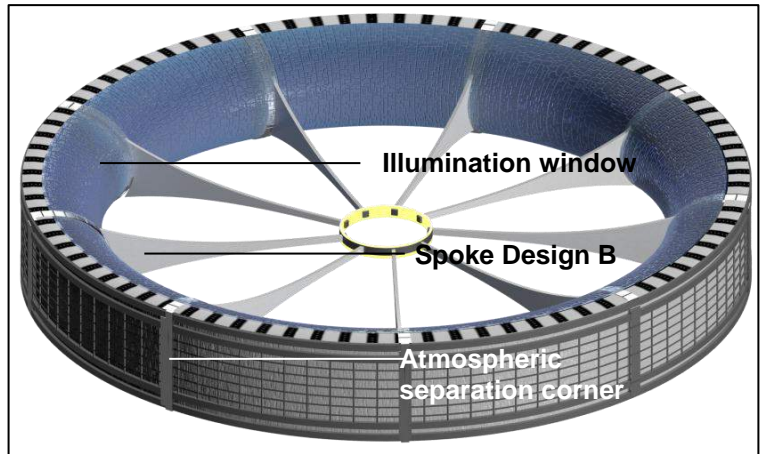
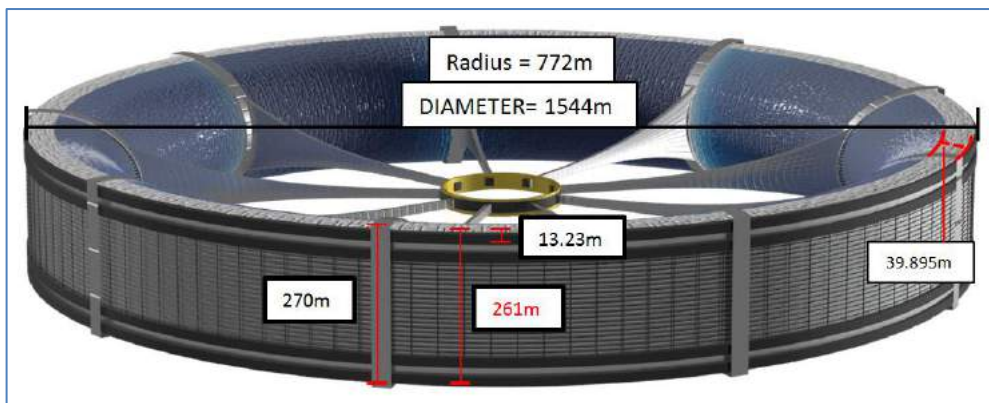

Figure 2.2.4 Agricultural Truncated Torus



### STRUCTURE PARAMETERS & AREA CALCULATION

If we straighten a cylinder or extract its curved surface and unroll it, we get a rectangle. Similarly, if we unroll the curved surface of its segment (Pirasos' floor surface here), we get a rectangle, but only with smaller length. The angle of each seal to seal region (which includes a Piraso in between) is 40°.

Length of each region between 2 atmospheric separation

Figure 2.2.1 Cross Section of Agricultural Truncated Torus

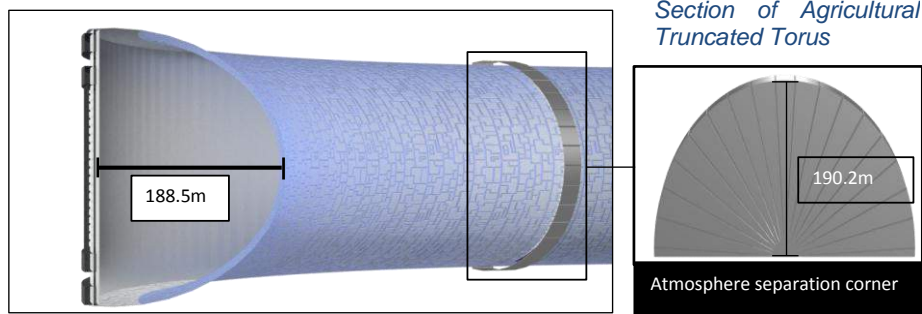

Figure 2.2.2 Agricultural Truncated Torus



corners(which includes a Piraso in between) = length of arc =  $\Theta / 360^\circ \times 2 \times \pi \times r =$   
 $40/360 \times 2 \times \pi \times 772$   
 $=538.95767\text{m}$   
 Width= 270 m, surface area =  $(538.95767 \times 270) \text{ m}^2 = 145518.57171427 \text{ m}^2$   
 The length of atmospheric separation corner is exactly 1/180<sup>th</sup> the total perimeter,  
 Length =  $1/180 \times 2 \pi \times r$   
 $=180 \times 2 \times \pi \times 772$   
 $= 26.94788356 \text{ m}$   
 Curved surface area =  $26.94788 \times 270 = 7275.9285612 \text{ m}^2$   
 Surface area of the region between 2 seals(total utilizable agricultural area) = (total area including belts - area of 2 belts) =  $145518.57171427\text{m}^2 - (2 \times 7275.9285612) = 130966.7146203$   
 Total agricultural area = area of each Piraso  $\times 9 = 1178700.4315827\text{m}^2$   
 (Approximately)

## Industrial Wave Structure

The industrial structure has been aptly named “waves structure”. Inspired from water waves, the industrial structure provides separate area for each industry. Transportation from one wave to another occurs through curved spokes located at the bottom of each wave. These also provide structural strength to the waves.

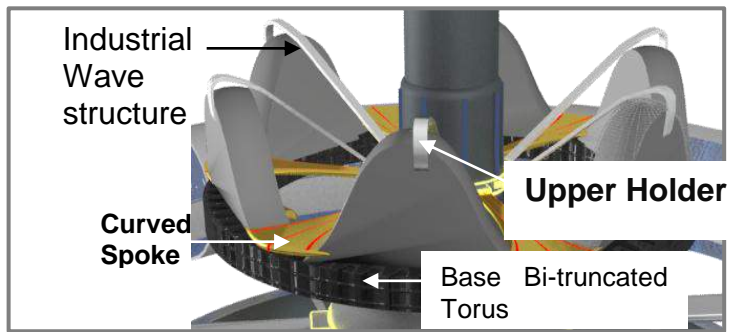

Figure 2.2.3 Industrial Wave Structure

The upper holders provide support in the upper ends. The base bi-truncated torus delivers an appropriate area to all industries and suitable location for the establishment of machines and monitoring devices.

## STRUCTURE PARAMETERS AND AREA CALCULATION

The industrial wave structure has been divided into a semicircle, a rectangle and 4 triangles. The total area was calculated to be **89601.286m<sup>2</sup>** per wave. Since there are 6 waves, total area provided by the waves structure =  $89601.286 \times 6 = 537607.716\text{m}^2$ .

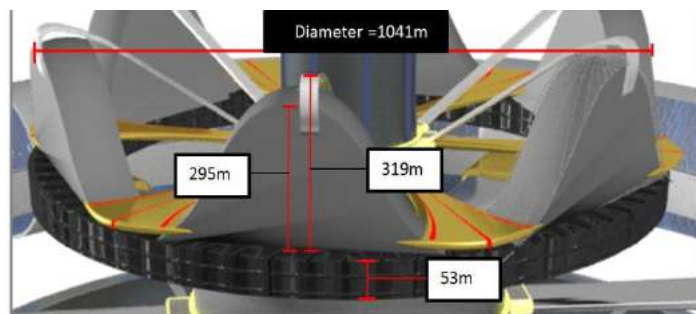
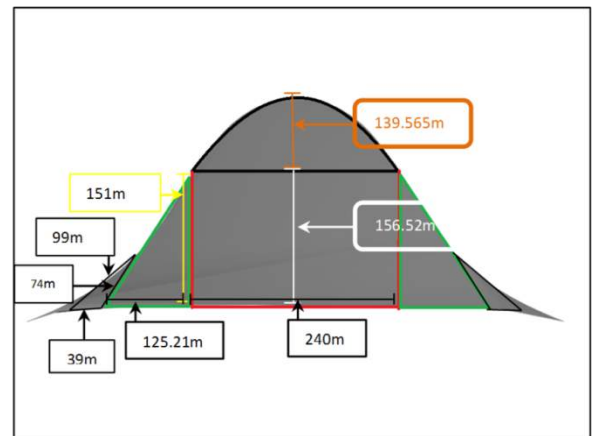

Figure 2.2.4 Dimensions of Industrial Wave Structure



### Recreational Centre

The recreational center serves numerous purposes. It offers a combined region for recreation and a discrete area for micro and zero g research. It has a curved monolithic design with no edges. It is hollowed from the inside to allow easy pressure maintenance and air management. The recreation center is also a very vital part of the structure as the attachment and rotation rings which rotate the residential hybrid torus are directly connected to it. It is divided internally into 3 parts. The middle part of the structure, to which the attachment and rotation rings are

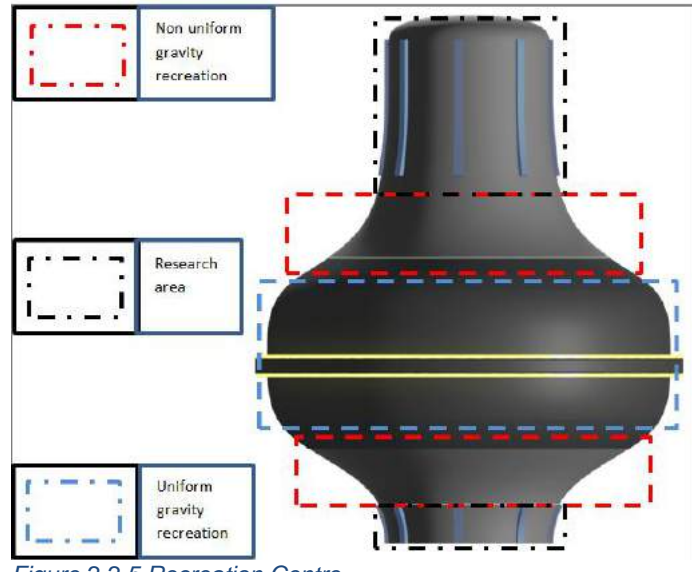

Figure 2.2.5 Recreation Centre

attached, is the uniform gravity recreation area due its cylindrical floor. There are two non-uniform gravity recreation areas which, due to their curved design and varied radii from the center, have gravity that decreases as we go towards the top. In addition to that there are 2 microgravity research areas.

#### STRUCTURAL PARAMETERS

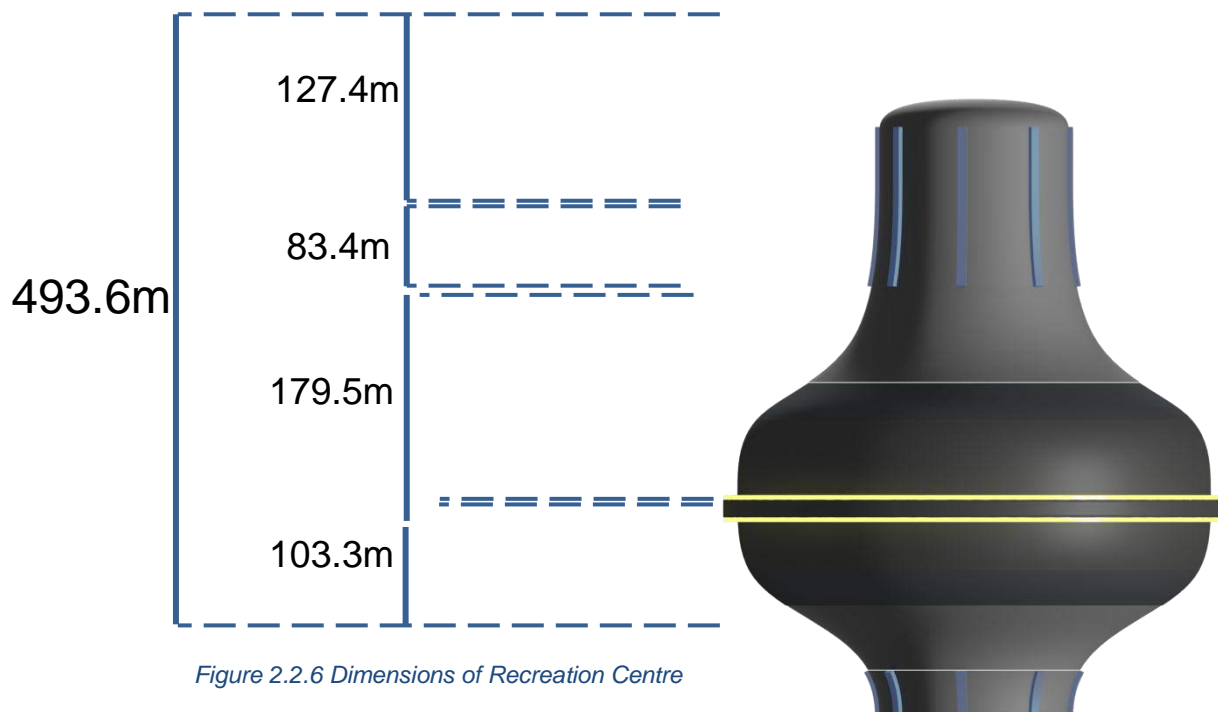

Figure 2.2.6 Dimensions of Recreation Centre

## Central Cylinder

The central cylinder is the pivotal component to which every other component's strength and stability depends. It balances the structure and upholds it. The central cylinder in VONA has a *radius of 178.64m and a height of 2190m*. It is a *non-rotating component so it has no gravity*. It is divided into several sections depending upon the requirements. It has vertically aligned transport corridors for vertical transportation. The central cylinder is basically a simple *cylinder with chamfered corners*. The difference between a simple cylinder and a chamfered cylinder is that a chamfered cylinder doesn't have corners. The lack of corners increases overall firmness of the structure.

## STRUCTURAL PARAMETERS

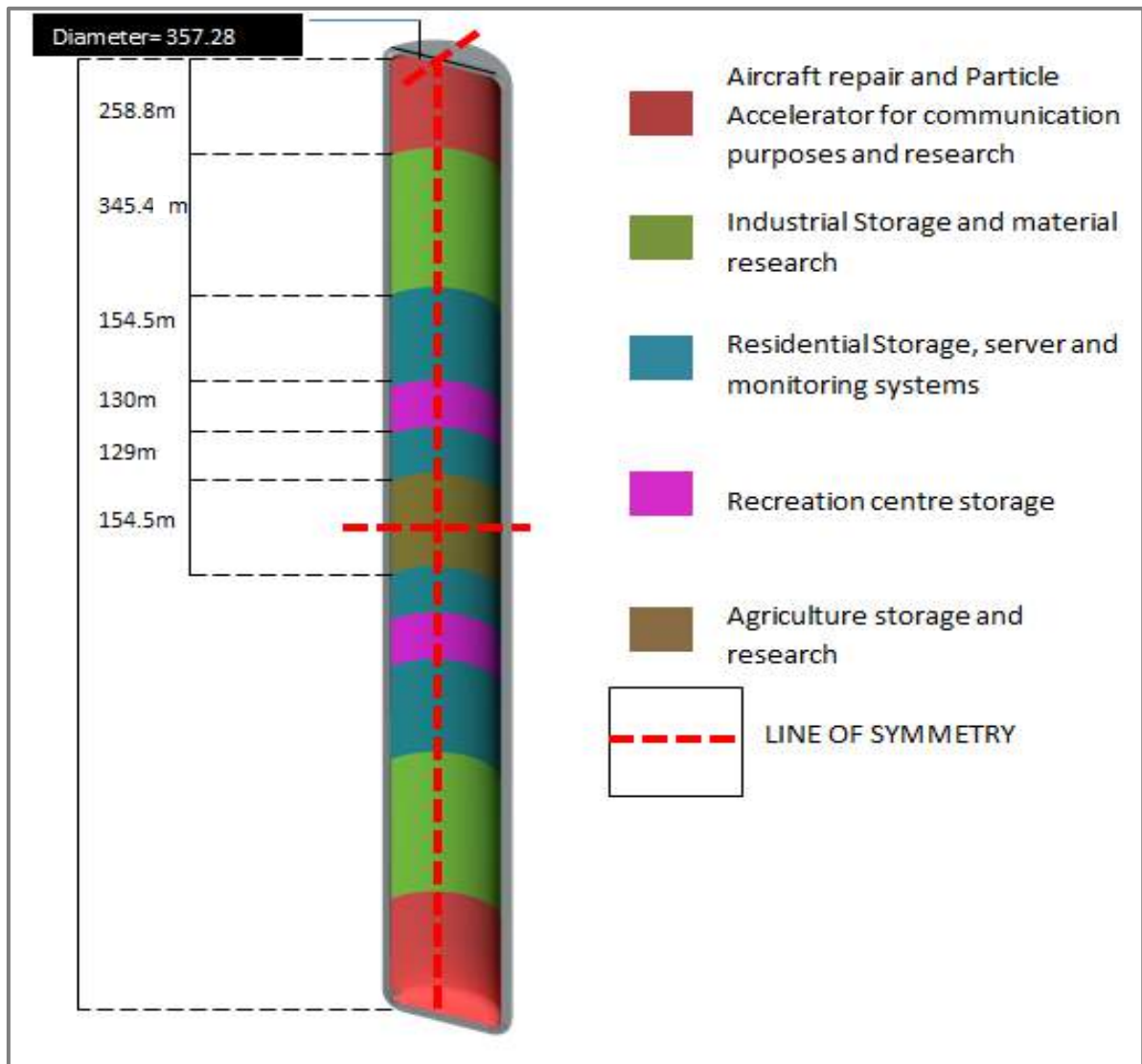

Figure 2.2.7 Dimensions of Central Cylinder

## Docking Facility

Docking port is the place where all the external activities including transportation and the import-export of goods, industrial machineries and other resources will take place. VONA has two docking ports lying at the extreme ends of the central cylinder. Each docking port has 4 inlets and 4 outlets.

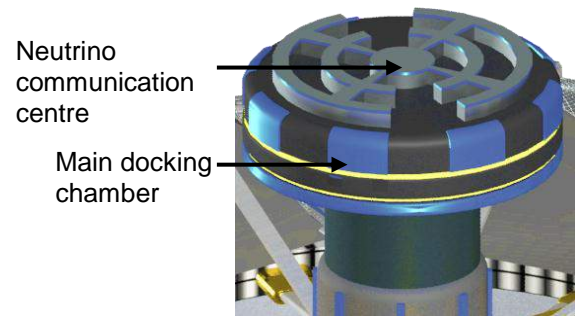

Figure 2.2.8 Docking Facility

## Main docking Chamber

The docking chamber inside the docking station has *length of 222m*; and has two *long runways each measuring 190m* in length and *51m* in width. It has Control Centre lying on the front wall at a *height of 60m*. There is a craft elevator at the end of the runway which will transport the planes to the maintenance center, a floor below the docking chamber, where aircraft repair, refueling etc. will be done.



Figure 10 Main Docking Chamber

## Maintenance Centre

Maintenance Centre of VONA is located at the bottom of docking station, below the docking chamber. Both the sections are connected to each other with the elevators located at one end of the runway. Maintenance Centre will provide the space-crafts with the repair, loading-unloading of goods and industrial machineries or the extracted minerals. Provision of bio-suits to passengers and pilots will also be done here.

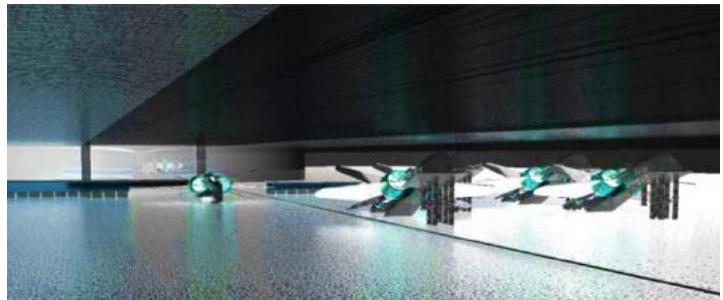

Figure 9 Maintenance Centre

## MINOR COMPONENTS

### Spokes and Connections

The spokes used in the structural design are of 3 types: Residential sector (design A), agriculture sector (design B) and industrial sector (design C) spokes

## SPOKE DESIGN A

The Design A spokes bond the residential hybrid torus to the recreation center. The Spoke design A has two types of attachment, the inner attachment which join them to the rotation ring-A and the outer attachment which connects them to the residential hybrid torus via clamps (holders)

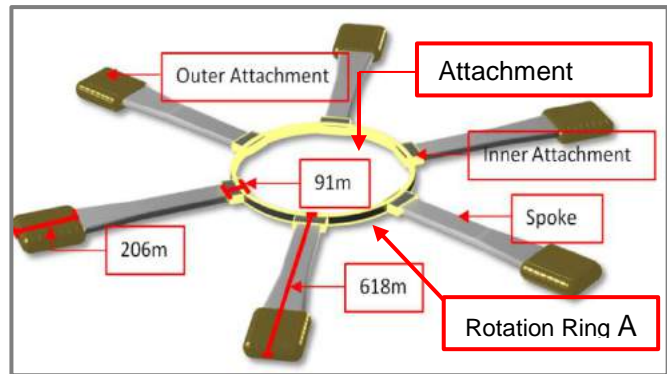

Figure 2.3.1 Spoke Design A

## SPOKE DESIGN B

The Design B Spokes are attached directly to the Atmospheric separation corners inside the agricultural truncated torus. The spoke Attachment joins them to the rotation ring B. The spoke locks, bolt the spokes to the rotation ring.

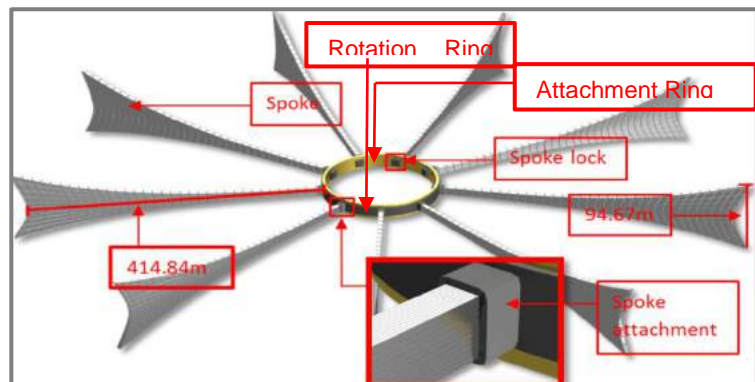

Figure 2.3.2 Spoke Design B

## SPOKE DESIGN C

The Design C spokes are attached to the industrial structure. They hold the waves together and provide structural support to them. Their design consists of two diverse holders: the flat spokes curved upper holders. The flat spokes grips the lower part of the waves on the sides, while the upper holders serve the function of holding the upper part of the waves. Both the upper holders and the spokes are attached to the rotation ring C by Spoke attachments.

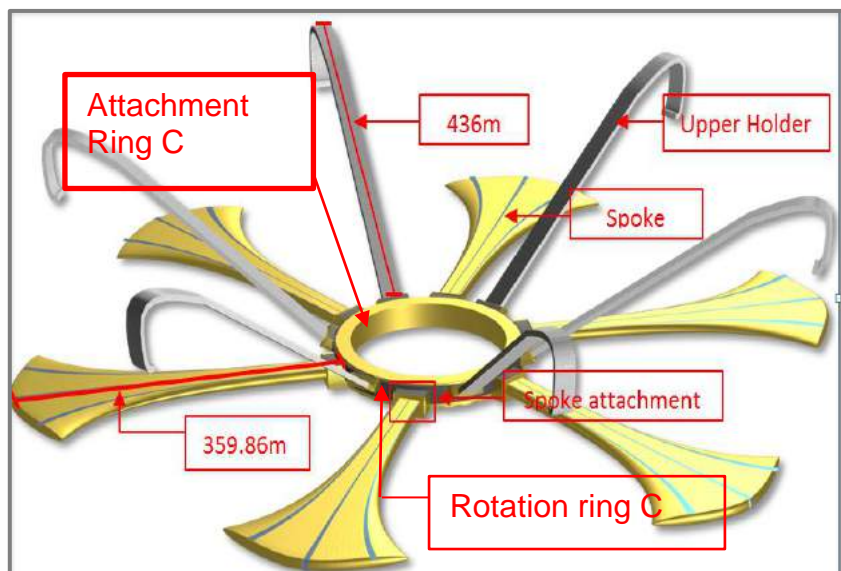
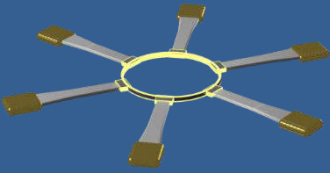
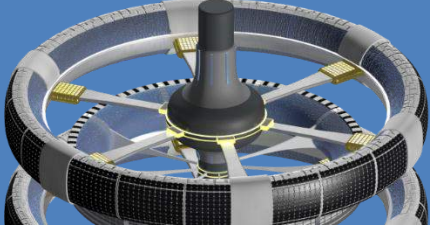
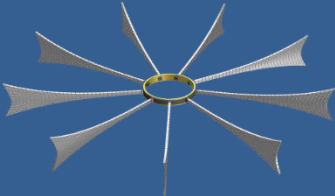
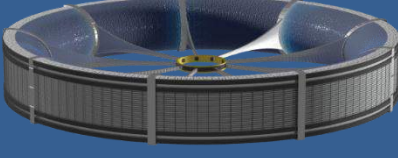
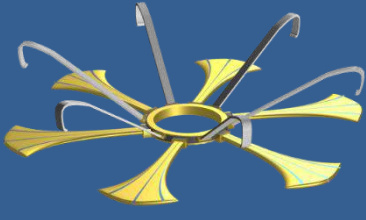
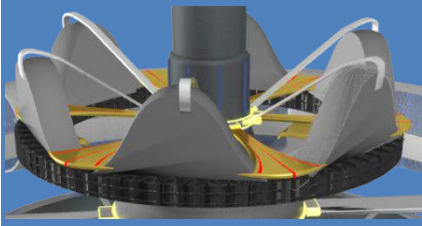

Figure 11 Spoke Design C

**Table 2.3.1 Summary of Spokes**

SPOKE DESIGN	LOCATION	PURPOSE
<p>SPOKE DESIGN A</p> 	<p>Residential Hybrid Torus</p> 	<p>Attaching Residential Hybrid torus to Rotation ring A</p>
<p>SPOKE DESIGN B</p> 	<p>Agricultural Truncated Torus</p> 	<p>Attaching Agricultural Truncated Torus to the Rotation ring B</p>
<p>SPOKE DESIGN C</p> 	<p>Industrial Wave Design</p> 	<p>Attaching Industrial Waves structure to the Rotation Ring C</p>

## ROTATION AND ATTACHMENT RINGS

The objective of attachment rings is simple: attaching spokes leading to the outer structural component (e.g.: the residential Hybrid torus, agricultural torus or the waves) to the inner structural component (central cylinder or the recreational center) via attachments. In figure 2.3.4, the ring seen in yellow is the attachment ring of the residential structure. Inside it, a black colored rotation ring is present, to which the spokes attached. The rotation ring rotates along with the outer structure that it is attached to. (e.g.: the residential combined torus). *The idea behind using of these attachment and rotation rings is that we can rotate any component of the structure to a desired rpm without distressing any other structural component.*

### Mechanism

The rotation and the attachment rings are not directly connected. The space between them is covered by ball bearings which roll along with the outer structure which moderates friction amid them. The Attachment ring remains stable while the rotation ring revolves.

To ease the friction, the attachment ring would be crusted with a layer of *Semi-*

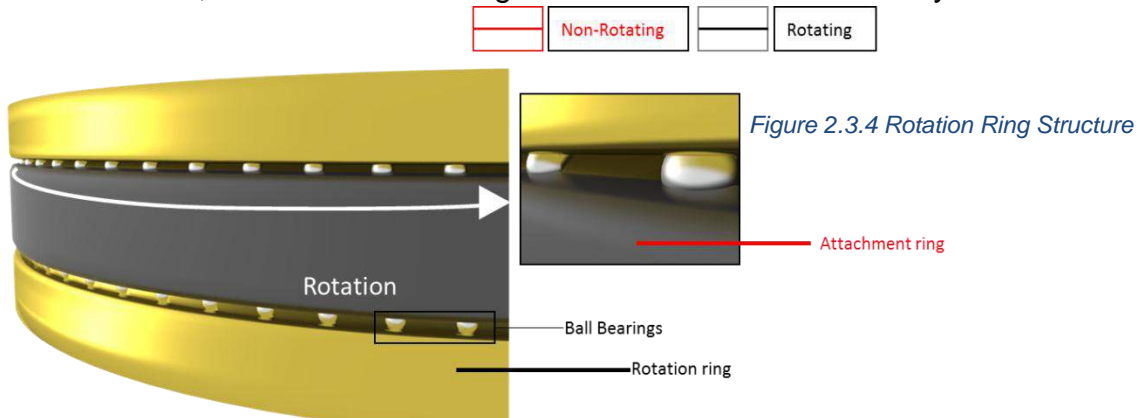

*fluorinated Stretched super aligned Polymer Overlapped Polystyrene Polydimethyl Siloxane Di-block Co-Polymer Monolayer* coated with *Tetra Fluoro-ethane*, creating a non-stick surface which would be 90% frictionless and on which the ball bearing would rotate, making oscillation process much simpler and easier.

### Attachment and Rotation Ring Design A

This objective of Connection rings (attachment & rotation ring) is used for rotating the residential HYBRID tori and for the industrial base bi truncated tori in each of the industrial waves. The spokes leading from the residential hybrid tori A & B are attached to their corresponding rotation ring Design A through inner spoke attachments. These rotation rings aid the rotation of residential tori and industrial base bi-truncated tori to generate pseudo gravity. The rotation will be maintained through solar electric propellers installed on the exterior of Clamps (holders). Both the Industrial Base's bi truncated torii are also rotated for gravity generation by the assistance of Design-A Rotation and attachment ring.

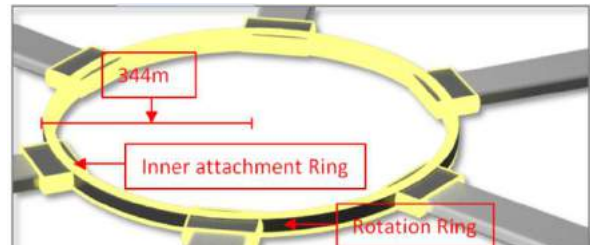

Figure 2.3.5 Attachment and Rotation Ring Design A

### Attachment and Rotation Ring Design B

The function of Design B attachment and rotation rings is that they rotate and support the agricultural truncated torus. The spokes leading to the exterior of the Piraso's atmospheric separation corners are attached to the rotation ring B and rotate along it.

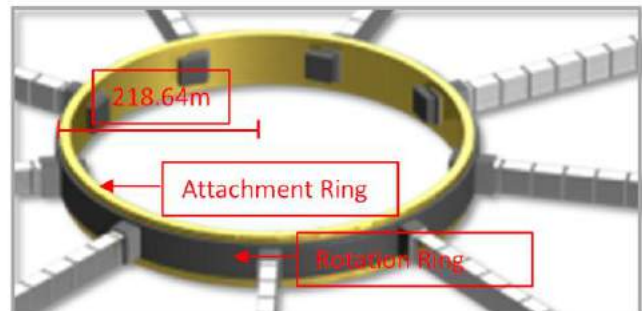

Figure 2.3.6 Attachment and Rotation Ring Design B

### Attachment and Rotation Ring C

The type C Attachment and rotation rings are utilized for the rotation of the industrial wave structure. Note that the attachment and rotation ring C (for the waves structure) and Attachment And rotation Ring-A (along the base bi truncated tori) are in synchronization such that they rotate at equal

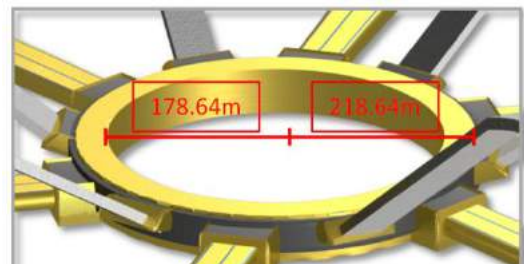
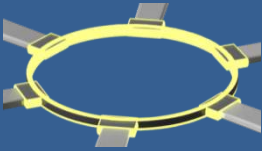
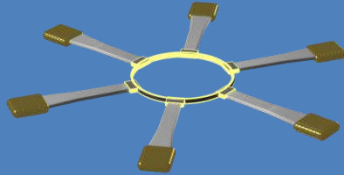

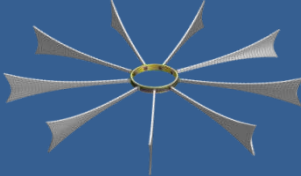
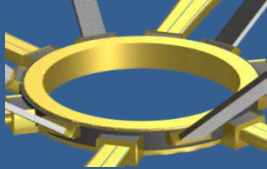
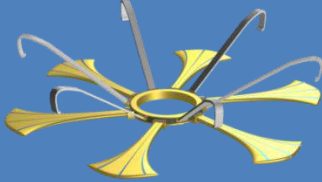

Figure 2.3.7 Attachment and Rotation Ring Design C

speed. Also, they are attached internally using beams such that they make a whole industrial structure that rotates uniformly.

## LOCATION AND PURPOSE OF ATTACHMENT AND ROTATION RINGS

Attachment and rotation ring	Location	Purpose
Attachment and rotation Ring A 	SPOKE DESIGN A 	Rotation of the residential hybrid torus Rotation of Industrial Base Bi truncated torus.
Attachment And Rotation Ring B 	SPOKE DESIGN B 	Rotation of Agricultural Truncated Torus
Attachment And Rotation Ring C 	SPOKE DESIGN C 	Rotation of industrial Structure.

## SECTION 2.0 STRUCTURAL OVERVIEW

## CH. 2.4 SYMMETRY & DIMENSIONS

### Top View Dimensions

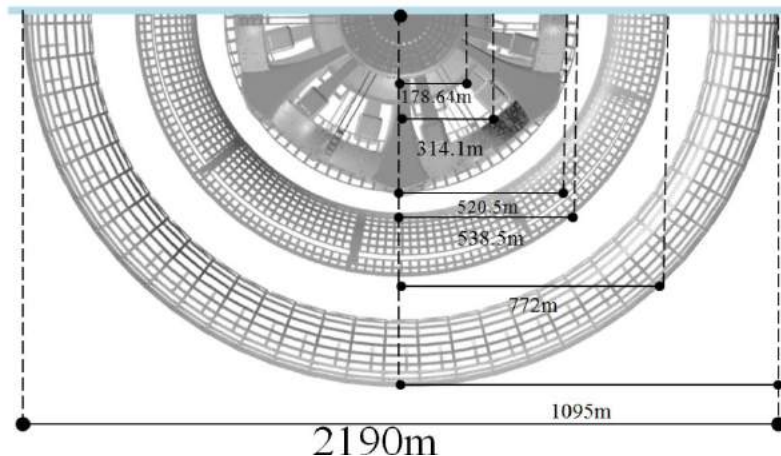
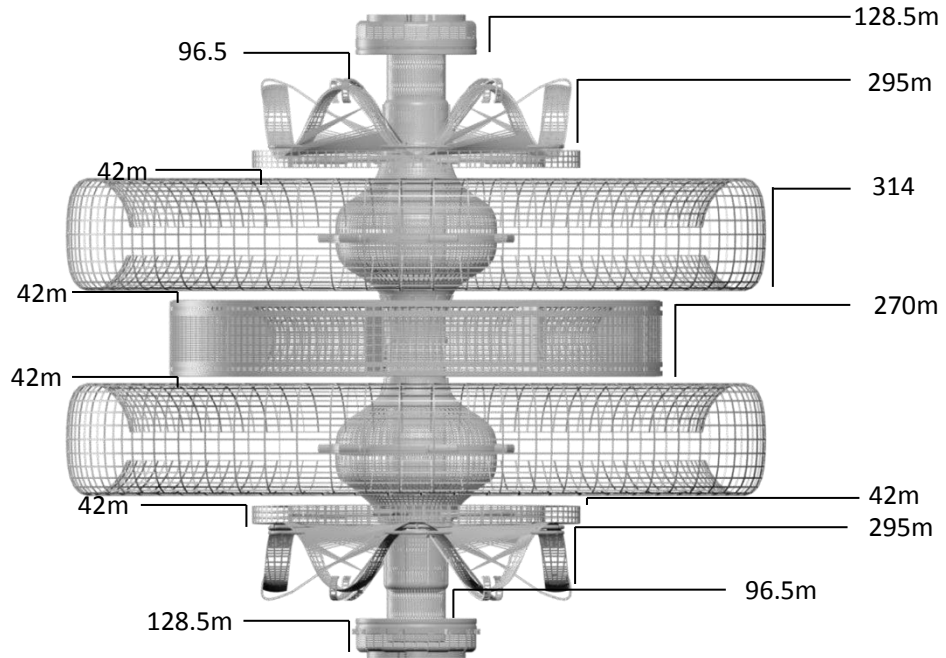

Figure 2.4.1 Top view dimensions



## Front View Dimensions

Figure 2.4.2 Front view dimensions



COMPONENT	RADIUS(FROM CENTRE)	VERTICAL CLEARANCE	VERTICAL GROUND WIDTH	TOTAL GROUND WIDTH	TOTAL AREA (Utilizable)
Residential CT	1095m	179.508m	314m	354m	2086944m <sup>2</sup>
Agriculture TORUS	772m	188.483m	295m	295m	1178482.5m <sup>2</sup>
Recreation semi sphere	314.1m	628.2m	772.77m	772.77m	721313m <sup>2</sup>
Central Cylinder	178.64m	357m	1920m	1920m	2155929.6m <sup>2</sup>
Industrial Waves	520.5m	125.63m	270m	270m	537607.716m <sup>2</sup>
Industrial Base Torus	538.5m	167m	42m	42m	179397m <sup>2</sup>
Docking station	246.37m	128.5m	492.74m	492.74m	190688.947m <sup>2</sup>

## Symmetry

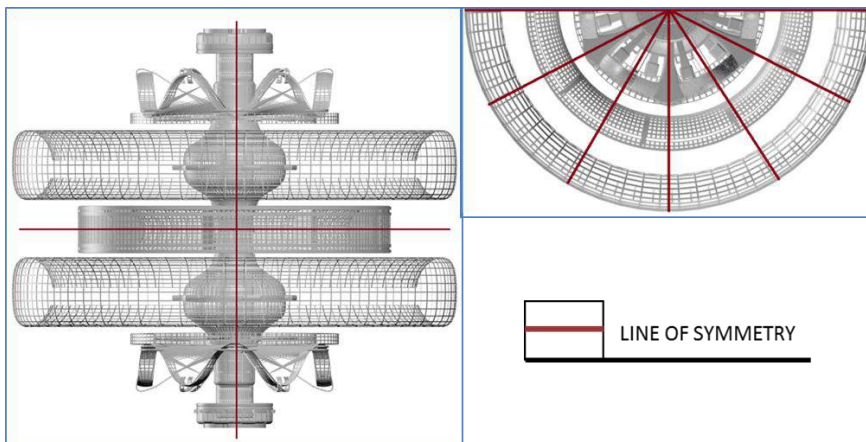

Figure 2.4.4 Front view and top-view dimensions

## CONSTRUCTION MATERIALS

### BIOMIMETIC MATERIALS

Human endeavor inspired by mother-nature can produce marvels. Biomimetic materials are a result of such human effort. The word biomimetic is derived from “Bio” related to biological i.e. natural living things and “mimetic” meaning imitating. Bio mimetic materials are artificial materials which mimic the properties of natural materials.

The biomimetic materials used in VONA have been inspired from some of the unique natural structures:

#### Abalone Shell Tiling

The abalone shell is one of the toughest shells in nature. Its toughness comes from bumps on its surface called Nano asperities. There are 3 types of Nano-asperities in an abalone shell. These are named:

- TYPE-A
- TYPE-B
- TYPE-C

##### 1. Type A or the Major Meso-layer

The most common Nano-asperity found in abalone shells, consists of dome shaped structures which are arranged in such a pattern that if one dome has a larger radius the opposite dome will have a smaller radius. This type of arrangement increases the stiffness of the structure.

##### 2. Type B or the Minor Meso-layer

Asperity has structure which consists of 2 interlinking polygons. This type of arrangement increases the tensile strength of the material.

##### 3. Type C or Nano fibers

It is made entirely out of highly elastic Nano-scale natural fibers. This type of arrangement bonds 2 layers of abalone shell tiling together and does not allow them to break away from each other.

### Spider Silk Fibers

The Spider Silk Structure is one of the strongest fibres found in nature. Its strength comes from its structure, instead of the materials (Proteins) it is made from.

Figure 2.5.1 Abalone Shell

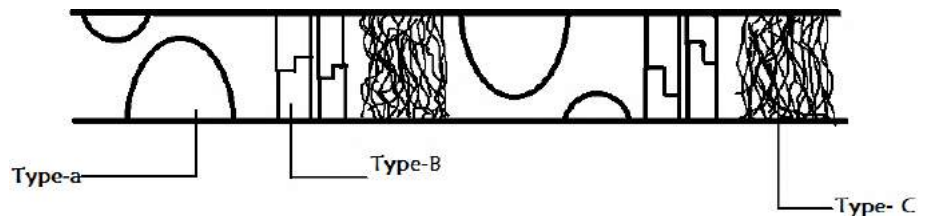

Figure 2.5.2 spider silk fibers

Its structure consists of Main Fibres and Fibre joints (joining long main fibres), forming a Fibre system, each of which is held together by Structural Joints. By using this structural configuration, we assigned sub materials to structural sub components and theoretically created a material called “The Aragog Spider Silk composite”.

**Table 2.5.1 Specifications of Aragog Spider Silk composite.**

Sub component	Material assigned	Tensile strength
Main Fibres	Toray TG1000G, Carbon Fibre and Vectran	>308GPa
Fibre joints	Carbon Nanotube based super rubber	
Structural joints	RTV adhesive and Cyanoacrylate adhesive	

## Impenetrable Composite

Incorporating the features of spider silk structure and abalone shell, we designed a material that we call **Impenetrable Composite** (or The **IPC**). The IPC, with a tensile strength of 1450 GPa and extraordinary toughness is perfect for components that form the vital parts of the structural design such as the central cylinder, residential hybrid torus, and industrial waves design.

**Table 2.5.2 Specifications of Impenetrable Composite**

Component	Sub Materials	Tensile Strength
1. Major Meso-layer [TYPE A]	1. Body Centric Cubic Carbon(BCC)	1450GPa (theoretical)
2. Minor Meso-layer [TYPE B]	2. Boron Nitride Nanotube and Micro-Melt® 10 Tough Treated Tool Steel	
3. Entangled Fibers [TYPE C]	3. Aragog Spider Silk Composite	
4. Hexagonal tile. [BASE AND TOP]	4. Graphene	

## Gecko-Feet Adhesive Pattern

Gecko feet are considered to be the stickiest feet with exceptionally strong bonding mechanism. The gecko feet adhesive pattern can be used to create an adhesive material that would stick various layers of material tiles and bind them together.

*Figure 2.5.3 Gecko-Feet Adhesive*

## Sticko-Gecko Composite

Assigning different materials to this type of tiling we have created a material named “Sticko-gecko Composite”. It possesses incredible adhesion properties. A quarter inch of the stick gecko composite can stick a 671 Kg Iron piece vertically to a wall.

**Table 2.5.3 Configuration of Stickle Gecko composite**

Component	Sub-Materials	Salient Features	Tensile Strength
1. Below Surface [A]	1. The Below surface will be made out of Polyben Zoxazole	1. This type of tiling is the stickiest because of its Nano fibers and Nano asperities which make it sticky enough to hold thousands of pounds on a smooth wall. 2. Extreme temperature resistance of the adhesive allows it to tolerate micrometeorite collisions without losing adhesion properties.	> 17.52 GPa
2. Grappling Fibers [B]	2. The grappling Fibers will be made out of UHMWPE Fibers which will be coated with Anaerobic Adhesive		
3. Small Nano end gripper Fibers.[C]	3. The Nano end gripper fibers will be made out of Silica Glass Optic Strands and coated with Dimethylthiotoluenediamine		

### Shark Scales Anti-Bacterial Pattern

*Figure 2.5.4 Shark Scale Pattern*

The shark skin has numerous minute and non-uniform asperities on it, and since ages has completely prevented microbial growth. This is because the bacteria need flat surfaces to form biofilms or colonies.

#### Bacillus Destructor

Inspired by this unique characteristic of shark skin, we designed a material with Nano asperities to inhibit microbial growth on its surface and named it The Bacillus destructor material. This material can be entirely created out of mono-crystalline silicon and has a tensile strength >10 GPa

### Lotus Leaf Super Hydrophobic Pattern

A waxed Lotus Leaf has an enhanced structural property which helps it to stay water resistant or hydrophobic. This is not just due to the waxed surface, but because of the microscopic sprouts present on the surface of the lotus leaf. These sprouts help in preventing the water (even dust and Mud) from staying on the surface of the material for absorption.

*Figure 2.5.5 Lotus Leaf Super Hydrophobic Pattern*

#### Lotus leaf inspired water ghost material

Using the lotus leaf hydrophobic pattern, we designed a material using stretched super aligned carbon nanotube array, silicon carbide and titanium carbide. Carbon Nanotube array itself is a very water resistant material that prevents water absorption. The result was a 99% hydrophobic material.

**Table 2.5.4 Lotus leaf Water ghost material specifications**

Component	material	Tensile strength
Sprouts	Silicon Carbide, Titanium Carbide	280 GPa
Floor	Stretched Super Aligned Carbon Nanotube Array	

Total Raw\* Materials Used

**Table 2.5.5 List of raw materials used inside VONA**

Material name	Ultimate Tensile Strength and Thickness
BCC	>812GPa and <988Gpa
Stretched Super Aligned Carbon Nanotube Array	>325 GPa
Graphene	>130 GPa
Boron Nitride Nanotube	>33 GPa
UHMWPE Fibers	>3.5 GPa [Fiber Alone]
Silicon Carbide	>3.44 GPa
Micro-Melt® Tough Treated Tool Steel	>5.25 GPa
Polystyrene-Polydimethyl-Siloxane- Di-block copolymer	>10-50 GPa
Titanium- 11	>1.5 GPa
Boron Nitride Nanotube	>33 GPa
Mono Crystalline Silicon	>7 GPa
Tungsten	>1.51 GPa
Polyben Zoxazole	>5.7 GPa
RXF1	>1.7 GPa
Aggregated Silica Aerogel	> 24 MPa
Diamond Aerogel	>20 GPa
Titanium Carbide	>60 GPa
Lunar Soil or Super Adobe	> 2.7 GPa
Carbon Nanotube Based Super Rubber	> 60 GPa
Palladium Based Metallic Glass	>20 GPa
Vectran	>3.34 GPa [Fiber Alone]
Lead Glass	>
PICA- X	> 10 GPa
Silica Glass Optic Strands	>4.1 GPa
Reinforced Carbon	> 2 GPa
Nafion	N/A: not available in single layer, broken into chunks just like soil
Amorphous silica particles	N/A: used in minimal quantities for refractive index matching, not used in layers.

### Tiling of VONA

The materials used in VONA cannot be monolithic i.e., a single and uniform layer of materials cannot be used for construction of components of the structure which themselves are enormous in size. Therefore, Tiles of materials would be constructed and then frame made up of Titanium-11 would be used to bond them together to form a large layer of tiles of that material. Several layers of tiles would gradually be constructed and then connected together using titanium frame.

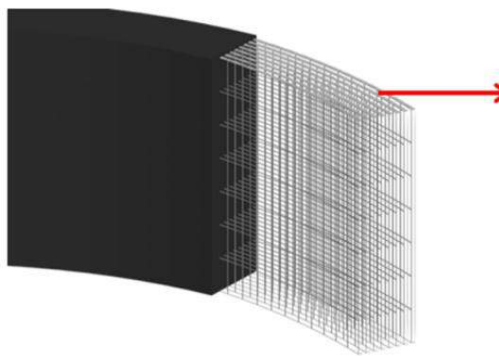

Figure 2.5.6 Construction of frame

TITANIUM-11  
FRAMEWORK

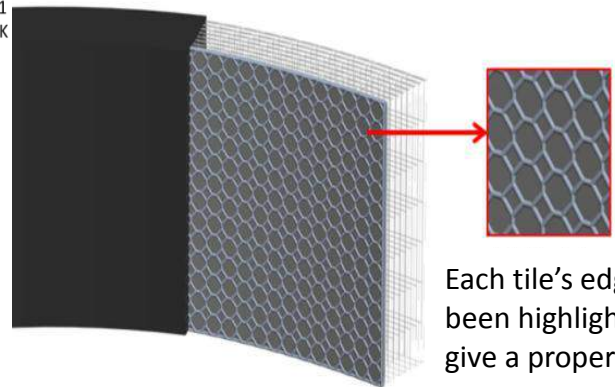

Figure 2.5.7 Insertion of First tile

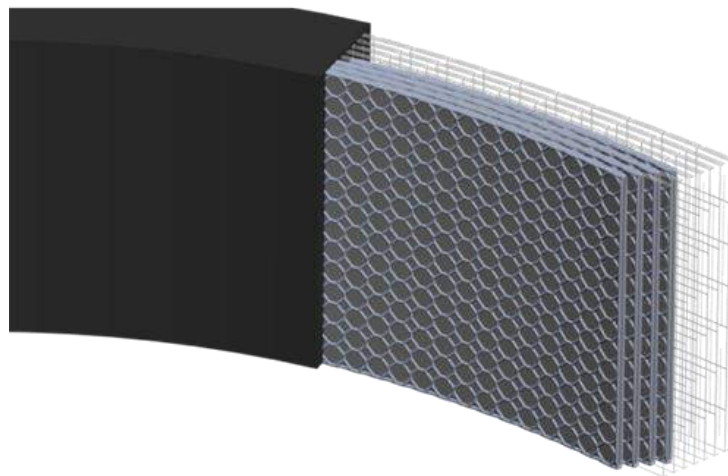

Figure 2.5.8 Insertion of Subsequent Tiles

## Construction Sequence and material application

### Phase 1: Central Cylinder

The First Phase of VONA would involve the construction of the most integral part of the structure: The central Cylinder. The construction would start from the base of the cylinder. 2 rings would be constructed using Impenetrable Composite (IPC) and then beams of IPC; Coated with polystyrene dimethyl Siloxane di-block co-polymer would be welded into the 2 rings. Polystyrene Dimethyl Siloxane Di-block co-polymer provides protection against micro-meteorites. Another ring would be constructed and welding would be carried out, and this process would continue.

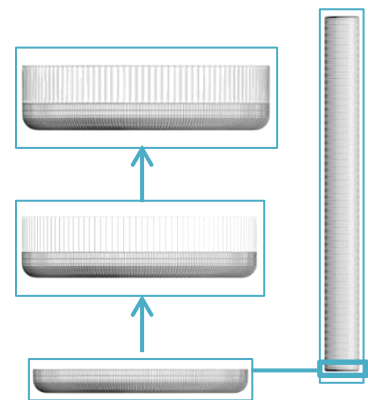

Figure 2.5.9 Process of construction of central Cylinder frame

### PHASE 2: CENTRAL HUB, SPOKES AND DOCK

#### STEP 1

The first step in the Phase 2 of VONA would involve the conclusion of central hub and construction of frame of recreational and research hubs. The construction method would be as same as that of the central cylinder.

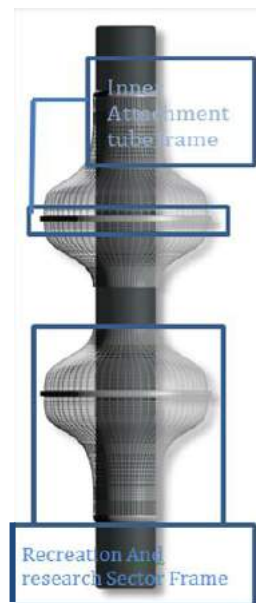
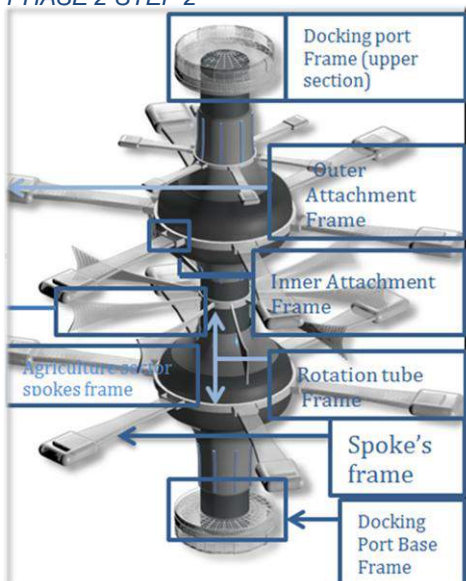

Figure 2.5.10: Completion of Central Cylinder & Construction of Recreation Centre Frame PHASE 2 STEP 1

Figure 2.5.11 Completion of Recreation Centre and Construction of Spokes' frame. PHASE 2 STEP 2



#### STEP 2

In the second step, construction of recreation centres would be completed. Then the frame of the spokes along with the attachments would be constructed. Simultaneously, the frame of the rotation and attachment rings would be constructed.

### PHASE 3: RESIDENTIAL AND AGRICULTURAL STRUCTURES

#### STEP 1

This would involve construction of the attachment ring (which connects spokes with the clamps or holders). Then the Holders would be constructed followed by the construction of frame of outer

section of residential semi-truncated torus.

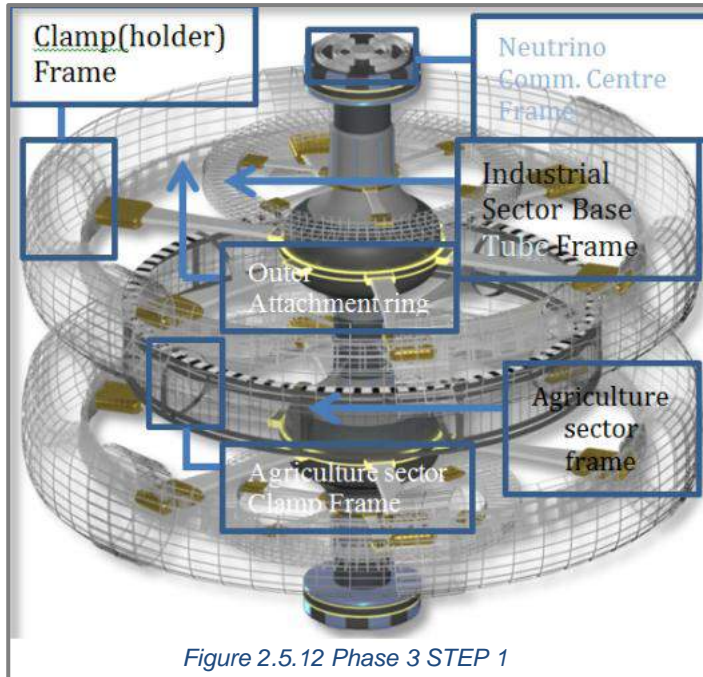

Figure 2.5.12 Phase 3 STEP 1

by the completion of agriculture sector (Construction of atmospheric separation centres and radiation protected illumination roof) would be carried out.

Simultaneously, the rotation ring of waves structure (connected internally with the rotation ring of base tube), along with completion of neutrino comm. Centre would also be done.

### Materials (PHASE 2 & 3)

Outer surface of the main residential torus will be made out of Titanium Lattice and Polystyrene-Polydimethyl-Siloxane-Di-block copolymer which will act as a micro meteorite protection unit. Below it the IPC tiling will be used followed by PICA-X (heat protection), Carbon Nanotube Based Super Rubber (for shock absorption), Titanium Carbide and Mono-crystalline Silicon Carbide.

Simultaneously, the Frame of agriculture sector involving semi-circular clamps which would later become a part (roof) of atmospheric separation centres.

### STEP 2

Completion of the residential sector (construction of floor (base) and radiation protected illumination windows); followed

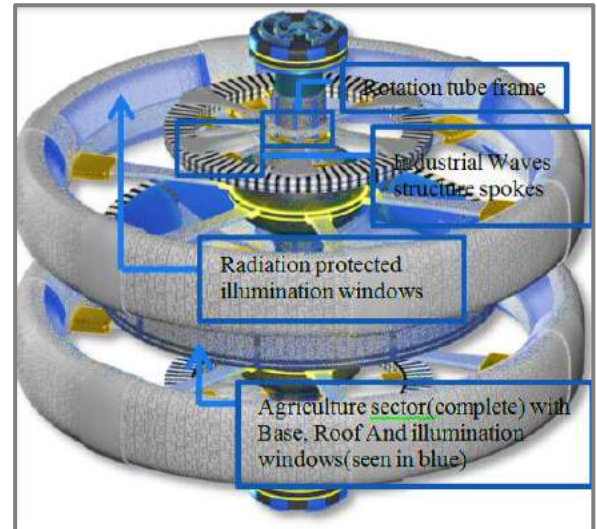

Figure 2.5.13 PHASE 3 STEP 2



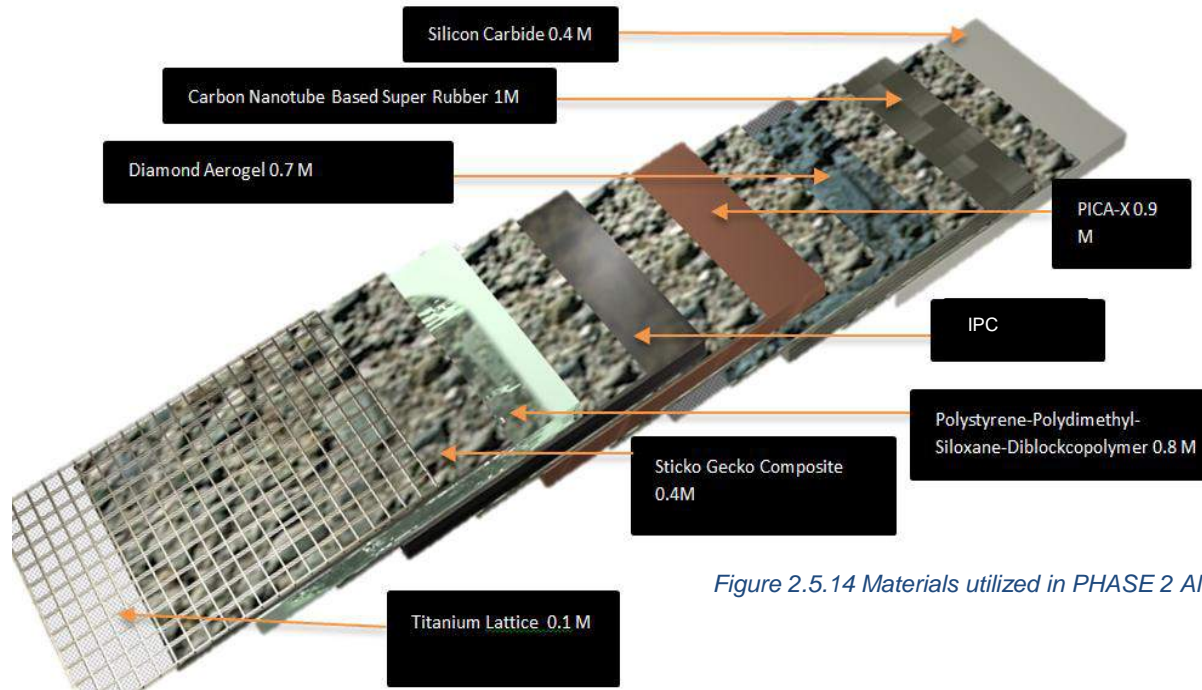

Figure 2.5.14 Materials utilized in PHASE 2 AND 3

## PHASE 4: APPLICATION OF SOLAR PANELS AND COMPLETION OF WAVES STRUCTURE

### Step 1

The first step would involve the laying out of Hyper EX solar panels (Quantum dots made of Vertically Aligned Carbon Nanotubes) Hybrid solar panels (efficiency>99 %).

Simultaneously, the frame of the industrial wave structures would also be constructed.

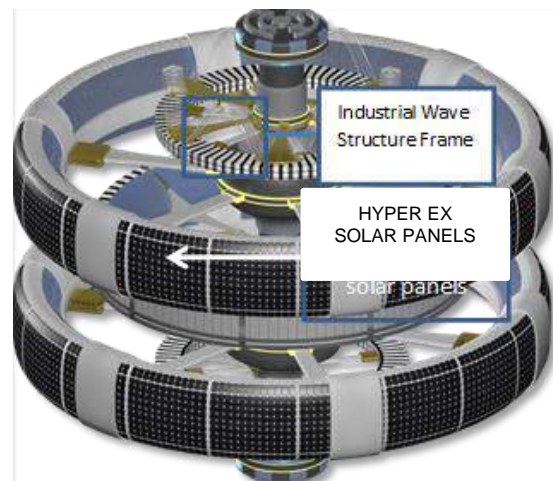

Figure 2.5.15 PHASE 4 STEP 1

## PHASE 5: FINAL CONSTRUCTIONS

The final phase of VONA construction would involve the conclusion of industrial wave structures, complete construction of Hybrid solar panels, integrations of electrical systems, and the internal completion of docking port, floor agriculture layout, the construction of metro trains and completion of transport corridors and applying of shielding materials outside the entire structure.

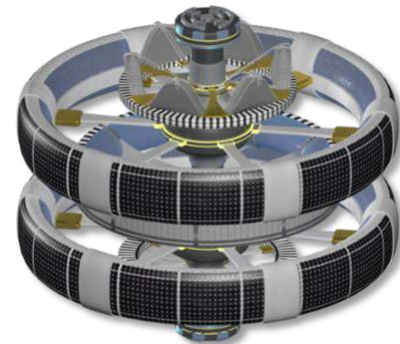

Figure 2.5.16 PHASE 5

**Materials (PHASE 5)**

Finals constructions done internally, materials of minor inner constructions discussed throughout the document depending upon the section.

## SECTION 2.0 STRUCTURAL OVERVIEW

## CH.2.6 INTERNAL STRUCTURE

**FLOOR MAPPING, LAYOUT AND MATERIAL APPLICATION**

## RESIDENTIAL HYBRID TORUS

## FLOOR STRUCTURE

The floor consists of 2 transport corridors and 1 residential corridor. The transport corridors are slanted to utilize maximum space. The residential corridors encompass the main area where settlers will reside. *The ground width of residential corridors is 254m.* The transportation corridors have a slanting

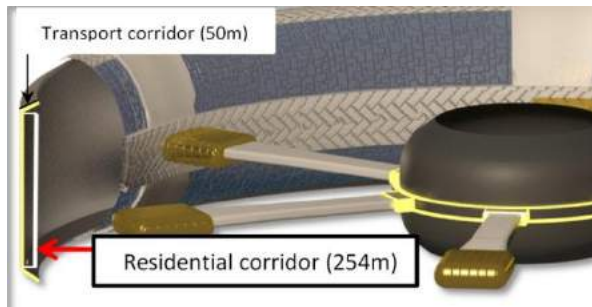

Figure 2.6.2 Structural Parameters of Floor of Residential HYBRID torus.

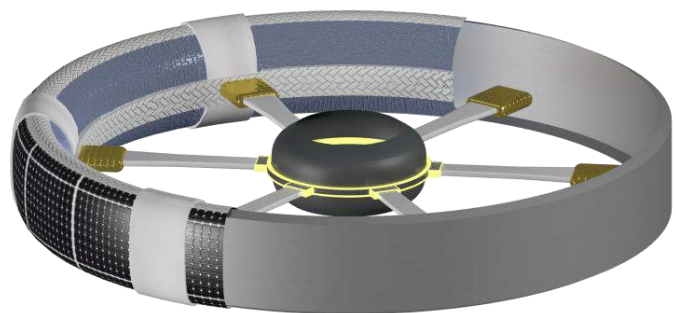

Figure 2.6.1 Residential HYBRID Torus sliced to show the floor

*ground width of 50m and vertical height of 30m.* Out of 50m, 20m have been utilized for transportation and 30m have been utilized for minor agriculture (herbs and medicinal crops).

**MATERIALS****Nafion**

Nafion is a *Sulphonated Tetrafluoroethylene based Fluoropolymer-copolymer*, which was first discovered in 1960s by Walther Gront. It is often used in fuel cells and batteries. Once micro-pellets are constructed out of this material, it can very closely mimic the actual earth's soil.

**Polystyrene Polydimethyl Siloxane Di-block Co-Polymer:**

Originally developed as a bulletproof material, this polymer can be used in the floor for sealing the beams that form the foundation of houses. When an object is launched at a high velocity towards the polymer, it melts, its particles scatter, and the object enters it, but never gets out. In addition to that, this material also completely seals the entry way of the penetrating object, completely absorbing its shock. The material also has the ability to regenerate to its original shape and size.

**Ethoxylated Non-Phenol Based Adhesive:**

It is a hot-melt adhesive which becomes stiff below 60° C. Heated to above 60°C; it can easily be applied to beams (for the foundation of houses) which can then be placed into the floor.

**Amorphous silica particles:**

Amorphous silica is a material often used for refractive index matching. Often materials which are mixed together, but have different refractive indexes do not allow observation. Some materials, called the refractive index matchers equalize their refractive index by increasing the refractive index of one of them after being placed in front of it. Amorphous Silica is such a material.

Now these were the materials that would be used for laying the foundation of

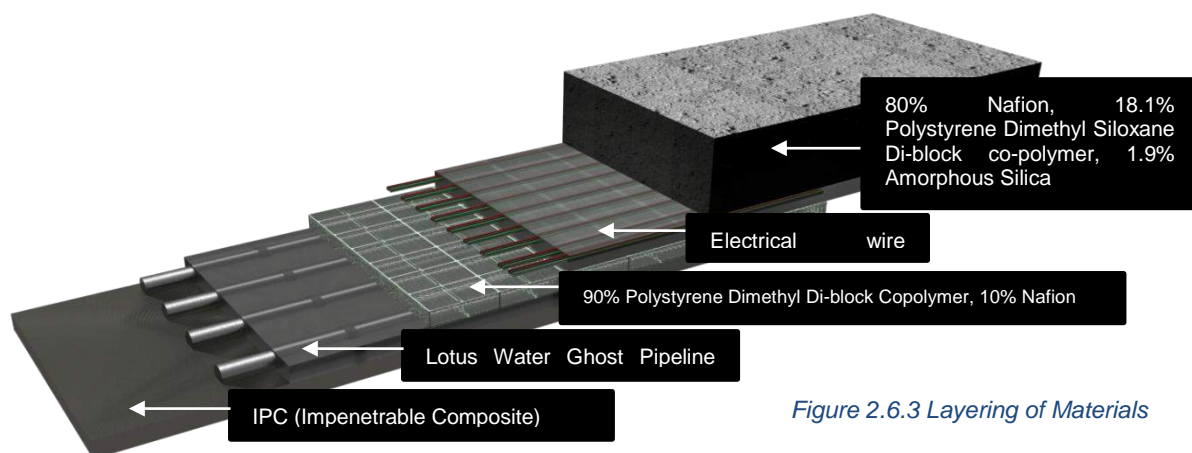

Figure 2.6.3 Layering of Materials

buildings. However the total materials utilized inside the floor would include:

IPC for the lowermost layer. The layer above it will be formed out of Lotus Water Ghost Water Pipes which will act as the water pipeline system in the tori. The third layer will be made out of 90% Polystyrene-Polydimethyl-Siloxane-Di-block copolymer and the remaining 10% will be of Nafion. The next layer will be the Electric Wires system. The topmost layer will comprise the upper section of the floor, constructed out of 80% Nafion 18.1% Polystyrene-Polydimethyl-Siloxane-Di-block copolymer and 1.9% amorphous silica particles.

## TECHNIQUE FOR CONSTRUCTION OF FOUNDATION OF BUILDINGS ON THE FLOOR

### STEP 1

First a beam which will comprise the foundation of the building will be constructed. Each beam will be dipped in Ethoxylated Non-Phenol Based Adhesive heated to about 60°C. Ethoxylated Non Phenol Based

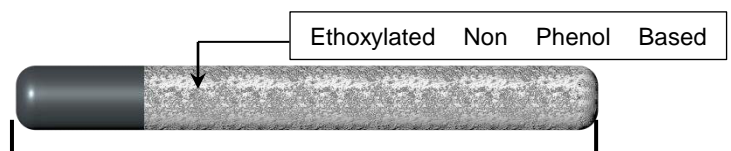

Figure 2.6.4 Ethoxylated non Phenol Based Adhesive Applied on the foundation beam

Adhesive is a hot melt adhesive which loses its adhesive abilities at temperature above 60°C making it the appropriate adhesive here.

## STEP 2

First a deep pit (a little smaller than the length of the beam) would be dug in the upper section of the floor consisting (Care will be taken to dig the pit such that its mouth on the exterior surface is much bigger). Nafion like soil is easily penetrable, allowing us to dig deep holes within the floor for placing beams that

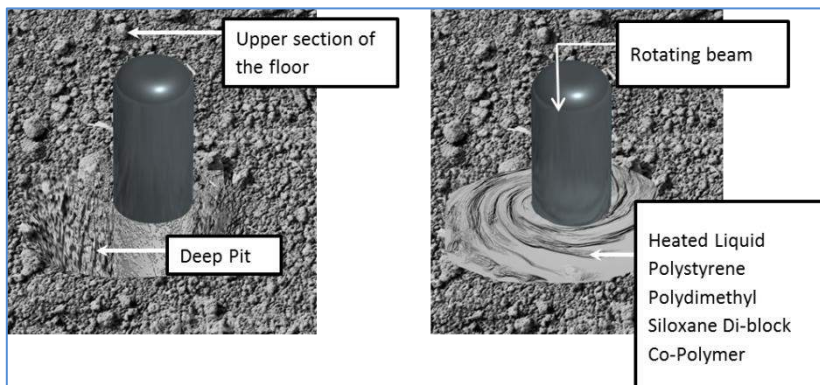

Figure 2.6.5 (a) Foundation beam placed inside deep pit  
(b) Rotating beam after pouring Liquid Polystyrene Dimethyl Siloxane Di-block co-polymer

comprise the foundation base of any building. Polystyrene Polydimethyl Siloxane Di-block Co-Polymer, although much less penetrable has the ability to seal an object from the outside. After the hole has been dug out, the beam will immediately be inserted along with Ethoxylated Non-Phenol based adhesive inside the floor. Highly heated liquid Polystyrene Polydimethyl Siloxane Di-block Co-Polymer will be poured and the beam will be rotated. Simultaneously, the co-polymer will be cooled so that it forms a seal on the beam. Here the work of the adhesive comes into play; it will keep the seal formed by the co-polymer intact.



## STEP 3

Step 3 involves repetition of step 1 and 2 to construct several beams dug in and sealed in the upper section of the floor. Over which a sturdy base coated with heated Ethoxylated Non-Phenol Based Adhesive heated to 60°C. This will firmly fix it to the floor. Then a single layer of Polystyrene Polydimethyl Siloxane Di-Block Co-Polymer will be poured over this which will fuse with the upper section of the floor and seal this base making it nearly impossible to break shock or disturb, all in all increasing its overall strength, sturdiness and power by leaps and bounds.

## FLOOR LAYOUT AND DIVISION OF COLONIES



Figure 2.6.7 Division of colonies within Residential HYBRID torus

LEGEND	
	Common Zones 150m
	Colonies 3290.04 m

Each residential hybrid torus is divided into 2 colonies.

Each colony covers a length of 3290.043955 m with a height of 254 m residing 4061 people each. So the total area is 835671.176 m<sup>2</sup>. The two colonies will have all the

basic necessities present like clinics, gymnasiums and some life support systems including the inhabited colonies. Between each end of the two colonies will be a sector named as the “Common Zone” of length 150 m forming an area of 38100 m<sup>2</sup>. The common zone will have schools/universities, storage area, multispecialty hospitals, different communication systems, graveyards etc. The area provided to each person in the colony is 210 m<sup>2</sup> while the area on each of the 2 common is 18 m<sup>2</sup> per person. The following table shows the area allotment of the colonies and sectors of each residential area

**Table 2.6.1 Area allocation inside Residential Hybrid Torus**

Criteria	Area m <sup>2</sup> /person	Ground provision	Percentage
Banks	2.008824519	8356.71	1
Community Halls	4.017649038	16713.42	2
Fire Stations	2.008824519	8356.71	1
Gymnasium	14.06177404	58496.98	7
Holy Places	10.0441226	41783.55	5
Hospitals	10.0441226	41783.55	5
Life Support Zone	16.07059856	66853.69	8
Markets	12.05294712	50140.26	6
Parks & Ponds	12.05294712	50140.26	6
Residential Colonies	60.26474519	250701.34	30
Green Cover	10.0441226	41783.55	5
Trees and Bushes	4.017649038	16713.42	2
Vacant Area for Future Expansion	34.15002163	142064.09	17
Walking areas and footpaths(Transportation)	10.0441226	41783.55	5
<b>Total</b>	<b>200.8824712</b>	<b>835671.08</b>	<b>100</b>

The area allotment in two common zones is as follows

**Table 2.6.2 Area allocation per person in Residential colonies**

Criteria	Area m <sup>2</sup> /person	Ground provision	Percentage
Cinemas, Gaming Parlors, Casinos	1.83	3810	10
Communication Systems	1.46	3048	8
Graveyards	0.18	381	1
Life support systems	2.75	5715	15
Malls	1.46	3048	8
Multispecialty Hospital	2.02	4191	11
Municipality Buildings	0.73	1524	4
Offices	0.55	1143	3
Schools And Colleges	2.02	4191	11
Storage	1.83	3810	10
Vacant Area for Future Expansion	2.2	4572	12
Water Storage	1.28	2667	7
Research And Industries	0.91	1905	5
<b>Total</b>	<b>18.31730769</b>	<b>38100</b>	<b>100</b>

The arrangement of two colonies is shown in Fig 2.6.8:-

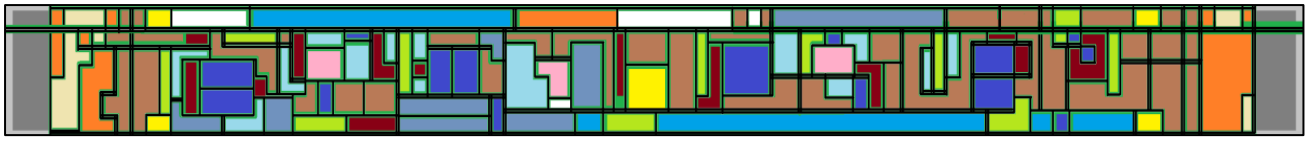

Figure 2.6.8: Area allocation inside residential colonies

Table 2.6.3	
Legend	
White	Banks
Dark Red	Clinics And other Local Specialists
Pink	Community Halls
Orange	Green Cover
Blue	Gymnasium
Yellow	Trees And Bushes
Grey	Vacant Area for future Expansion
Black	Transportation Roads
Light Blue	Markets
Light Grey	Parks & Ponds
Light Green	Holy Places
Dark Blue	Life Support Zones And Telecom Industry
Yellow	Fire Stations
Brown	Residential Colonies
Green	Walking Areas

The arrangement of the 2 “Common Zones” is as follows:-

Table 2.6.4 Area allocation of Common Zones	
Legend	
Red	Schools And Colleges
Blue	Graveyard
Light Blue	Malls
Light Green	Vacant Area For Future Expansion
Yellow	Research And Industries
Pink	Offices And Information Technology Industry
Black	Transportation Roads
Green	Life Support Systems
Dark Red	Communication Systems
Light Green	Multispecialty Hospitals
Pink	Storage And Printing Industry
Yellow	Municipality Buildings
Grey	Water Storage
Brown	Cinemas , Gaming Parlors ,Casinos

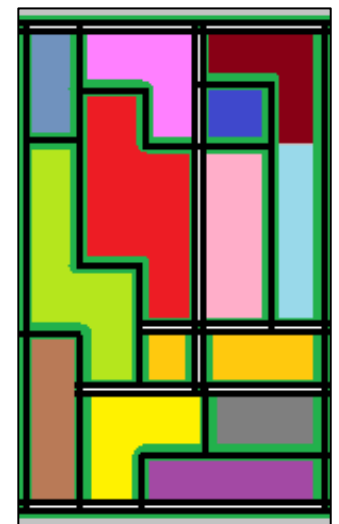

Figure 2.6.9 Area Allocation of “Common Zones”









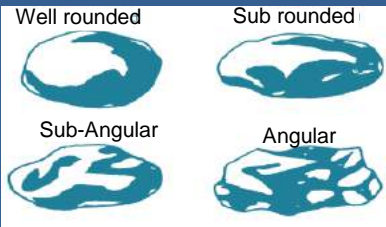

## AGRICULTURAL TRUNCATED TORUS

### Floor Structure and Materials

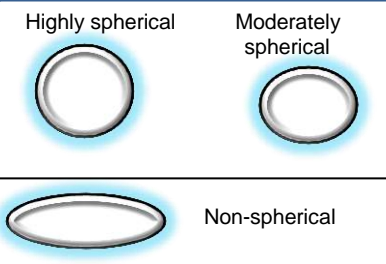
The material used in flooring would obviously be Nafion, also termed as “*Transparent soil*”. Nafion is a Sulphonated Tetrafluoroethylene based Fluoropolymer Co-polymer. Once interlaced into pellets of different sizes, it shows soil like properties like percolation, water retention, aeration etc.

First, we will specify the pellet sizes and shapes, into which Nafion will be woven, that will be used in different compositions in different pirasos.

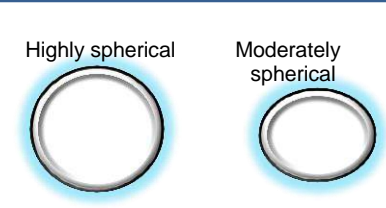
**Table 2.6.5 Nafion pellets and specification**

Nafion Pellet	Shapes	Size(average diameter)
<b>Rent (रेत: Sand in Hindi) Pellet</b> 	Well-rounded  Sub rounded  Sub angular  Angular 	<b>FINE:</b> 63µm - 200µm  <b>MEDIUM:</b> 200µm - 630µm  <b>COARSE:</b> 630µm - 2000µm
<b>Mitti (मिट्टी: Clay in Hindi) Pellet</b> 	Highly spherical  Moderately spherical  Non-spherical 	<b>FINE:</b> 2µm - 3µm  <b>MEDIUM:</b> 3µm - 4µm  <b>LARGE:</b> 4µm - 5µm
<b>Khaad (खाद: Silt in Hindi) Pellet</b> 	Highly spherical  Moderately spherical 	<b>FINE:</b> 3.9µm - 4.5µm  <b>COARSE:</b> 4.5µm - 6.25µm
<b>NOTE:</b> Khaad pellets are nearly uniform		

Now, mixing various pellet sizes in different proportions, we simulated different soil types and then got the desired nutrient we required for each crop by adding it artificially. Here are the simulated soil types for each Piraso.

**Table 2.6.6 Soil simulation using Nafion**

PIRASO NUMBER	SOIL TYPE SIMULATED	COMPOSITION
PIRASO 1	LOAM	REHT PELLETS : 40-45% KHAAD PELLETS: 37-40% MITTI PELLETS: 20-23%
PIRASO 2	SANDY LOAM	REHT PELLETS : 52-54% KHAAD PELLETS: 29-31% MITTI PELLETS : 15-17%
PIRASO 3	SANDY SILT LOAM	REHT PELLETS : 46-51% KHAAD PELLETS: 32-35% MITTI PELLETS : 14-17%
PIRASO 4	SANDY CLAY LOAM	REHT PELLETS : 49-55% KHAAD PELLETS: 21-25% MITTI PELLETS : 21-30%
PIRASO 5	SANDY LOAM	REHT PELLETS : 52-54% KHAAD PELLETS: 29-31% MITTI PELLETS : 15-17%
PIRASO 6	CLAY LOAM	REHT PELLETS : 25-45% KHAAD PELLETS: 10-12% MITTI PELLETS : 27-40%
PIRASO 7	SILT CLAY LOAM	REHT PELLETS : 18-20% KHAAD PELLETS: 15-22% MITTI PELLETS : 24-35%
PIRASO 8	LOAM	REHT PELLETS : 40-45% KHAAD PELLETS: 37-40% MITTI PELLETS: 20-23%
PIRASO 9	SEMI-SANDY	REHT PELLETS : 52-59% KHAAD PELLETS: 12-21% MITTI PELLETS : 21-29%

***Floor Layout and Area allocation***

Purpose	Area (in m <sup>2</sup> )	Percentage
Food grains	391328.5432854	33.2
Vegetables	175626.3064306	14.9
Pulses	87223.8319372	7.4
Tea and coffee	155588.4569689	13.2
Fruits	51273.4687738	4.35
Fibrous crops	78972.9289160	6.7
Oil crops	104904.3384108	8.9
Spices	68364.6250317	5.8
Animal Husbandry	29467.5107895	2.5
Flowers	22395.3082001	1.9
Nursery and transplantation centers	13555.0549632	1.15
Total	1178700.4315827	100



The agriculture torus is segmented to 9 pirasos each having an area of  $130966.7146203\text{m}^2$ . The total Utilizable agricultural area (excluding area of atmospheric separation corners) =  $1178700.4315827\text{m}^2$

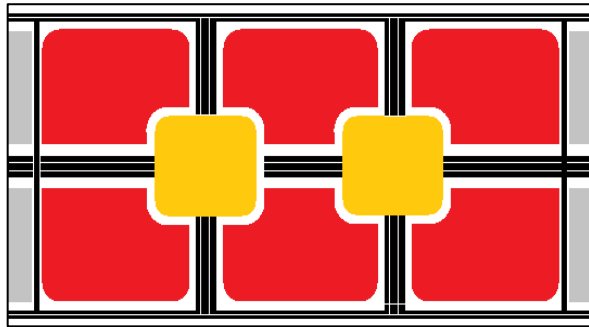

Figure 2.6.10: Piraso Area Allocation Type 1

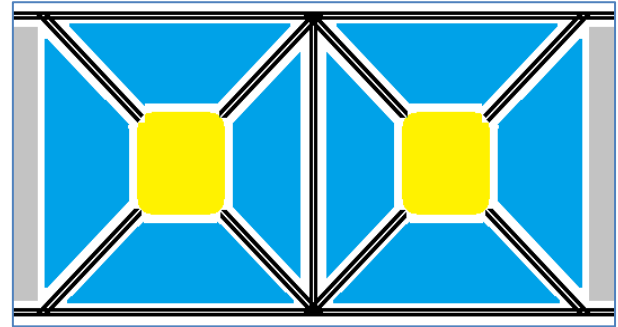

Figure 2.6.11 Piraso Area Allocation Type 2

## INDUSTRIAL WAVES STRUCTURE

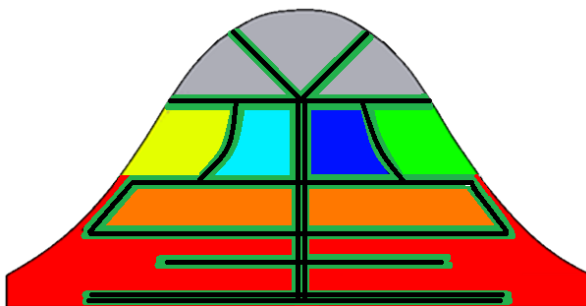

Figure 2.6.12 Area Allocation of Industrial Waves

Legend	
Processing Shop	Heavy Industry
Packaging Department	Refining , Pre-processing And Import Area
Storage Area	Testing Units
Light Industry	

### ***Floor structure and Materials***

The floor has a very simple and linear structure. The industrial waves should have flooring that is shock absorbent, hard as well as rigid for tough tasks. Lowermost layer should be made out of IPC. The next layer will be made out of Lotus water Ghost Super Hydrophobic water-pipes followed by Polystyrene Dimethyl Siloxane Di-block Co-polymer and water in order to control any sort of shocks from explosions in the worst case scenario, electrical supply system. The layer above that will be made out of Carbon Nanotube based super rubber which is highly shock absorbent material flowed by Tantalum Hafnium Carbide which is a material which has the highest melting point ever observed ( $4125^{\circ}\text{C}$ ), and Tufftrak® Road Matting Material.

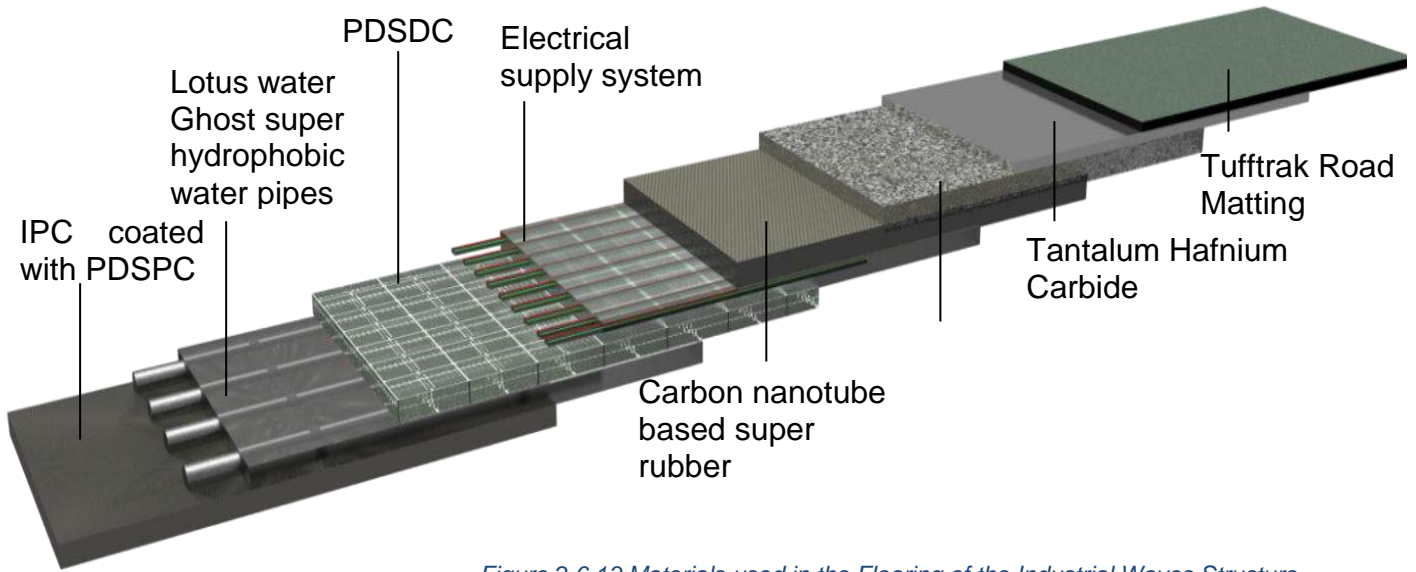

Figure 2.6.13 Materials used in the Flooring of the Industrial Waves Structure

RECREATION CENTRE

The structure of the floor consists of a truncated sphere and 2 cylinders. The materials are the same as the ones used in residential hybrid torus.

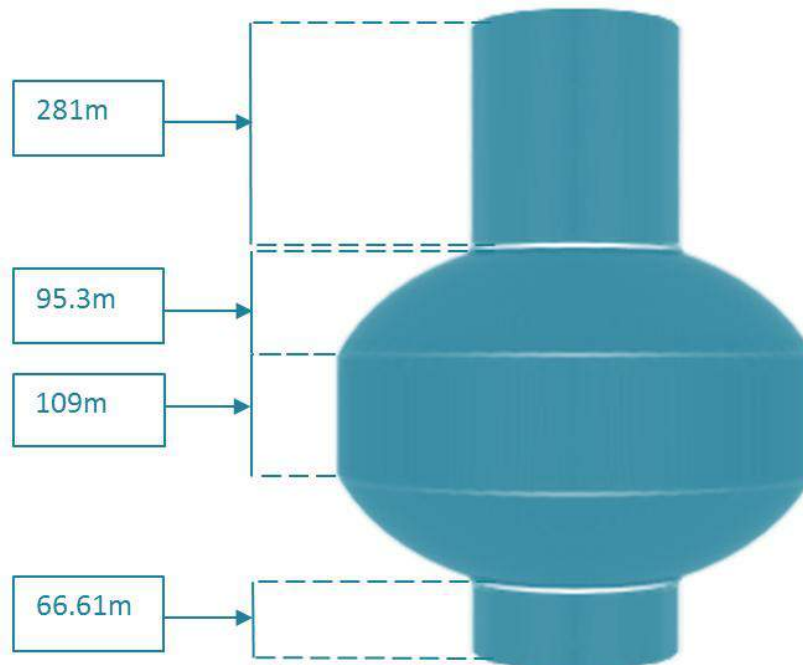

Figure 2.6.14 Structural parameters of Floor of Recreation Centre

## MARTIAN BASE

Martian Base is the most important base among all other resource extracting bases of VONA as it provides around 70% of the materials which will be used for construction of VONA. The Martian Base will also promote tourism which will increase its revenue collection. Since water is available in large quantity on the Martian surface, it will be extracted to provide for the residents of VONA.

## LOCATION OF THE BASE

The location of the Martian base will be near the Victoria crater which lies in the Meridiani Planum region of Mars, precisely at  $2.05^{\circ}\text{S}$ ,  $5.50^{\circ}\text{W}$ . The Victoria crater has large deposits of mineral resources and so is one of the locations on Mars that can bring a lot of profit for VONA. The main reasons for choosing the location near the Victoria crater is that it is quite close to the equator, it will be easy for the Solar cells to absorb light from the Sun and this will increase the production of electricity converted from solar energy. There will be two outposts of the Martian Base.

## STRUCTURE OF THE MARTIAN BASE

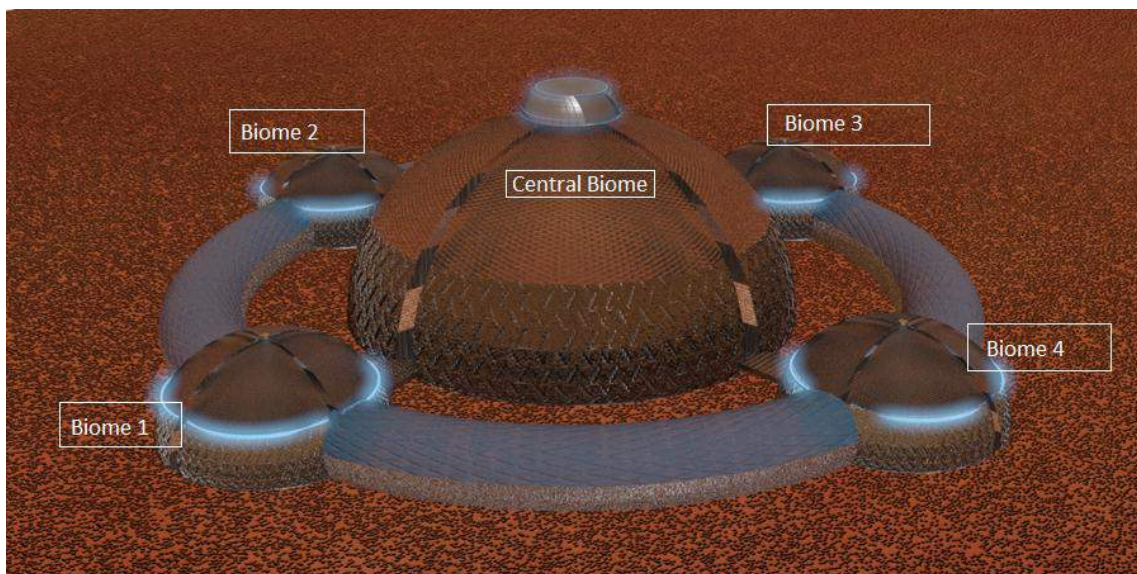

Figure 2.7.1 Martian Base

The structure of the Martian Base is divided into 5 domes, 4 small domes and a large central dome.

- **Central Biome:** The main dome will be basically for the Residential Purposes and Recreation purposes.
- **Biome 1:** The side dome 1 as mentioned above will be divided into 4 sectors. This dome will be an industrial Dome and all the excavations and resources will be brought here for processing and packaging for export and transport. This dome will have direct connectivity to the docking port for transport of resources.

- **Biome 2:** The side dome 2 will be totally used for Storage of the processed resources from the Industrial, Agricultural, Water and Electricity sectors.
- **Biome 3:** This dome will be totally for agriculture and food processing. This will have climate controlled environment which will suit the conditions of the agricultural plants. This will include Zeoponics, Aeroponics and Hydroponics. The weather and climate will be controlled using the same techniques used in the Agricultural truncated torus of VONA
- **Biome 4:** The side dome 4 will be for the life support systems. Air, Waste and water. Plus another sector will take care of the repairing of the Martian Base Vehicles.

## MINING

Researches have shown that Mars has large amounts of raw materials, resources and minerals which will be extracted and taken to the base near the Victoria crater where they can be processed into the materials which can be used in the industries built in VONA. The core of Mars mainly consists of iron and sulphur. There are also silicates in the mantle of Mars and underneath the crust; there is basalt and iron oxide. The Mars rovers and many meteorites which have fallen on Earth, from Mars, show that there are many valuable

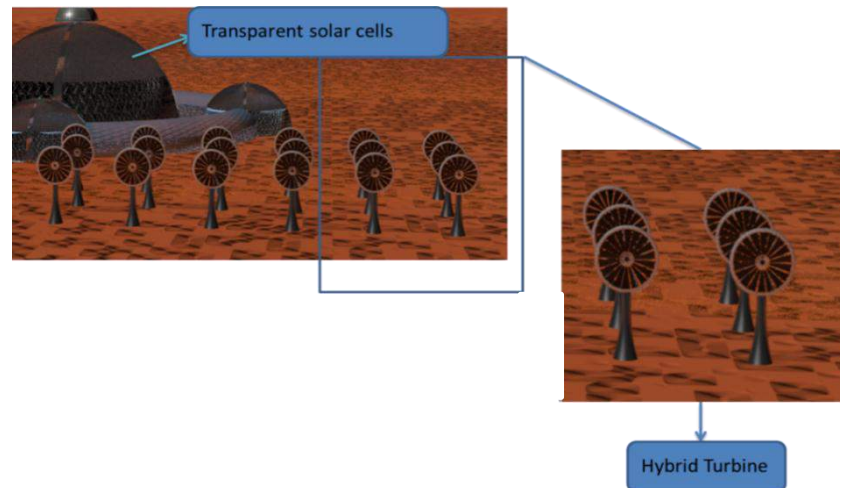

Figure 2.7.2: Electricity generation processes in Martian Base

minerals under the surface of Mars. In many researches and explorations done by the Mars rovers, it has been detected that magnesium, Aluminium, iron, titanium and chromium are commonly found on Mars. Lithium, cobalt, zinc, copper, nickel, tungsten and gold are also found on Mars but these are relatively smaller in amount. The Mars rover "Opportunity" also discovered small structures called blueberries which have been studied and declared to be rich in hematite which is a major ore of iron. Electricity in the Martian Base will be produced using the Hybrid turbine and the transparent solar cells.

## LOCATION

Location preferred for the Lunar Base is the Shackleton Crater situated near the Geographical South Pole of Moon (89.54° S latitude and 0.0° E) longitude. The width

of the Crater is about 12.9 miles and is about 2.6 miles deep. The diameter of the crater is about 4 miles in diameter.

## STRUCTURE

Fig 2.7.1 shows the structure of Lunar Base

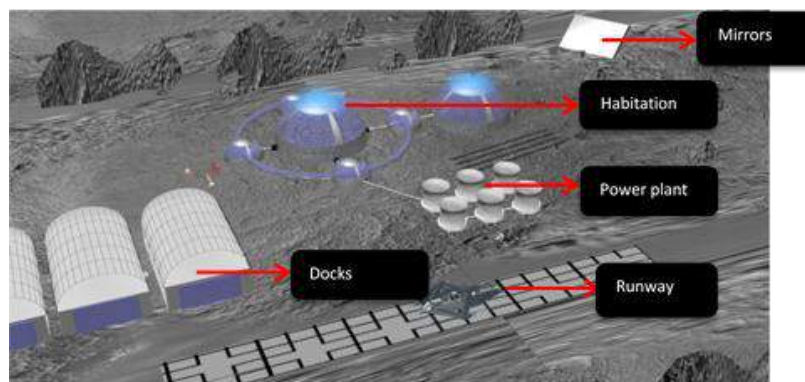

Figure 2.7.1: The Lunar Base

## REASONS

The reasons for choosing this location are as follows:

### Minerals

The location has been chosen because of the widespread availability of minerals and resources which are needed for the survival of the human beings living in the base. It is rich in minerals. The main resource that is found on this Crater is water.

The most important mineral on moon is Ilmenite. Ilmenite also known as Iron-Titanium-Oxide can be used to produce oxygen on the Lunar Base. This will also be used for removing the bacteria Bacillus Anthracis from the Lunar Base and this will be exported to the settlement for the same.

Surplus minerals will be sold to Earth.

The other minerals extracted from the Lunar Base are:

- Silicon, Iron, Calcium, Magnesium, Anorthite, Silicates, Olivine, Aluminium Trioxide, Titanium Dioxide, Silicon Dioxide, Chromium [III] Oxide etc.

### Fuel extraction

The next operation that will be performed in the Lunar Base is Extraction of Fuels. The next generation high velocity fuels are Helium-3 and Deuterium. These fuels both are found beneath the surface of Moon. Ships will be docked to the lunar base and then they will be re-fuelled and then launched off to the Space Settlement or to the Earth Respectively.

### Mining

Mining will be carried out in the Lunar Base by automations along with the supervision of the crew wearing special Bio suits. Minerals such as mentioned in the above section will be extracted from the lunar base. Also 3554 Amun will be extracted here after the capturer lands here.

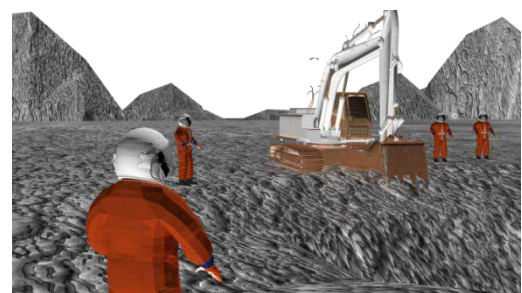

Figure 2.7.2 Lunar Mining

### ASTEROID CAPTURE

The asteroid that VONA will capture will be 3554 AMUN. This asteroid as mentioned in the location can fetch approximately a sum worth \$22 trillion (theoretically). Also as mentioned in location, this asteroid will be closest to earth on 23 March 2061. Hence, the asteroid capturer will serve in capturing 3554 AMUN.

#### Mechanism

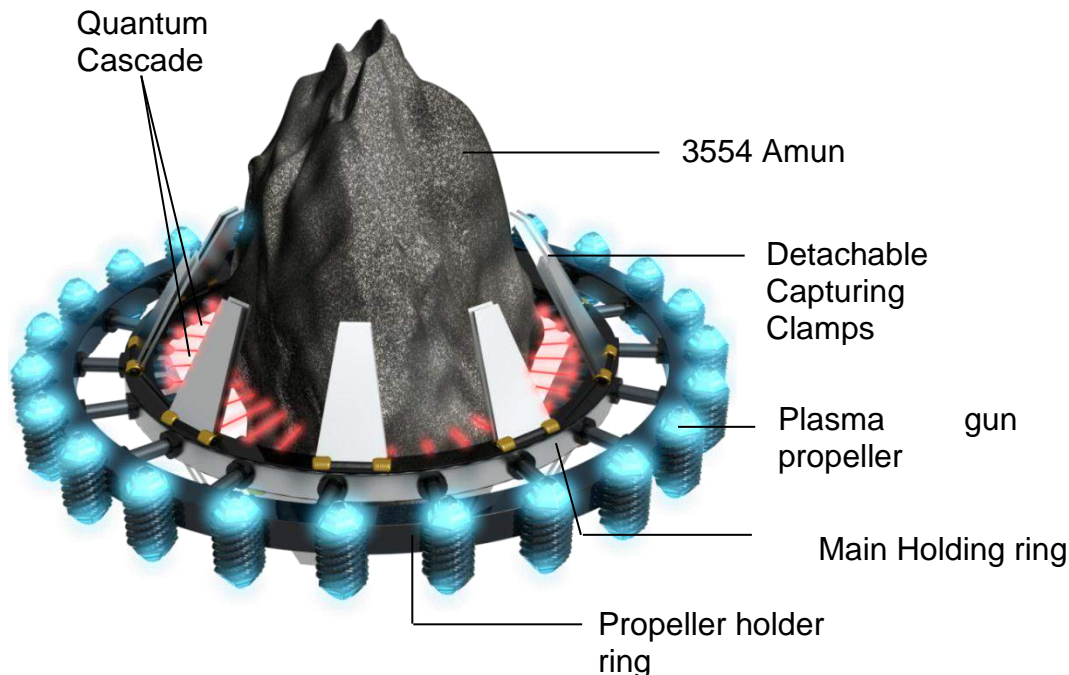

Figure 2.7.3 Structure of asteroid capturer

The asteroid capture machine 3554 Amun will be broken into 2 parts using quantum cascade LASERS. The detachable clamps, equipped with HTPB (Hydroxyl Terminated Polybutadiene) propellers would capture each part. These crocodile shaped clamps would open up and arrange themselves parallel, so that they clutch hold of each the cut-off part of asteroid. After capture, these would propel each part towards lunar base. The main holding ring would later follow the same process and would later be dismantled in the lunar base.

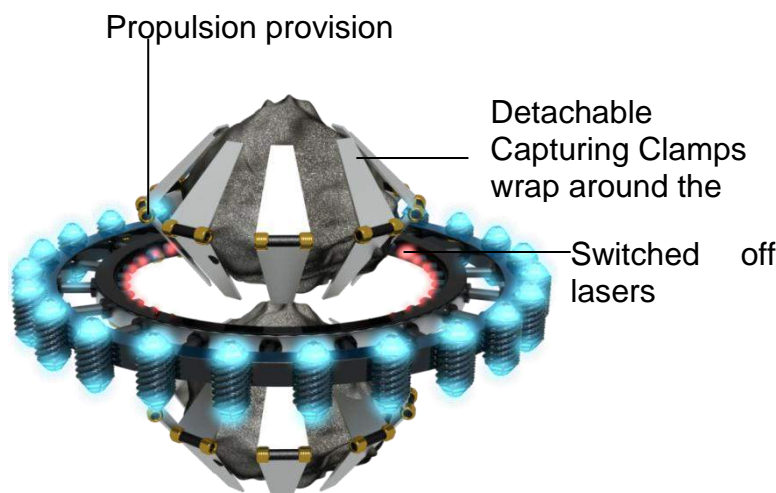

Figure 2.7.4 Asteroid capture process



# SECTION 3.0 LIFE SUPPORT

SECTION 3.0 LIFE SUPPORT

VONA will have a Gravity generation system for each area. Humans will be provided with earth like gravity for their well-being. For generation of gravity, VONA will be rotated around the central cylinder.

Each part of the structure will rotate independently at different rpm according to the requirements. Rotation would be done using Solar Electric Propellers (mentioned in Ch 2.0 page 2.1).

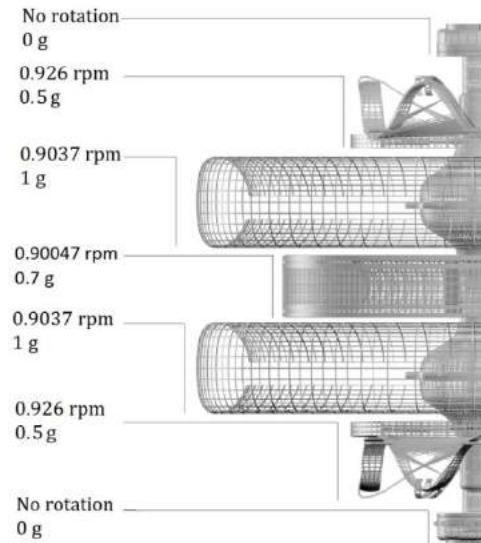
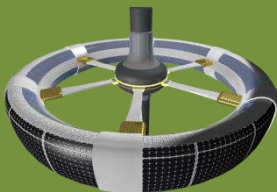
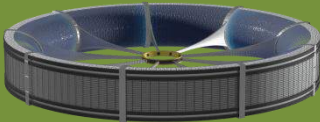
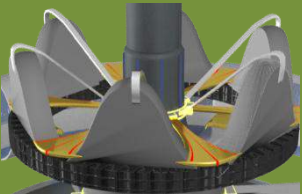

Figure 3.1.1: Rotational configuration of Structural components

Table 3.1.1 Gravitational Specifications

Part Name	Amount Of Gravity At Hull	Reason For Gravity Level
 Residential Hybrid Torus	1 g	Hybrid Residential Tori will have 1 g gravity level to simulate earth like gravity.
 Agriculture Torus	0.7 g	Agricultural Truncated Torus has been provided with gravity level of 0.7 g as experiments show that plants grow faster in lower gravity levels.
 Industrial Wave Structure	0.5 g	Industrial Waved Structure hosts a gravity of 0.5 g for easier production because lower gravity will reduce workload on heavy machinery for moving heavy objects or materials.
Recreation Centre	Varying At levels 0.2864g-0.116g	The Recreation Centre is a Single Structure connected to the central hub. It is divided into three sections i.e. the Uniform Gravity Recreation, Non Uniform Gravity Recreation and the Research Area.

GRAVITY CALCULATIONS



The calculation of each part has been done using the formula provided below.

$$A_c = \omega^2 \times R$$

$$A_c = \omega^2 \times R$$

$$\omega = \sqrt{\frac{A_c}{R}} \text{ radians/second}$$

To find the Rpm

$A_c$  = Centripetal acceleration

R = radius

$\omega$  = angular velocity

Because  $2 \pi$  radians = 1 rotation

1 second = 1/60 minutes

We have the Formula  $Rpm = 60 \times \frac{\sqrt{\frac{A_c}{R}}}{2\pi}$

Calculations of all gravity levels of different parts have been given in [Table 3.1.2](#)

Table 3.1.2 Pseudo-Gravity Calculations For each structural component.	
<p><b>Residential COMBINED Torus</b>                      Radius=1095m                      Required Gravity=1g</p> $30 \times \frac{\sqrt{\frac{1}{1095}}}{\pi}$ <p>=0.903700 RPM</p>	<p><b>Agricultural Truncated Torus</b>                      Radius = 772 m                      Required Gravity=0.7g</p> $30 \times \frac{\sqrt{\frac{0.7}{772}}}{\pi}$ <p>=0.900475 RPM</p>
<p><b>Industrial WAVES Structure</b>                      Radius=520.5 m                      Required Gravity=0.5g</p> $30 \times \frac{\sqrt{\frac{0.5}{520.5}}}{\pi}$ <p>=0.926843 RPM</p>	<p><b>Recreation Centre</b>  <b>Research Area; Required Gravity</b>  <b>0.2864 g to 0.116g</b>                      Radius=127.33783m                      g=0.116 g                      rotations=0.903 RPM</p> <p><b>Non Uniform Gravity Recreation</b></p> <ol style="list-style-type: none"> <li>1. Shortest Radius:130.337m                          G=0.1188g                          rotations=0.903 RPM</li> <li>2. Longest Radius:313.11m                          G=0.285g                          rotations=0.903 RPM</li> </ol> <p><b>Uniform Gravity Recreation</b>                      Radius=314.1 m                      G=0.2864g                      rotations=0.903 RPM</p>

Figure 3.2.1 : Composition of Air

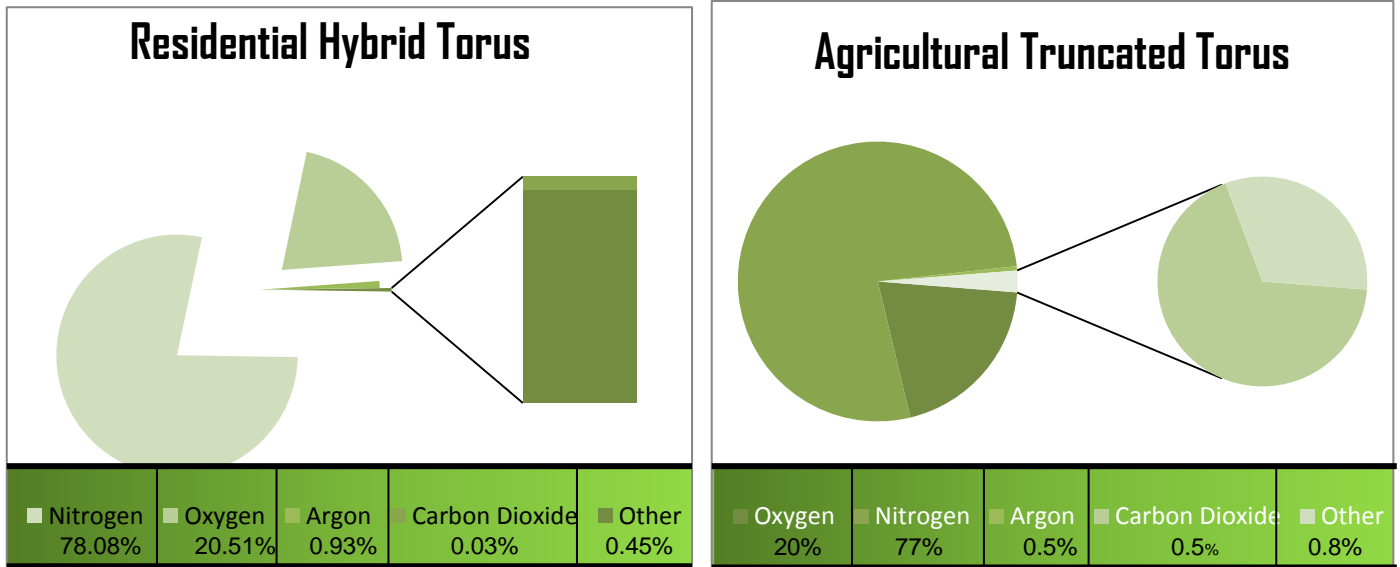

According to NASA's latest research, the oxygen requirement per person would be around 0.84 Kg/day. VONA has population of 16640 persons who would require around 13977.6 kg/day of Oxygen. 6500 Kg per day can be produced using either of these methods. The rest of the oxygen will be produced in the agriculture sector. Oxygen pressure would be kept at 22.7 Kpa which is the oxygen pressure at sea level

### OXYGEN FROM LUNAR SOIL

Ilmenite (FeTiO<sub>3</sub>) along with raw lunar soil and rutile will be extracted from the lunar soil; successive heating would separate hydrogen from the lunar soil at 600° C and it would decompose into a mixture of iron and rutile (TiO<sub>2</sub>) at 900°C. At 1525°C iron will melt and leave behind rutile which will decompose into titanium and O<sub>2</sub> at 1640°C. Every 1000g of Ilmenite can produce 317.88g of oxygen.

### GASES FROM MARS

Other than the Moon, Mars too will be important for the extraction of gases. The composition of Mars's atmosphere is shown in Fig 3.2.2

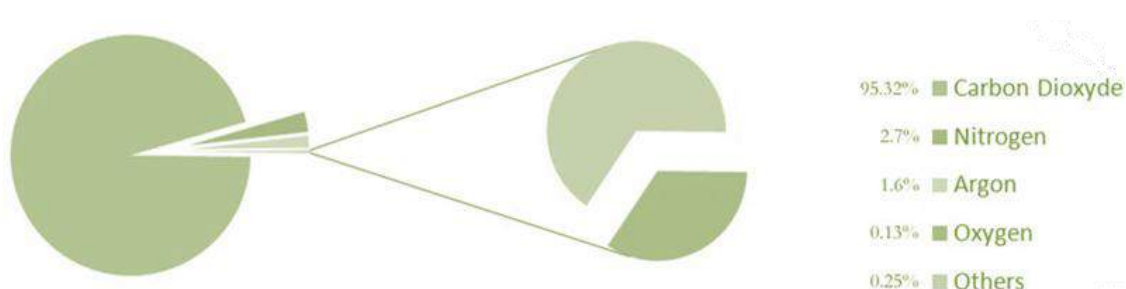

Figure 3.2.2: Composition of Mars' atmosphere

## EXTRACTING OXYGEN

Martian atmosphere is 95% carbon dioxide. This carbon dioxide will be captured using molecular sieve with pore size of 0.4nm which would decompose into carbon monoxide and oxygen using the following methods:

### Davis' Method

CO<sub>2</sub> can be decomposed using Davis' method, in which Argon-Carbon Dioxide mixture would be taken in a shock tube and would be heated to 6527°C. Shock waves would be passed through the system which would lead to decaying infrared emissions. Carbon Dioxide would be decomposed into Carbon Monoxide and Oxygen. Carbon Monoxide can be later released into Martian atmosphere.

### Ultrasonic Electrolysis

Ultrasonic sound with a frequency of ~ 42.7 kHz would be passed through heated water making it unstable and disassociate it into O<sub>2</sub> and H<sub>2</sub>.

## EXTRACTING NITROGEN

### Nitrogen extraction and Helium Isolation Using Molecular Sieve

Ammonia and Helium would be separated from meteorite dust and Martian atmosphere using alumino silicate molecular sieve with pore size of 0.3 nm. Both of them would be later separated from each other using *polysulphone amide membrane*.

### Separation of Ammonia from Martian Atmosphere

Ammonia would be separated from air sample by using Alumino-Silicate molecular sieve with a pore of 0.3 nm. Ammonium obtained from Martian atmosphere would be divided up; a part of it would be separately pumped into a containment chamber where it would be reserved to be transported separately to the agricultural torus. The Ammonia obtained would be decomposed thermally to produce nitrogen and hydrogen. Nitrogen and hydrogen can further be separated using fractional distillation.

## TECHNIQUES FOR EXTRACTION OF MULTIPLE GASES

### VPSA (Vacuum Pressure Swing Absorption)

In VSPA, air is drawn into the system and is passed through the system chambers. Martian air will be passed through platforms with zeolites for the absorption of oxygen, carbon dioxide, nitrogen and argon. (Table 3.2.1)

**Table 3.2.1 Zeolites utilized**

Gas	Zeolite
Oxygen	LiLSX Zeolite
Nitrogen	LiAgX Zeolite
Co <sub>2</sub>	SSZ-13 Zeolite
Argon	Aga Zeolite

**Table 3.2.2 Pressure maintenance**

Gas	Pressure Required
Oxygen	22.7 kPa
Nitrogen	26.6 kPa

Carbon Dioxide | 7 kPa

## Air Pressure

TABLE 3.2.2 shows the requirement of pressure exerted by various gases VONA.

## AIR REVITALIZATION

Air level would be constantly monitored so that it doesn't have unwanted gases.

Name of gas	Detection Method	Removal method
Carbon Dioxide	NCCDD (Neonatal Colorimetric Carbon Dioxide Detector )	Carbon Dioxide Scrubbers, Molecular sieves( to Capture)
Carbon monoxide	Electrochemical Carbon Monoxide Detector	CO Scrubber, CO Diversion System

Once Carbon Dioxide is captured, it will be sent to the agricultural truncated torus to help facilitate the growth of plants. On the other hand, a large quantity of oxygen would be generated in the agricultural sector. This oxygen can be captured using oxygen specific molecular sieves and sent to the residential sector.

## NCCDD (Neonatal Colorimetric Carbon Dioxide Detector)

This technique is based on a colorimetric carbon dioxide detector membrane having pH sensitive chemical indicator that undergoes colorimetric change in the presence of carbon dioxide. Whenever the membrane comes in contact with CO<sub>2</sub> it changes color. The amount of color change depends on the concentration of carbon dioxide that comes in contact with the membrane.

## Removal of Industrial Gaseous Waste

Type of Treatment System	Mechanism Used	SEPARATED GASEOUS POLLUTANT
FIRST LAYER(of molecular sieve)	Pores of size 0.5 nm	C <sub>4</sub> H <sub>9</sub> OH, C <sub>4</sub> H <sub>10</sub> , C <sub>4</sub> H <sub>9</sub> SH
SECOND LAYER(of molecular sieve)	Pores of size 0.4 nm	CO <sub>2</sub> , SO <sub>2</sub>
THIRD LAYER(of molecular Sieve)	Pores of size 0.3 nm	H <sub>2</sub> O, NH <sub>3</sub>
OXIDATION USING EDTA	Oxidation of H <sub>2</sub> S using EDTA as catalyst for its treatment.	H <sub>2</sub> S
WET SCRUBBING	Removal of SO <sub>2</sub> in Wet scrubbers using NaOH in an airstream of 42,500 m <sup>3</sup> /hr. at 66 °C	SO <sub>2</sub>

Treatment of H<sub>2</sub>S would be carried out using complex Fe(III) – Ethylene Diamine Tetra-Acetate(EDTA), which is an efficient and selective catalyst for H<sub>2</sub>S oxidation.

## AIR FILTRATION

Air filtration would be carried out using the following techniques:

M.P.P.S Hyper HEPA



Hyper HEPA uses an aggregate of fibers to disinfect air with an efficiency of 99.97 to  $\geq 99.98\%$  (removing particles as small as 0.003 microns). Sheets of thin Aluminum Filter fibers along with activated carbon slab and zeolites would facilitate air purification.

### One Atmosphere Uniform Glow Discharge Plasma (OAUGDP)

Figure 3.2.3: MPPS Hyper HEPA

Plasma tubes would also be installed in M.P.P.S Hyper HEPA. The air will be allowed to pass through very low power plasma tubes which contain the dark discharge coronas. When the air containing impurities will pass through the plasma tubes and dark coronas, the impurities will get ionized with different charges and hence, will move to their respective terminals that are sheets having positive and negative charges.

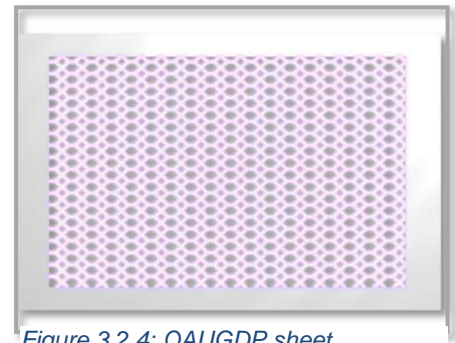

Figure 3.2.4: OAUGDP sheet

The air particles will then be allowed to pass through but this air will still contain the microbial bodies which are smaller than 3 nm and cannot be separated from the air simply using the Silver Nano Particles. For removing the microbial bodies which are smaller than 3 nm, an increase in size of these bodies will be applied by reduction and calcination at  $450^{\circ}\text{C}$ .

### Silver Nano-Particles

Second stage of primary purification would be carried out using Silver Nano-particles with pore size of 3 nm which would separate all organic non-gaseous impurities from air i.e. dust, dirt, pollens and smoke.

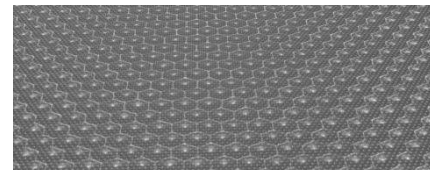

Figure 3.2.5: Structure of Silver Nano particles

## Polarized Media Electronic Air cleaners with Activated Carbon Slab

A 24-volt current would be converted to DC voltage to establish a polarized electric field. All particles passing through this field would get polarized and would tend to cling to the activated carbon slab. Activated carbon will also separate VOCs and other organic compounds and odor from air. The efficiency of these air cleaners will increase with increasing load.

### Ionic Air Purifiers

Air will be ionized; till all the particles get separate charges and attract each other and will reach a stage where they are too heavy to stay airborne. At this stage clumps of dust will start falling which will be later cleaned by vacuum suction.

### Ultraviolet microbial disinfection of Air

Ultraviolet air purifiers will be used in VONA to deactivate the microbes which will be present in VONA like airborne bacteria, viruses, germs and allergens. UV light will be emitted using UV-C germicidal light bulbs which can kill 99% of the microbes present in the air but the efficiency of these light bulbs will be decreased to 95% by decreasing the power supply to increase immunity of residents.

**TABLE 3.2.5 Ultraviolet Microbial Disinfection**

PURIFICATION STAGE	Technique Used	END RESULT
<b>Primary</b>	MPPS Hyper HEPA. Ionic Air Purifiers And silver Nano particle cluster	Air without non-gaseous impurities
<b>Secondary: First stage</b>	UV purification and Airocide FeTiO <sub>3</sub>	Air without most Organic impurities. Release of Ozone.
<b>Secondary: Second Stage</b>	PMEAC	99.9995% pure air

## Carbon Dioxide Scrubbing

- The air will be passed into a compression chamber where it would be continuously cooled and compressed. Here a Carbon Dioxide scrubbing solvent (after cooling) called MEA (Mono-Ethanolamine) will be released.
- CO<sub>2</sub> would then be decomposed using Davis' method, in which Argon-Carbon Dioxide mixture would be taken in a shock tube and would be heated to 6527. °C
- Carbon Dioxide would be decomposed into Carbon Monoxide and Oxygen. Carbon Dioxide scrubbing can also be done by establishing RCRS (Regenerative carbon dioxide removal system).
- The sorbent for absorbing CO<sub>2</sub> would be silver oxide along with zinc oxide along with which air would be pumped at 205°C for 9-12 hours

## Weather and Climate

The people residing in VONA would not be able to live without any appropriate climate and humidity control system, mimicking the conditions of Earth.

### CYCLE OF SEASONS

The seasons in the residential hybrid tori will be controlled according to [Table 3.2.6](#). The seasons will not change within a day.

**Table 3.2.6 Seasons in VONA**

Name of Season	Temperature	Humidity
<b>Summer</b>	25 to 31° C	30 to 34%
<b>Rainy</b>	25 to 29°C	50 to 70%
<b>Winter</b>	10 to 13.5° C	28 to 30%
<b>Spring</b>	13.5 to 16° C	31 to 37 %

### CREATION OF ARTIFICIAL SEASONS

Controlling heat and cold

### Thermo-acoustic Refrigeration (for decreasing temperature)

The source from which acoustic waves are produced is known as the “driver”. The driver emits a sound frequency in a tube filled with high pressure gases. This tube is known as the resonator. Between the tubes there is a “stack” of porous material which is solid in order to block the path of the sound frequencies. Then thermo-acoustic effect takes place in order to cool down the other end and produce refrigeration. Planting this technique on large scale can produce artificial air-cooling in VONA so that the people could experience winter.

### Thermal Induction (for increasing temperature)

Water will be used to increase the temperature of the living areas. This will be done using Thermal Induction. Waste water will be heated using thermal induction and then the air produced in the heating will be directly supplied to the residential hybrid tori.

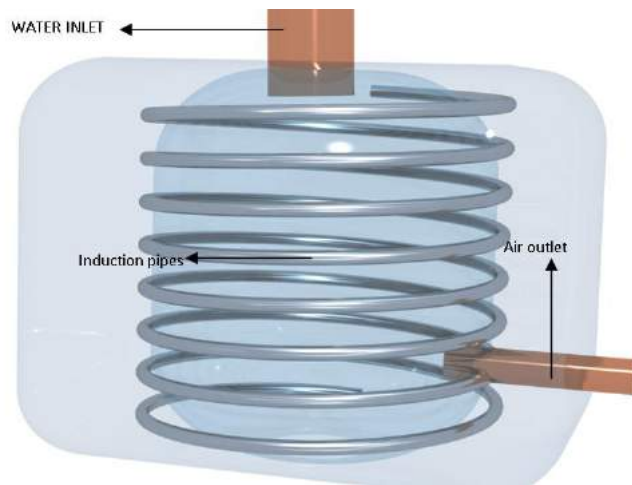

Figure 3.2.7: Thermal Induction refrigeration driver

### Controlling Humidity

Humidity will be controlled using these devices

#### Ultrasonic Humidifiers (for increasing humidity)

Ultrasonic Humidifiers have a metallic diaphragm which pulsates at a frequency that cannot be heard by human ear. This technique is similar to loudspeakers. This frequency will produce water droplets.

#### Molecular sieves (for decreasing humidity)

The molecular sieves which will be used to remove humidity from the climate will have pores which are of 0.19 nanometers.

### Rain and Snow

#### Cloud Seeding

To create artificial rain cloud seeding technique would be used. In this technique, Silver Iodide is dispersed into the air which acts as nuclei for the water to condense around. So the humidity will be increased to very high above the region where it is to rain and then silver iodide would be released into air. This would cause rain. During the rainy season in any part of the VONA, it would rain about once or twice a week.

Water is the basic requirement of life. This entity will be taken great care of in VONA.

**WATER REQUIREMENTS**

Water would be used all over the time. The Water given here is calculated

**WATER PROCUREMENT**

It has been proved by the Indian Chandrayaan Impact Probe that lunar craters have water. The Shackleton Crater is 20% water.

Vastitas Borealis Region in Mars has around 99% of pure water and only 1% dirt in the available water. There is around million cubic kilometers of water in this region.

- Water will be procured from the sweat from the people’s bodies. After it has been disinfected it can again be used for drinking
- Recycling Urine [Part of Black



These places in the sweatshirts will be placed with Wicking Fibres.

Water] will be useful in VONA. Urine is free of bacterium till 15 minutes of

Figure 3.3.1: Placement of Wicking fibres



excretion and recycling it before this time limit would put much less load on the filtration system.

**EXTRACTION OF THE REGOLITH**

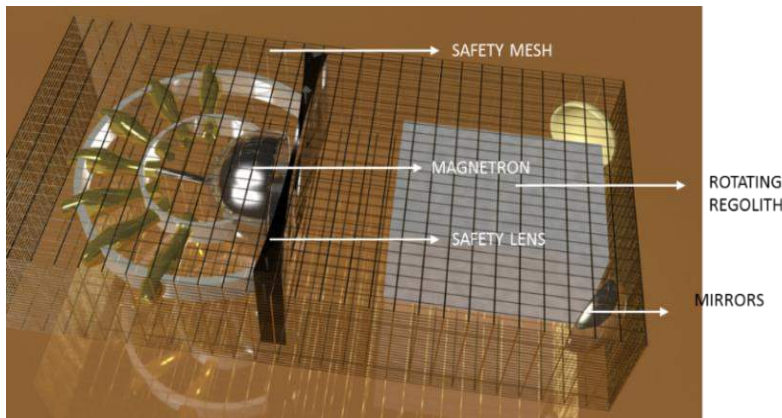

Figure 3.3.2: Regolith Extraction Machine



**Table 3.3.1 Total Water Used**

Sector	Total Water Used
Residential	60 L
Agricultural	89 L
Industrial	89 L
Institutions and Commercial Zones	200 L
<b>Total Water Used</b>	<b>438 L</b>

## WATER PRODUCTION

Water will be produced using the following processes in VONA enabling the water reserves to last longer.

### Bosch Reaction

Water in this reaction will be produced using  $H_2$ ,  $CO_2$  and  $O_2$ . A

nickel catalyst will be used to

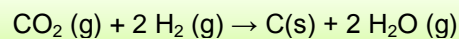

speed up the reaction in the process. Nickel can be also extracted from the lunar surface near the

temperate areas of the moon.

### Sabatier Reaction

The Sabatier reaction involves carbon and hydrogen to produce methane and water at a high temperature. The Sabatier reaction can also be powered by the nickel catalysts. The reaction is as follows:  $CO_2 + 4H_2 \rightarrow CH_4 + 2H_2O$

### Super critical Carbon dioxide

Supercritical Carbon dioxide can be used to harvest water from the moon. Large craters on lunar surface have been reported to have hydrogen and hydroxyls. These samples of regolith can be immersed in supercritical Carbon dioxide to form oxygen which can be processed to form water using this reaction:  $2H_2 + O_2 \rightarrow 2H_2O$ . Addition of Hydrogenation metal Catalysts can make this reaction possible.

### Making Light Water Artificially

Light water is basically the water with extremely low quantity of Deuterium. This light water can be produced when the water production is going through  $2H_2 + O_2 \rightarrow 2H_2O$  process and platinum catalyst is used.

## WATER RECYCLING

Black Water will be purified using the following Processes

- 1. Centrifugation** Centrifugation will be done to Remove the solid faeces, immiscible liquids, and all other impurities in liquids.
- 2. Aeration** Water then will be sent for Aeration and Aerobic Respiration which will remove many microbial impurities and the methane gas and the waste water will be sent to the agricultural sector.
- 3. Electrode-ionization** This can remove most harmful Metals present in water. The ions in the Water will be exchanged with the ions of the healthy water, forcing all the metals, and the compounds to be removed from the water.

#### 4. Zero-valent Iron Nanoparticles (Z.V.I.N)

These Z.V.I.N. are particles which are very reactive in nature and can be useful in on-site treatment of the water and air. These particles absorb all the organic compounds. These particles also absorb heavy metals. These particles also help in the removal of all the hydrophobic materials such as oils or fuels which can be harmful to humans.

Figure 3.3.3: ZVIN

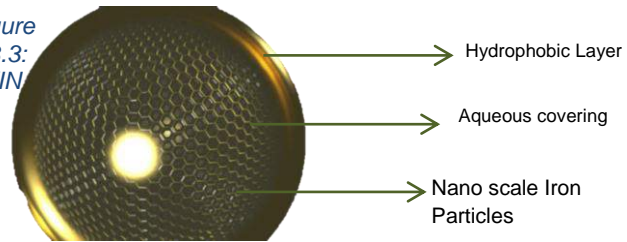

#### 5. Graphene and Acoustic Nanotube Technology

Graphene and Carbon Nanotubes are the two materials that can help a lot in water and air purification. The water enters the Carbon Nanotube and contacts the filter matrix made up of polymers or ceramic threads. Carbon Nanotubes in the filter matrix don't allow large molecules and contaminants to pass through the Carbon Nanotube. The technology uses acoustics to drive the water in the Carbon Nanotube.

#### 6. Trans-Membrane Chemi-Sorption

The Trans-Membrane Chemi-Sorption reacts the ammonium ion with the hydroxide ion with the reaction-

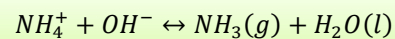

Then the ammonium from the water will be separated using the reaction

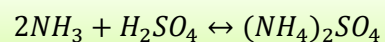

The Ammonium will be separated in order to make air. It will be sent to the agricultural torus where the air management system will produce air out of the Ammonium.

7. **RO** Reverse Osmosis will be used for the microbial disinfection of the water.
8. **UF** Ultra Filtration Technology can help to change the pH Level to 7 along with calcite. pH 7 means the water is neither acidic nor basic.
9. **UV disinfection** The Ultraviolet disinfection inactivates any viruses or bacterium.
10. **Taste and Odor Control** The taste and the odor of the water can be made natural after it crosses a bed of activated carbon layer which will be able to generate a natural taste rather than a bitter one.
11. **Water Softening Technology**

Soft Water is required for bathing and washing purposes. Cation Exchange will be used to soften the water. A TDS will be used to stop the salts from jamming the system.

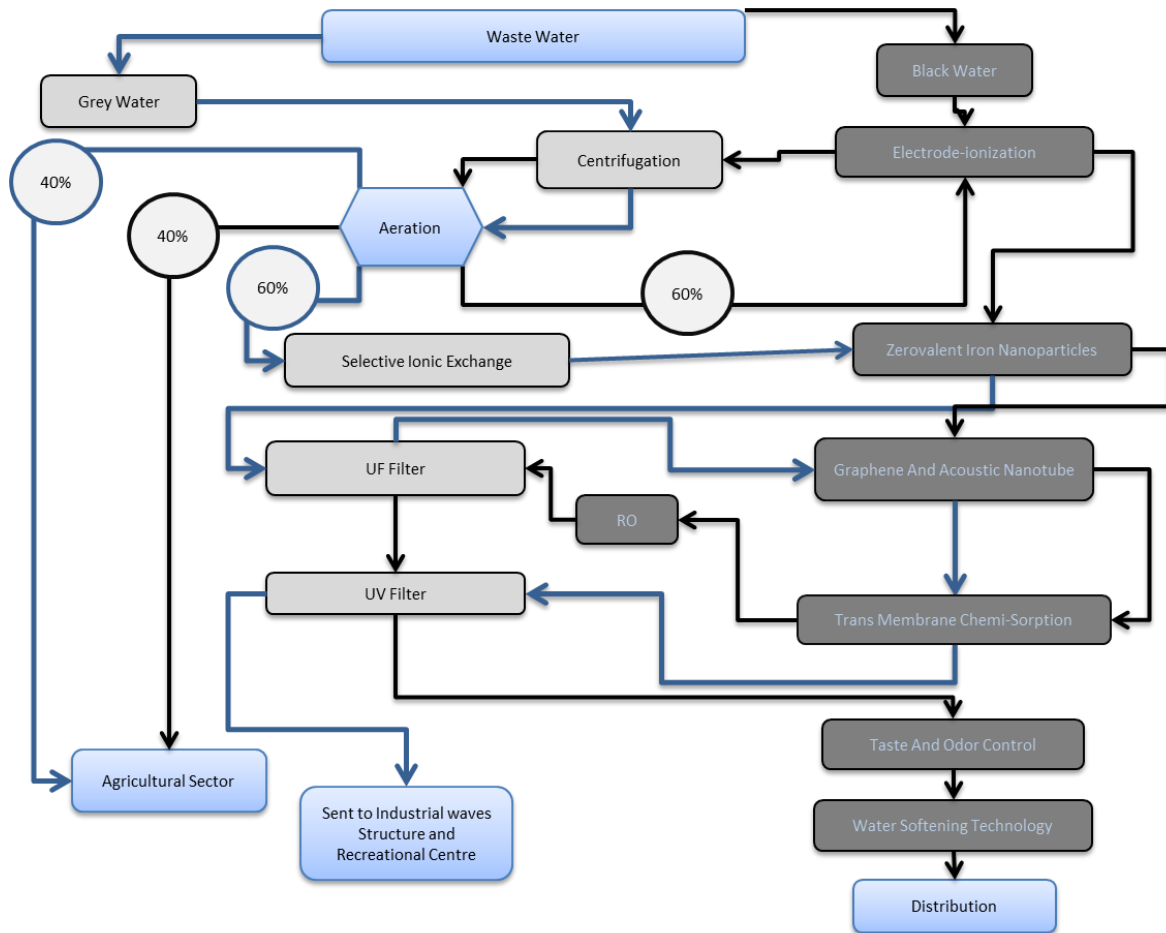

Figure 3.3.4: Water Recycling Process

### Water storage

Water will be stored in permanent tanks which will have inbuilt water heaters. These tanks will send the water to different areas as per the water requirement.



Figure 3.3.5: Water Storage Tank

- The spring shown in the figure will act as a scanner for viruses.
- This tank will approximately contain up to 510l of water and 12 of them will be installed in VONA in life support system zones.

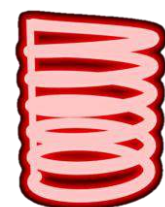

Figure 3.3.6: Water Heaters installed inside water storage tanks

## Water Distribution

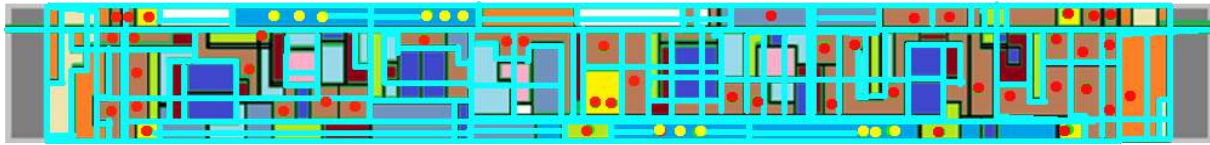

Figure 3.3.7: Layout of Water Pipes in Each colony of Residential Hybrid Torus

Water Ghost Pipes will be aligned in VONA.(Fig3.3.7)

## WASTE MANAGEMENT

### Waste produced

The waste produced in VONA will approximately be according to table 3.3.2

### Waste separation

Waste will be separated into its various subtypes using following processes

- Drum screens
- Eddy Current Separator
- Induction Sorting
- Near infrared sensors
- X-ray technology

This will separated the waste into liquid and solid categories.

### Organic and human waste

Human waste would be recycled by the following methods:

- The First step would involve separation of the waste water and solid waste
- Then the liquid waste will be sent to the fertilizer processor facility where it will be treated to obtain fertilizers sent further to the agricultural torus.
- While the liquid is processed the solid will be sent to the bio reactor where the solid waste is composted and sent to the agricultural torus.

### A network of Lotus



LEGEND of Water Pipes	
	Minor water storage tanks
	Major Water Storage
	Water pipeline

Table 3.3.2

Field	Total amount/day
Residential	0.83 kg
Industrial	20-30 kg*
Agriculture	0.24 kg *
Recreational	0.46 kg

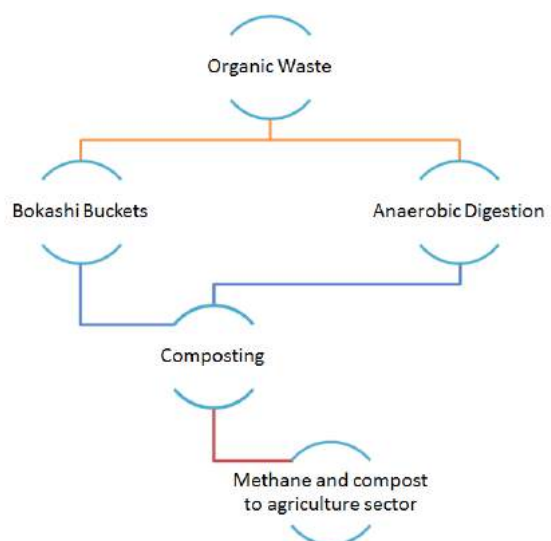

Figure 3.3.8: Organic and Human Waste Management

Ways to recycle Organic Waste:

- Organic waste will be sent to the Bokashi Buckets which contains the Bokashi Mix which includes grains and sawdust that would speed up the fermentation process and can be a good replacement to the ordinary organic dustbins and Vermi-Composting methods.
- Anaerobic Digestion involves microbial digestion of the solid, semi- solid and the liquid waste matter which involves converting a fraction of the waste to Carbon Dioxide and methane. Methane can be used as a fuel and the Carbon Dioxide will be sent to the agricultural torus.

### Plastic waste

Waste plastic will be collected from the homes and will be recycled and reused in VONA.

Way to recycle Plastic:

- Plasma Pyrolysis: In this process plastics are heated to very high temperatures in order to recover the re-usable plastic which is moulded to form desired shapes.
- Liquid Fuel: The leftover polymer liquid in plasma pyrolysis will be used as an alternative liquid fuel to power appliances.
- Polymer Blended Bitumen Roads: The bitumen processed from plasma pyrolysis can be used to make polymer roads in VONA in order to protect them from wear and tear and the heat produced by the friction of tyres of vehicles in VONA.
- Waste Plastic Bags will be sent to the polymer weaving loom to weave polymers in order to create carry bags, and other light accessories.

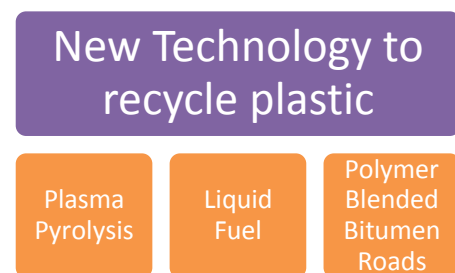

Figure 3.3.9 New Technology to recycle plastic

Alternative methods:

- Continuous Plastic Waste recycling machine: This machine recycles all type of common plastic and polymers along with rubber. It uses new technology to beat out the polymers in the plastic itself and moulds them into new shapes
- Agglomerator: Agglomerator is a patented device which can recycle up to 99 % of the plastic and retain its purity by 98%.

### E-Waste

Electronic Waste is the waste which is derived from the used electronic articles. E-Waste would be recycled so that the rarer materials used in these devices can be reused.

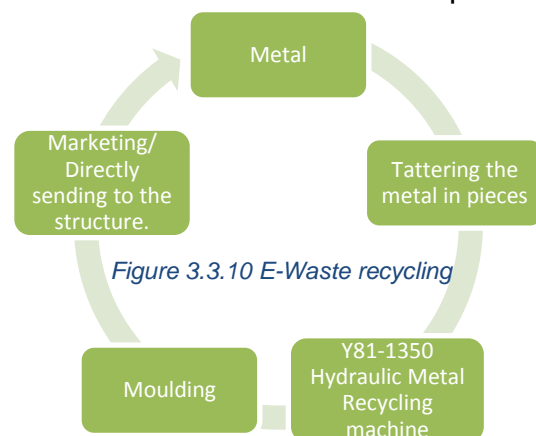

Figure 3.3.10 E-Waste recycling

- Electronic articles will be sent to the PCB (Polychlorinated Biphenyls) E-Waste Recycling Machine which crushes all the materials and uses technologies like eddy currents, screens, magnetism, X rays etc. in order to recycle the E Waste very efficiently.
- Metals like Aluminium, Steel, Copper, Chrome, Iron, etc. will also be recycled using Y81-1350 Hydraulic Metal Recycling machine which can recycle all the metals with 98% efficiency.
- This machine uses magnetic separation after the metal has been tattered into small pieces. Then the machine melts the metal to about 700°C and compresses it into different moulds accordingly.

## Glass

Before recycling the machine the glass will be sorted in to different types categorized by glass bottles, colours, slabs, etc.

- The additional materials like labels, plastic caps, metals will be removed from the glass
- Glass bottles would be recycled using Glass Bottle Recycling Machines which melts the bottles and moulds it into preset bottle shapes.
- The bulk glass or glass slabs will go to the Two Stage Crusher and Glass Recycling Machine which crushes the glass and recycle them using high temperatures so that the glass blocks are recycled fast with 99% purity.

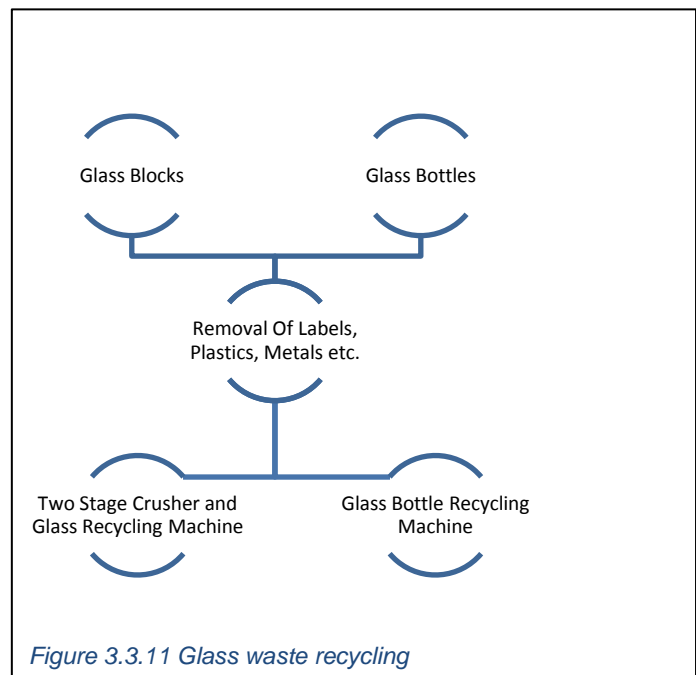

## PRIMARY PROCESSES

### Hyper EX Solar Cells

Hyper EX Solar Cells consist of Quantum dots constructed out of VACNT. In addition, each cell is coated with VACNT on the edges, increasing the

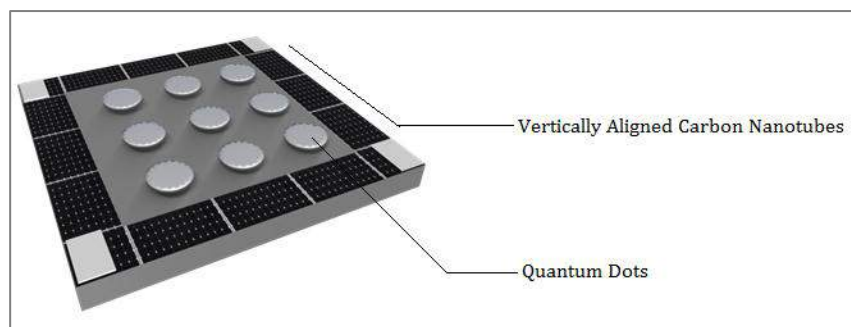

*Figure 3.4.1: Hyper EX solar cell structure*

surface area for capture of light. The Hyper EX Solar Cell captures 99.993% light and some invisible wavelengths. The Hyper Ex solar cells can be used to create highly efficient Solar panels. Also these will be coated on the spaces between two consecutive solar panel arrays. with a single molecular layer of lotus water ghost Hydro-phobic material which will prevent the dust particles from settling on the solar panels.

### Transparent Solar Cells

This is a type of solar cell which is not black but can still clock up to 70% efficient with same appearance as of glass. These Solar Cells will be used in the illumination windows of the Tori and Waves.

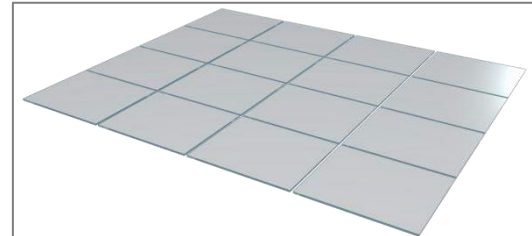

Figure 3.4.2: Transparent Solar cells

### Area Requirement

Table 3.4.1		
Name of the Cells	Total Area	Total Electricity per day
CQD Cells	1862526 m <sup>2</sup>	7301040 kW
Transparent Solar cells	1519526.52 m <sup>2</sup>	3039053.04 kW

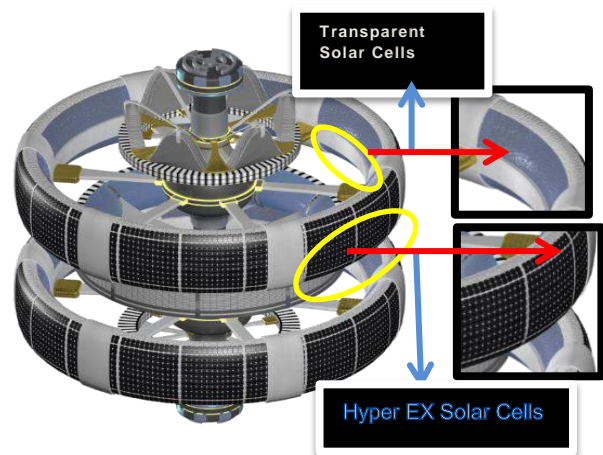

Figure 3.4.3: Layout of solar cells inside VONA

### Layout of the cells

Fig3.4.3 shows the layout of cells.

## SECONDARY PROCESSES

### Piezoelectric material derived from Poly-lactic Acids

These cells, more efficient than before, are made of a new material which is transparent as well as flexible. Alternate film lamination of isomers of Poly-D-Lactic Acid and Poly-L-Lactic Acid is used in making these types of cells. These cells can be achieved using Barium Titanate particles by introducing them in the cells in a transparent

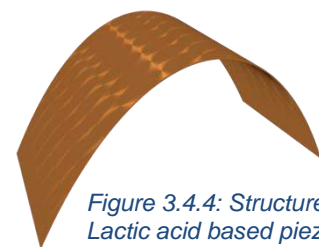

Figure 3.4.4: Structure of Poly-Lactic acid based piezoelectric cell

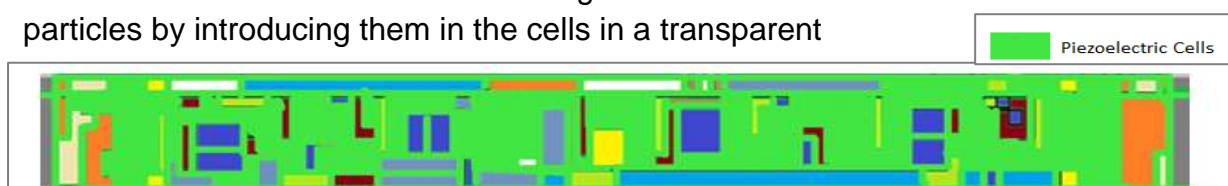

Figure 3.4.5: Layout of piezoelectric cells

medium. 70% of the interior will be laid down with these cells.

### Telluride Based Thermoelectric Cells

The heat produced inside the settlement (for example the heat produced by the sun rays falling on the illumination windows) will be converted into electricity using these cells with an efficiency of 50% to 60%.

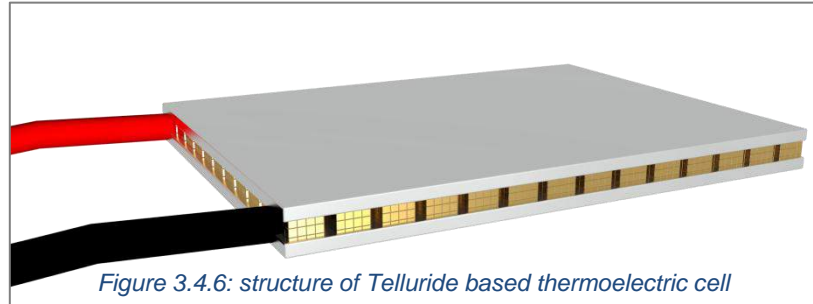

Figure 3.4.6: structure of Telluride based thermoelectric cell

### Copper Sulphide Nanoparticles and SWNT Based Hybrid Cells

These cells are made out of Copper Sulphide Nanoparticles and Single Walled Nanotube cells which absorb light as well as heat which is then converted into electricity. These cells capture 80% of light. But the efficiency can be increased using a molecular layer of vertically aligned carbon nanotube array. This can mean that the efficiency could be increased more than 95%.



Figure 3.4.7: Copper Sulphide nanoparticles and SWNT based Hybrid cell structure

### Economic Wind Turbines on the Martian base

Hybrid turbine: combining the designs of Honeywell and whale-power commercial windmills, the hybrid windmill have been designed which can easily capture 70% of the wind that crosses it. These will be used in the Martian base because there are high velocity winds blowing on the Martian surface.

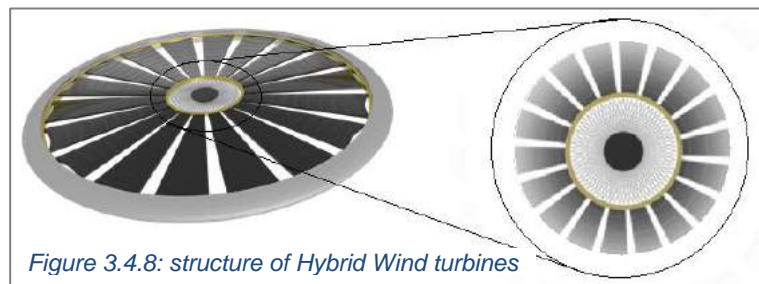
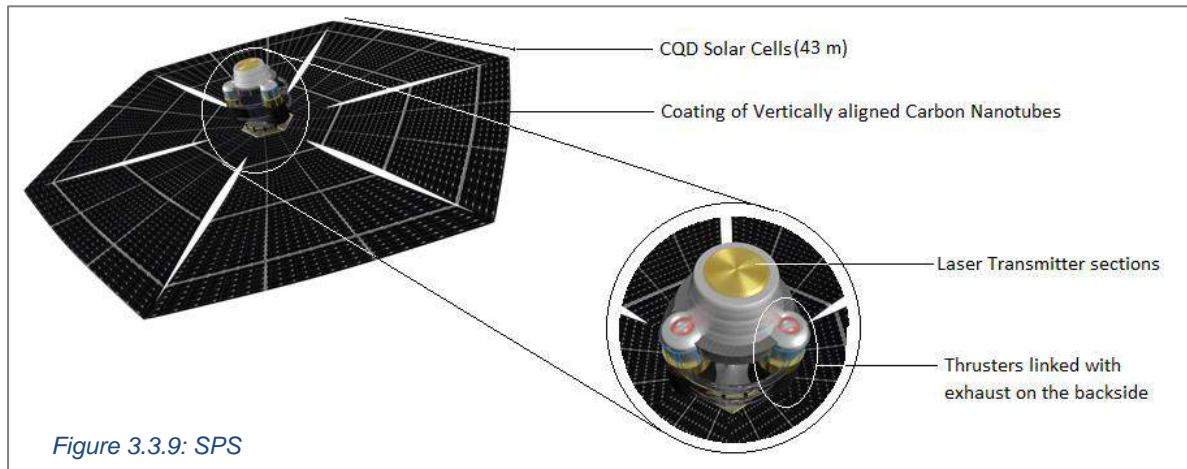

Figure 3.4.8: structure of Hybrid Wind turbines



## Solar Power Satellite

The solar power satellite will first be built in the geosynchronous orbit where it will



provide electricity for the initial stages of VONA. After the VONA is transferred to the Mars Areosynchronous orbit these will sell electricity to earth. A new series of these SPS will again be built in the Areosynchronous orbit while half of the SPS used in initial stages will be transferred to the settlement.

### BACKUP TECHNOLOGIES

The backup Technologies that will be used VONA will be batteries that will only be used when the entire primary or any of the secondary systems fail. The batteries used in the backup plans will be:

### Xenon Diflouride Batteries

Claimed to be “the most powerful non-nuclear energy storage ever”, this battery is the most efficient one made yet. This battery is made using highly compressed Xenon Diflouride and white crystals. When incorporated with water dipped graphite room temperature super

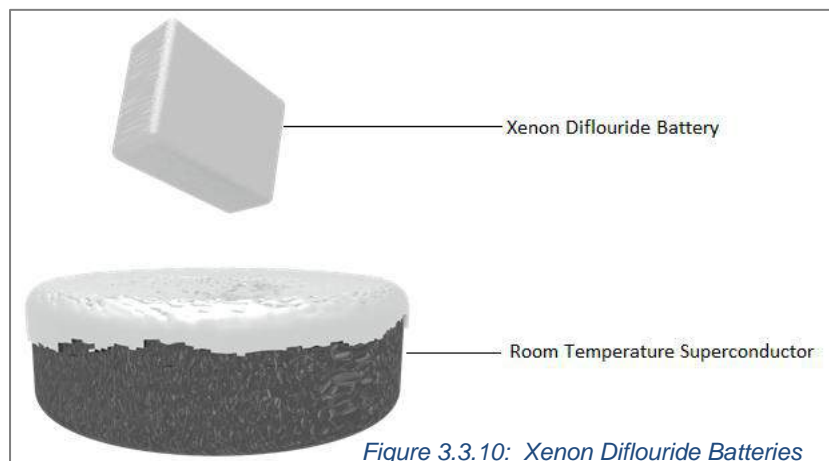

conductor, it can store massive amounts of energy.

Water Dipped Graphite room temperature superconductor can be achieved when the hydrogen atoms are subjected to the granular structures of graphite induced with hydrogen plasma. Each colony in VONA will have one grid each.

### STORAGE OF ELECTRICITY

VONA will have SMES storage system. This technology stores all the electricity in a magnetic superconductor coil which can store high amounts of energy

instantaneously. This type of grid has claimed to lose 1 volt in more than 50-60 years.

The system currently has 2 parts:

- Cryogenically cooled Superconductor
- Power conditioning system

The superconductor once charged will circulate electricity within itself to form an uninterrupted non-decaying grid with minimal resistance. This system can also handle critical loads of electricity.

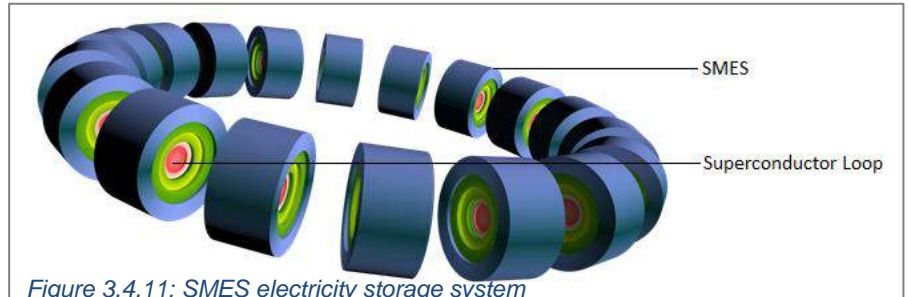

Figure 3.4.11: SMES electricity storage system

It has a high energy recovery. This technology can also help in the Electromagnetic resonance transmission in the power grid.

Purpose	Kilowatts Consumed [per 10000 people]
Residential	25000
Industrial	30000
Lighting	32000
Water Management	12000
Agriculture	25000
Industrial	108000
Backup	309000
Total	417000

We can improve SMES system by introducing room water dipped graphite.

### Transmission

Electricity will be transmitted inside VONA using electromagnetic resonance. This technology helps to transmit electricity without any wires or other old technologies.

The new technology also known as Evanescent Wave Coupling is based on the principle of electromagnetic induction. But in order to make the transmission efficient Resonance Waves have been introduced in the technology. This specifically “tunnels” the field to another coil similarly resonating at the same frequency. Analysis shows that by transmitting electromagnetic waves in a particular pattern evanescent waves could be achieved. If the pattern is repeated near a transmitter the evanescent waves then guide the electrons of the transmitter in the same pattern so as to get rectified into Direct Current.

Figure 3.4.12: electrical transmission process

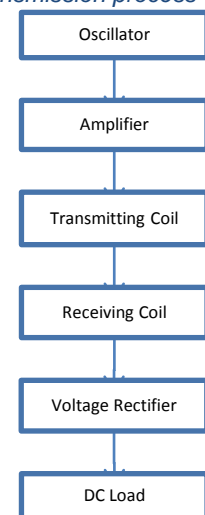

### Layout

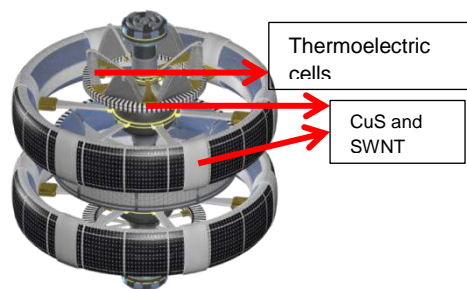

Figure 3.4.13: Layout of Thermoelectric and Hybrid cells

Table 3.4.3 Electricity Generated Using Various Techniques

Type	Total Area	Total Electricity/person
Piezoelectric cells	561570.9 86 m <sup>2</sup>	673885.16 kW
Thermoelectric Cells	531895.9 m <sup>2</sup>	638275.08 Kw
Hybrid Cells	448836 m <sup>2</sup>	4039524 kW

As food is a very essential part as it sustains human life, providing food to the inhabitants of VONA according to their nutritional requirements will be very

Table 3.5.1

Crops and vegetables Grown	Consumption (gram/person/day)	Total quantity used (kg/day)
Wheat	230	3818
Maize	70	1162
Rice	150	2490
Peas	80	1328
Potato	130	2158
Lettuce	100	1660
Spinach	90	1494
Carrot	50	830
Tomato	100	1660
Cauliflower	90	1494
Garlic	10	166
Sugarcane	130	2158
Tea	7	116.2
Pulses	150	2490
Oats	60	996
Mushrooms	30	498
Onion	70	1162
Coffee	9	149.4
Broccoli	40	664
Cabbage	40	664
Cucumber	50	830
Radish	30	498
Chillies	40	664
Peppers	20	332

important. The agricultural torus in VONA will be completely devoted in providing the food to the inhabitants of VONA. Table 3.5.1 shows the crops which will be grown inside the agricultural torus, which is further divided into 9 pirasos:-

inhabitants of VONA according to their nutritional requirements will be very

Table 3.5.1 continued

Crops grown	Total quantity used (kg/month)
Rosemary	50
Aloe	50
Sunflower	500
Coriander	80
Mustard	300
Olives	500
Coconuts	400
Soya beans	300
Groundnut	300
Beans	70
Sweet potato	80
Fodder for animals	1000

Fruits grown	Consumption (kg/person/week)	Total quantity used (kg/week)
Apple	1.2	19920
Grapes	0.5	8300
Banana	0.7	11620
Orange	1.1	18260
Mango	1.4	23240
Cherry	0.5	8300
Watermelon	0.7	11620
Papaya	0.4	6640
Lemon	0.5	8300
Kiwi	0.4	6640
Strawberry	0.5	8300
Peanut	0.12	1992
Peaches	0.7	11620
Pumpkins	1	16600
Almonds	0.25	4150
Hazelnuts	0.18	2988

In the drip system, the water with nutrient solution is held in a reservoir. A pump will periodically push the solution into the pipes which will flow into the pots over the reservoir. A smaller system of pipes will also drain the excessive solution back into the reservoir where it will be reused.

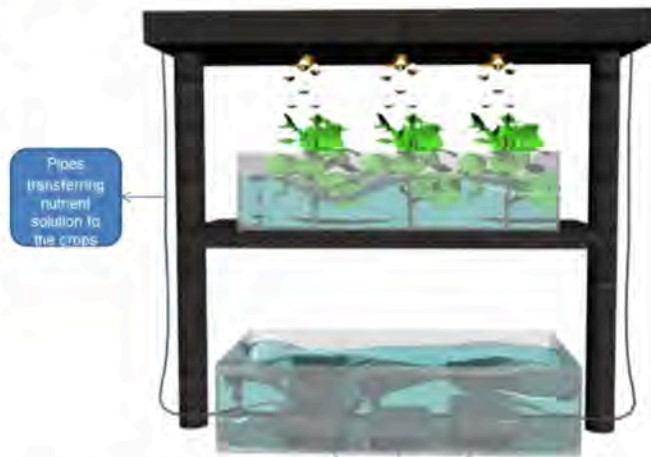
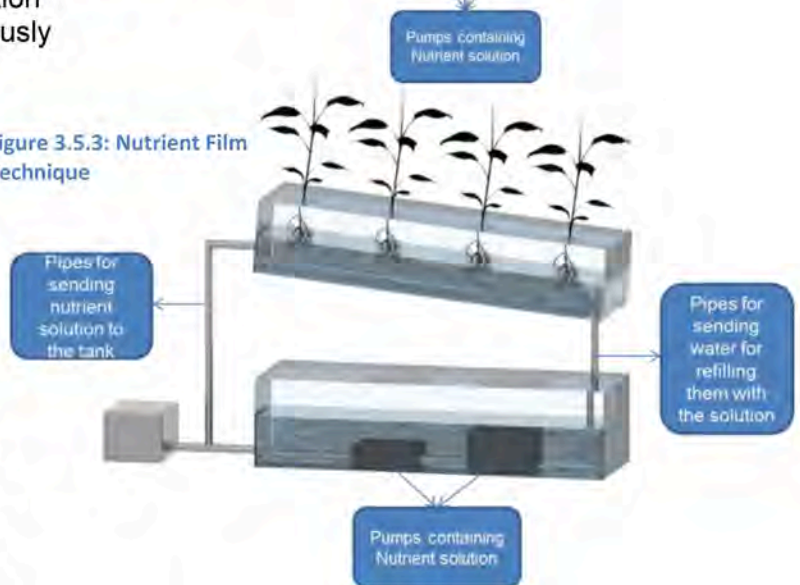

Figure 3.5.2: Hydroponics Drip System

### Nutrient Film Technique

The plants are placed above the nutrient solution in a tank in which only the roots of the plants are dipped. This solution inside the tank will be continuously flowing into it by a nutrient pump. There will be a nutrition detector; if nutrients are found in a lesser quantity, then this nutrition detector will send signal. The hydroponics method can be used to grow any flowering plants, vegetables, fruits and herbs which are used for seasoning and health purposes.

Figure 3.5.3: Nutrient Film Technique



## ANIMAL HUSBANDRY

- Cows (Jersey Cow) and Buffaloes (Murrah)** Cows will be living in the residential Hybrid torus which. The fodder for cows and buffaloes is barley, dry hay, wheat, oats, millets and protein cakes. Average water used by a cow is around 25-30l a day.
- Sheep and goats** The preferable season for these animals is the winter season with temperature ranging between 10°C to 20°C. Their food requirements are mainly maize, barley, dry hay and fodder biscuits. They do not require large amounts of water but a ewe requires water almost all the time.
- Poultry birds** The preferable season for these birds is the spring season, with temperature ranging from 20°C to 30°C. Their fodder consists of maize, rice, wheat bran and other protein rich feeds.

The reproduction of all these animals will not be done in the traditional way but it will be done by artificial insemination.

Table showing number of animals in the agricultural torus:-

Table 3.5.3 Number of Animals	
Animals	Number
Cows (Jersey Cows)	700
Buffaloes (Murrah)	80
Sheep	200
Goat	100
Poultry birds	300

### Meat production

For meeting the meat requirements of the people living in VONA, in-vitro meat will be produced. In the production of in-vitro meat, cells from the animals whose meat is to be produced will be taken and then they will be cultured and grown inside a bioreactor. In-Vitro meat is mainly made up of

## GROWING

For growing plants, the techniques used in VONA are:-

### Zeoponics

Zeoponics is a system of cultivation of plants with the help of artificial soil made of nafion, which has zeolites inside it. Plants grown using this technique are wheat, pulses, maize, fruit trees and nuts. Constituents of artificial soil:-

The artificial soil would be composed of nafion along with which non-toxic polymeric gel (formed by missing polyacrylamide co-polymer and water). Additionally, zeolites would also be added.

### Irrigation

To produce a better crop, we would irrigate the plants. Using these methods would use a minimum amount of energy. The methods are given in Table 3.5.2

**Table 3.5.2 Irrigation Systems**

Irrigation process	Explanation of techniques used
<b>Sprinkler Irrigation</b>	Water will be sprayed over the crop. Water is saved between 25-50% from crop to crop.
<b>Micro Irrigation</b>	Decreases 75% of water wastage. Water is applied to the crop area near the root zone.
<b>Bubbler Irrigation</b>	Reduces energy requirement and uses inexpensive pipe system and efficiently throws water to a distance of 5m, in all the directions.

### Aeroponics

Crops with hard roots will be grown on a mesh like structure hung vertically. Water will be converted into mist which will fill the chamber in which the roots of the plant will be hanging in. The plants that can be grown using Aeroponics are wheat, corn, potatoes and salad components like lettuce, herb etc.

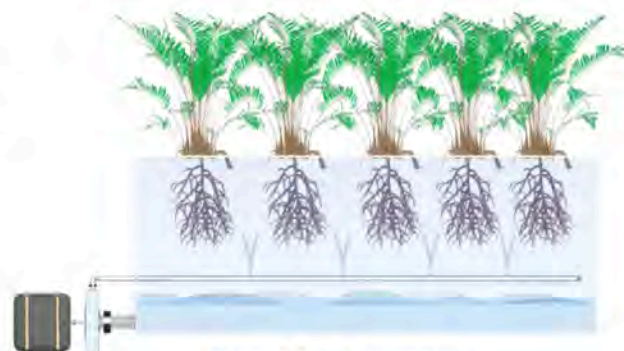

Figure 3.5.1: Aeroponics

### Hydroponics

In this method, plants are grown in a concentrated solution or an inert medium like perlite, gravel etc. Types of hydroponics used in VONA:-

#### Hydroponic Drip System

For packaging, the harvested crops and vegetables will be sent to the following units:-

- a. **Vacuumed packaging unit**- The food will be packed in sealed vacuum containers in order to stop growth of bacteria on the food.
- b. **Testing unit** - A unit for testing the packaging will be created in order to check for holes and other defects.

### **AGRICULTURE DEPENDENT INDUSTRIES**

Agriculture will also provide its produce as raw materials to different industries like the rubber industry, cotton industry and food processing industry which will make different food products for both the citizens and the animals.

### **STORAGE**

The grains will be stored according to their seeds or crop type. Grains will be stored in ventilated, dry areas, so that there are less chances of diseases. For fruits and vegetables cold storage areas will be at their place. Also there will be local and other small markets where these will be sold and they will have the fixed price for selling. The grains will be stored in silos having different partitions at different levels, increasing productivity. The stack will have the most required grain at lower end while least required but important at top. There will be no contact of each crop yield.

Earthworms are the manurists that convert the decaying plant material into nutrient rich manure though less rich than fertilisers but more efficient. Birds and butterflies are the major pollinators also there will be artificial pollination APS. In this pollen grains will be transmitted to a plant via robots.

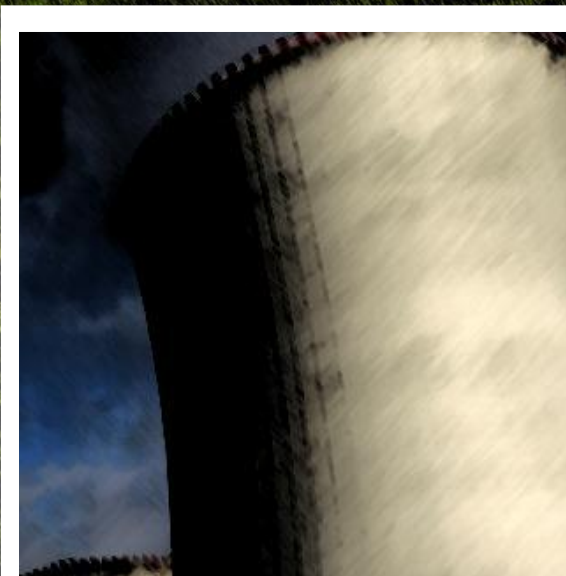
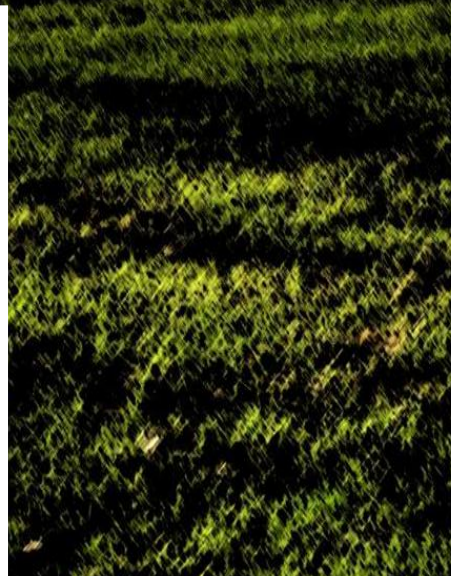
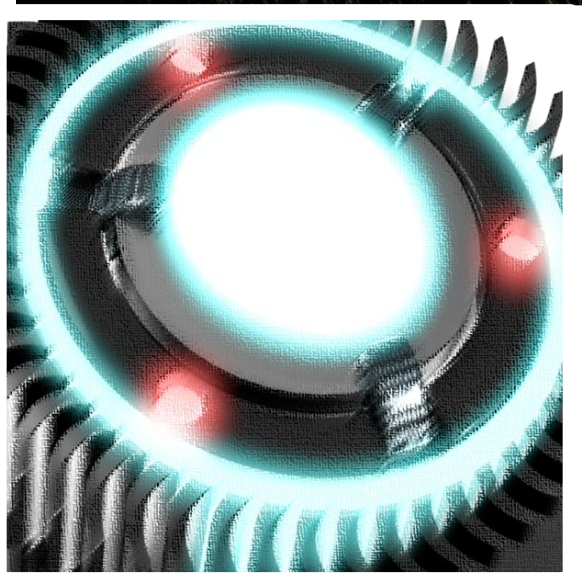

# SECTION 4.0 OPERATIONS & INFRASTRUCTURE

SECTION 4.0 OPERATIONS & INFRASTRUCTURE

*“As far as we can discern, the sole purpose of human existence is to kindle a light in the darkness of mere being.” ---- Carl Jung*

## INTRODUCTION

Illumination would play an important role in simulating the conditions of earth on VONA. The reflectors used to illuminate VONA are:

### Primary reflectors

The Primary Reflectors in VONA are constructed out of Biaxially-Oriented-Polyethylene-Terephthalate or BoPET which has high tensile strength, great chemical stability. Metallized BoPET (Also known as Mylar) is one of the most reflective types of material and reflects more than 98% of the light that is projected on it.

### Mylar

Metalized BoPET coated with aluminum is also known as Mylar. Mylar as mentioned can reflect 98% of the light projected on it. Coating the back side of the Mylar with Tantalum Hafnium Compound may increase the total melting point of the Mylar along with decrease the use of thrusters used to stabilize the Reflectors.

### Secondary Reflectors

#### Risley Prism

The Secondary Reflectors that will be used in VONA are Risley Prisms which are made up of different layers so that the light can be reflected in a desired angle. The Risley Prisms work in pairs along a hydraulic or pneumatic system for example; to send the light straight we can rotate 1 prism 90°.

This technique will enable us to rotate the

Figure 4.1.1 Mechanism of Illumination

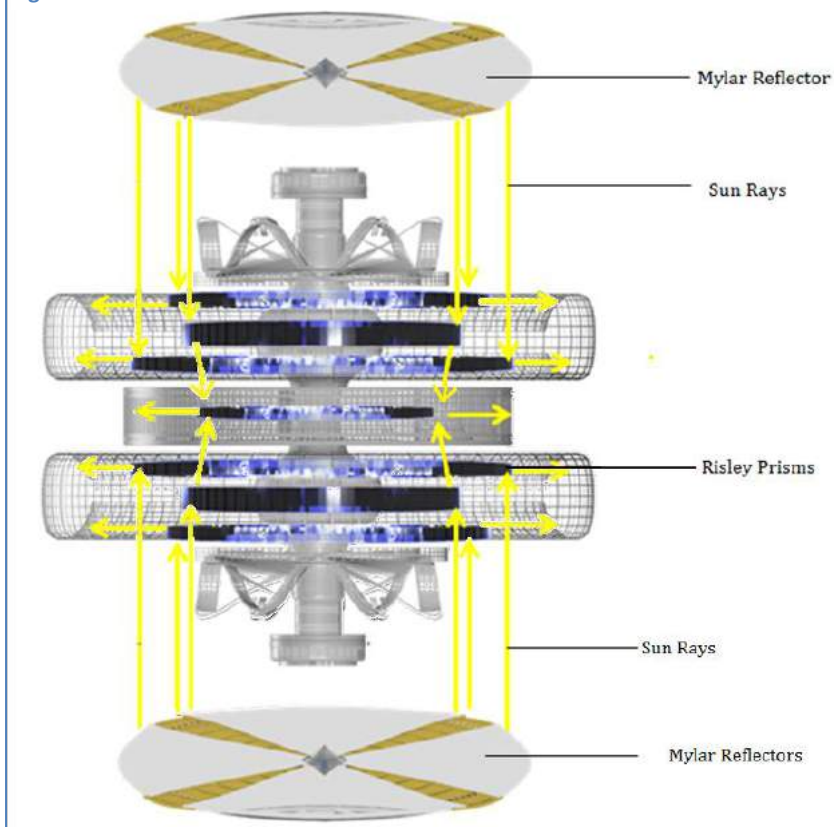



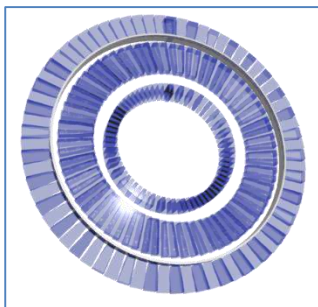

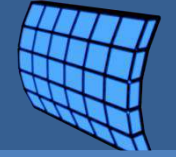
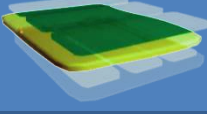
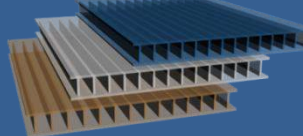
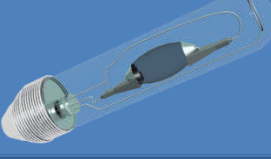
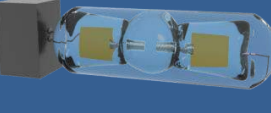

Figure 4.1.2 Risley Prism

prisms in the desired angle to reflect the light beams to the tori. Multiple prisms will be attached to the prism ring in order to illuminate the various areas. The arrangement of the illumination ring is shown along with the diagram VONA

### ARTIFICIAL LIGHTING

The provisions of artificial lighting are given in Table 4.1.1

Table 4.1.1 Provisions of Artificial Lighting	
Provision	Explanation
<b>LUXIM® Plasma Bulb</b>	This Plasma Bulb from the Company Luxim® is extremely energy efficient as well as produces immense amounts of light i.e. 140 lumens per watt. 
<b>Stacked Organic LED's</b>	They are eco-friendly lights that produce about 90-100 Lumens per watt. 
<b>Transparent Organic LED'S</b>	These are transparent LEDs to prevent total darkness at the time when Smart glass is switched off. 
<b>Polycarbon Lexan Sheets</b>	These sheets change the color of the light to make the people feel for simulation of earth like atmosphere 
<b>Metal Halide Lamp</b>	These are Metal Halide Lamps which can produce 120 lumens per watt. These will be used in recreational center 
<b>Halogen Metal Iodide</b>	These metal Halide Lamp produce 5600 K light which is the same as of normal Daylight. They will be used for the illumination of industrial waves structure. 

### DAY AND NIGHT CYCLE

The Day and Night Cycle will be extremely important for settling people for long periods of time as it may help the rhythmic patterns of day and night as on Earth.

## Smart Glass

The Smart Glass used in VONA is SPD Smart Glass which is very flexible in terms of controlling the total light, heat and glare passing through the windows. When the Smart Glass is switched “ON”, it will allow light to pass through. Switching off the Smart Glass can enable the particles to randomly take place which can block up to 99.4% of light. Electromagnetic Resonance will enable the Smart Glass to be powered on or off remotely anywhere.

Name of the Season	Duration of Day	Duration of Night
Spring	13 Hours	11 Hours
Summer	15 Hours	9 Hours
Monsoon	14 Hours	10 Hours
Winter	11 Hours	13 Hours

Table 4.1.2 Day & Night Cycle

### TYPES OF RADIATION

Outside of earth’s Ozone protection anything bigger than an atom can be dangerous. The types of radiation that would have to be blocked in VONA are:-

- Neutron Radiation: This type of radiation consists of radiation with completely free neutrons.
- Cosmic Radiation: Cosmic Radiation has extremely high energy and also is highly penetrative. The Cosmic Radiations are of 2 types :
  - I. Galactic Cosmic Rays(GCR)
  - II. Solar Cosmic Rays(SCR)

As, many of these radiations are harmful for the human beings, we need to protect VONA by blocking these radiations so that they do not enter VONA

- X-ray and Gamma Radiation

### Materials Used for protection

#### Illuminated Areas

The materials used for the illuminated or transparent areas will be:

The first layer will be made out of Lunar Glass. The layer below it will be made out of Palladium Based Metallic Glass followed by Silica Aerogel which is light, transparent and absorbs radiation very well and Lead Glass. Subsequent layers would be made out of RXF1, Transparent Aluminum and Diamond Aerogel the final layer will be of Electro chromic Smart glass.

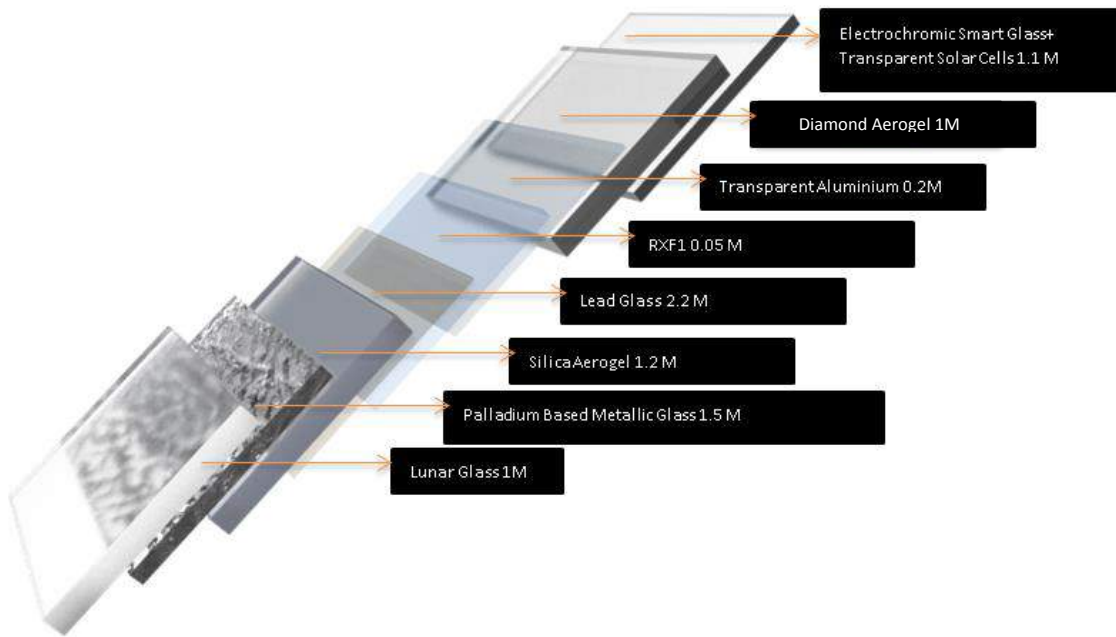

Figure 4.2.1 Tiling of Illumination Windows

## Non-Illuminated Areas

The non-illuminated areas will be covered with Graded z Shield to protect from almost all types of ionizing radiations. The layer 1: Copper, Tin, Tantalum and Lead.

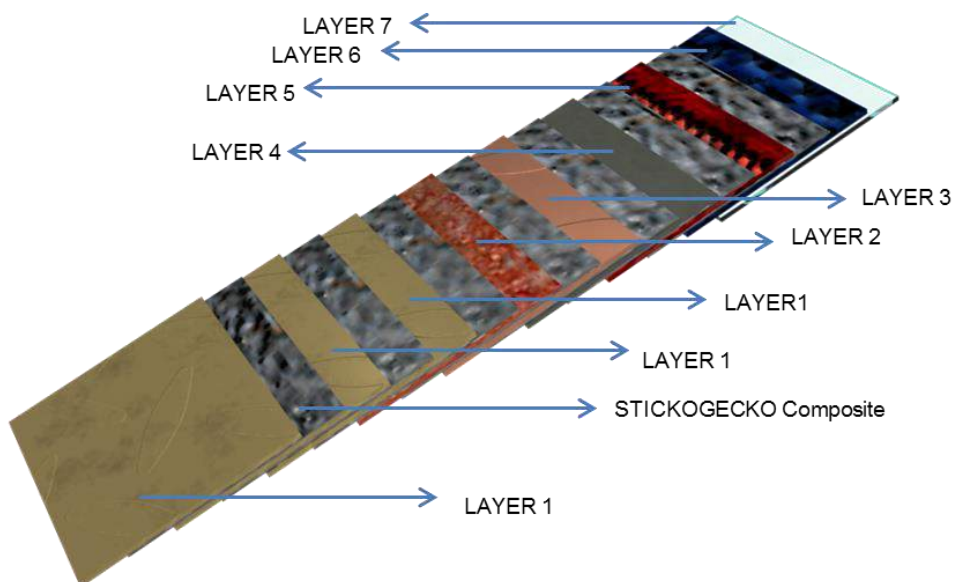

Figure 4.2.2 Graded Z Layering

3 layers will be made out of LAYER 1.Layer 2: Super Adobe and Aluminium Oxynitride. Layer 3 Tin, Steel and Lead. Layer 4: Aluminium. Layer 5: All of these layers will be set on Beta and Kapton cloth. Layer 6: Lotus water ghost. Layer 7: hard water.

## Protection at the Docks

But all around the structure there are openings to radiation like docks. But here artificial electromagnetic radiation will be produced using machines in order to counter all the ionizing radiations so that the docks will be undisturbed by the radiation.

### MONITORING RADIATION:

Monitoring of radiation is done as follow:

- External exposure monitoring refers to measuring Radiation levels in and around work areas, and other areas as well.
- Radiation monitoring is carried out to access workplace conditions and individual exposures, to ensure acceptably safe and satisfactory radiological conditions in the workplace and to keep records of monitoring.

## Devices for Monitoring Radiation

### Geiger-Mueller Tube

This is a tube which when provided with an electric current can interact with the wall of the tube and interacts with gas as well. This produces a pulse which can be detected after it has been converted into readings like detections per minute.

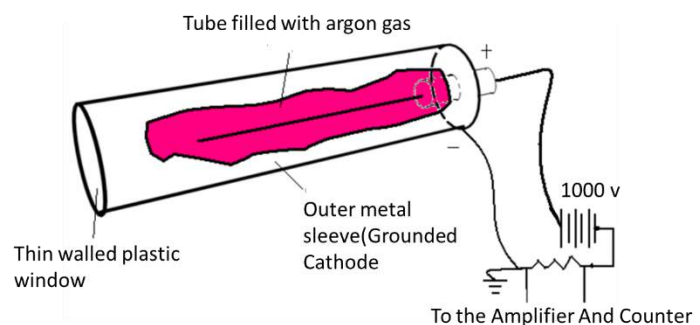

Figure 4.2.3 Geiger-Mueller Tube

### Neutron REM meter

This works similar to the Geiger Mueller Tube but can also detect the neutron radiation. This works when helium-3 tube which when supplied with a high voltage can generate an electric pulse which can be picked by Multi channel analyzer system which can even detect neutrons and gamma particles.



Figure 4.2.4 Solid State Detector

**Solid State Detectors** Solid State Detectors can be used to find out the

concentration of particles. This is done using a semi-conductor material which can give out electric pulse once in contact with the ionizing radiations. Cadmium Zinc Telluride can be used as the detection material for the detectors.

## Layout of detectors

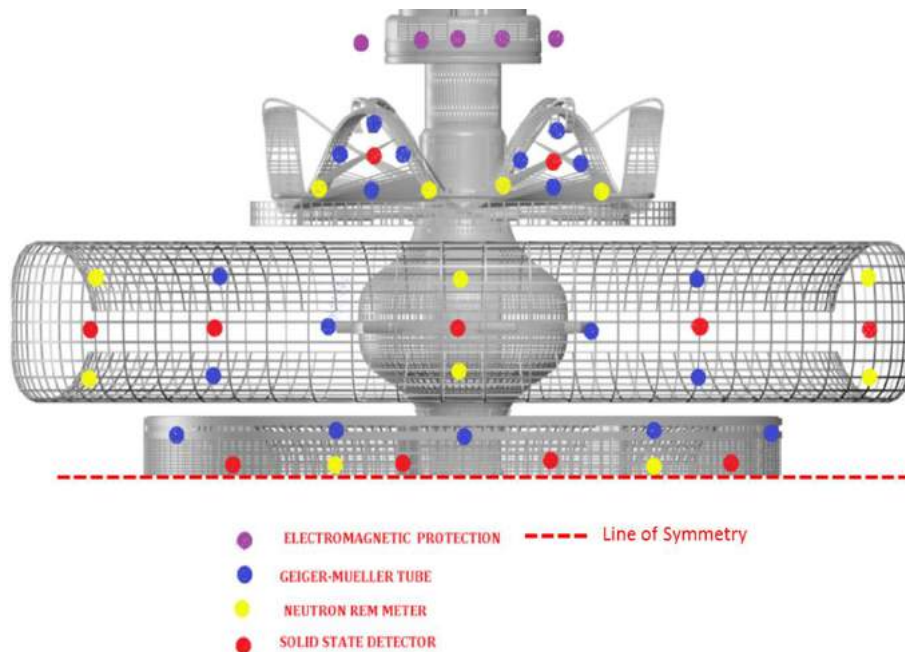

Figure 4.2.5 Radiation Protection Units

Transportation plays a vital role in the functioning and the development of **VONA** as it facilitates and enhances all other activities and construction of the settlement and the Martian/Lunar bases.

### INTERNAL TRANSPORTATION

Internal transportation plays an important role in determining the way in which residents, researchers as well as cargo, machinery and construction materials are transported all around and inside various components of the structure.

### Transportation in Residential Hybrid Torus

Transportation in the residential hybrid torus will be carried out using the following vehicles given in table 4.3

Table 4.3.1 Transportation vehicles in residential HYBRID torus

Name Of Transport	Top Speed	Capacity (at one time)	Purpose
Harmony	20 km/h	3 persons	For very short distances.
Electric Cars	35km/h	4-5 persons	Family vehicle
Mono Rails	45km/h	70 persons/car	For long distances within a torus.
Moving Sidewalk	0.5 m/s	Depends upon the size.	Used in markets

### 1. Harmony

Harmony will be used by the residents of VONA for short-distance movement. It is a three seated vehicle. It moves on 2 wheels each having a separate motor which works on fuel cells and has a maximum speed this is 20 km/h. It has a navigation control system which takes commands from the user.

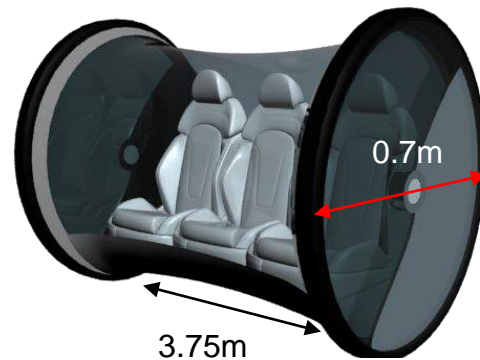
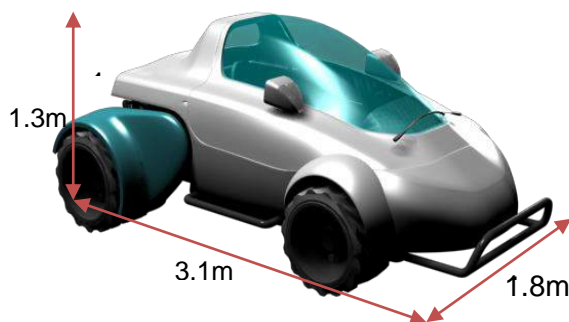

Figure 4.3.1 Harmony



### 2. Electric Cars

Electric Cars will be used by the residents to travel short as well as long distances. The maximum speed of this vehicle will be 35km/h.

Figure 4.3.2 Electric car

### 3. Mono Rails

These trains will run through stations located at different parts of VONA and will help in the transportation of goods as well. These trains will have 4 to 6 coaches, and each having a capacity 50 to 70 people at a time and would be able to travel at a max speed of about 45km/h.

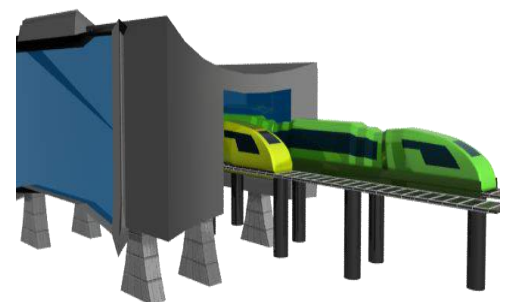

Figure 4.3.3 Mono Rails

### 4. Moving Sidewalk

Moving has a motor-driven chain of linked plates which move in a particular direction. These plates move at a very low speed of 2.196km/hr.

## Transportation through the Central Axis

Internal transportation is not limited to the residential torus but also has to be carried out to and from the docking port, the central hub etc. Accordingly VONA has three types of elevators running throughout its structure. Table 4.4

Table 4.3.2 Elevators

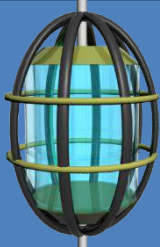
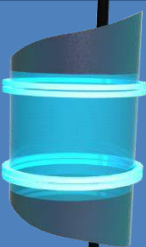
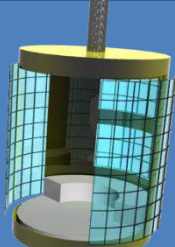
Features	Passenger Elevator(Fig 4.3.5)	High Speed Elevator(Fig 4.3.6)	Cargo Elevator (Fig 4.3.6)
PURPOSE:	These are for the everyday use of the residents.	These are exclusively for the Staff so that they can quickly move around the structure.	This will be used for moving goods, machinery and other cargo materials throughout VONA
Speed:	7 m/s	10 m/s	6 m/s
Capacity:	6-8 persons	6-8 persons	5000 kg of storage
			
	Figure 4.3.4	Figure 4.3.5	Figure 4.3.6

There will be different routes that these elevators will be following as shown in Fig 4.3.8

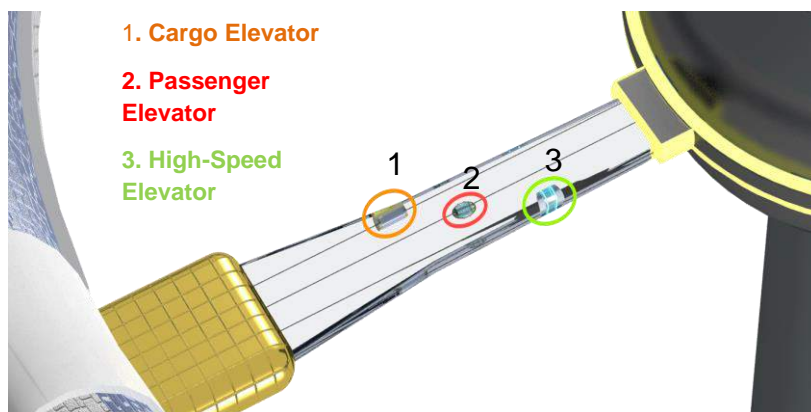
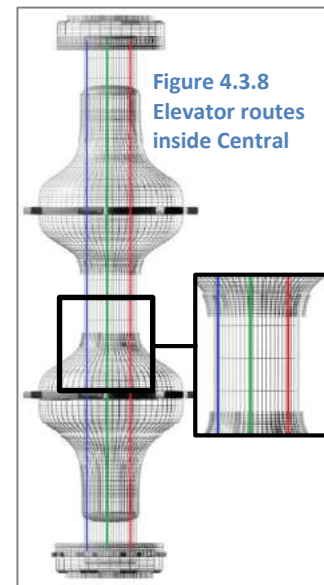

Figure 4.3.7 Elevator routes



## EXTERNAL TRANSPORTATION

External Transportation includes the movement of people and goods to and from the settlement, earth, moon etc. All the methods used in

## External Transportation Route

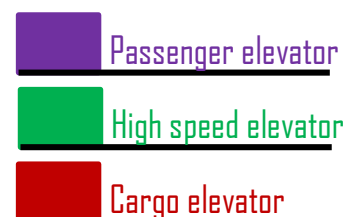

The missions of every ship are discussed in table 4.5

Table 4.3.3 Transportation Routes

Vehicle	Routes/ Missions	Distance
1. Express-Way:	a. Earth - VONA	a. 61,571,641.5 km
	b. Earth – Mars	b. 56,000,000 km
2.Kratos:	a. Earth – VONA	a. 61,571,641.5 km
	b. Earth – Moon	b. 363,300 km
3.Optimus:	a. VONA - Moon	a. 7,99,79,525 km
	b. VONA – Phobos	b. 10,768 km
	c. Moon – Mars	c. 8,00,00,000 km
	d. Mars - Deimos	d. 23,460 km
4. Star-Scream:	a. Earth – Mars	a. 56,000,000 km
	b. VONA – Mars	b. 20,475 km
	c. VONA – Deimos	c. 31,201.728
	d. Moon – Mars	d. 8,00,00,000 km
	e. Mars - Phobos	e. 5970 km (approx.)

### Vehicles used in External Transportation

The vehicles which are used in VONA are discussed in table 4.3.4

Name of transport	Purpose	Engines
Express Way	Transfer of people, goods etc. to VONA from earth.	1. VASIMR
Kratos	It will be used to carry passengers as well as industrial goods	1. Fusion 2.VASIMR
Star-scream	Transportation of cargo	1.Plasma Gun 2.MPD
Optimus	Transportation of cargo	1. Plasma Gun
Evacuation Pods	For evacuation of people from VONA in case of accident.	1.VASIMR

Table 4.3.4 Vehicles for External Transportation

Name of transport	Type	Speed	Capacity	Storage capacity
Express Way	Passenger and goods transport	50 km/s	650 – 700 passengers	30 tones
Kratos	Passenger as well as cargo	157 km/s (max)	700-1000 passengers	45 tones
Star-scream	Cargo	150 km/s	20 passengers	120 tones
Optimus	Cargo	100 km/s	15 passengers	70 tones
Evacuation Pods	Passenger	22 km/s	50 passengers	-no storage-



## Express Way

Express Way is mainly used for transportation of goods as well as transporting humans from earth to VONA

Express Way can accommodate 650 to 700 passengers at a time and carry 30 tons of cargo. It uses VASIMR technology to travel at a speed of 50km/s.

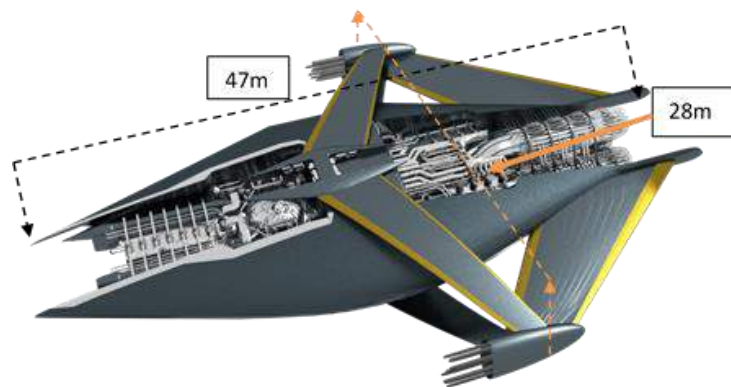

Figure 4.3.9 Express way

## Kratos

Kratos is also a passenger-cum-cargo space craft. It will use the fusion of Deuterium + Helium 3 i.e. Helium4 as a propellant and after crossing the gravitation pull of the earth it will use VASIMR for rest of its journey. The Helium4 engine gives a potential exhaust velocity of about 157 km/s. It has about 45 tons of storage capacity and can accommodate 700-1000 passengers in a single journey.

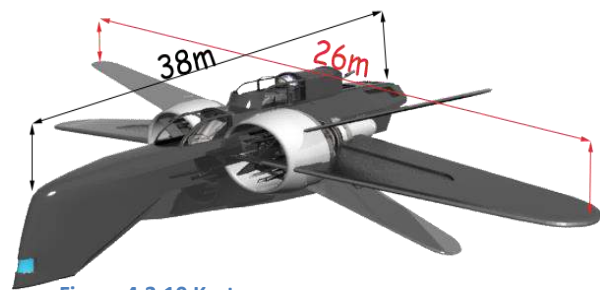

Figure 4.3.10 Kratos

## Star-Scream

Star-Scream is a cargo vehicle which will extract materials and transport them to different bases. Star-Scream will work on Plasma Gun (MCG) which provides a speed of 150 km/s. It also uses MPD thruster for

increasing its speed. It has a storage capacity of about 120 tones and has a space for 20 people. Moreover Star-Scream will have some stored mining machines as its basic function is that of extraction of the resources.

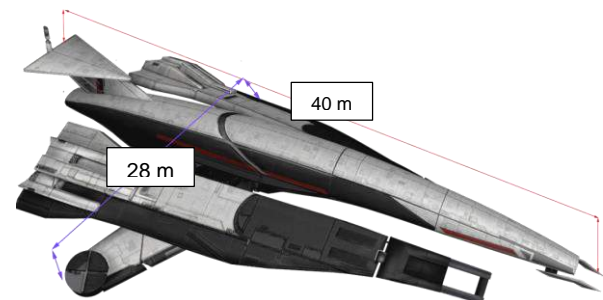

Figure 4.3.11 Star-Scream

## Optimus

Optimus is also a cargo vehicle working on Plasma Gun (MCG) propulsion with a storage capacity of about 70 tones and space for 15 people. Unlike Star-Scream it doesn't support mining machines.



Figure 4.3.12 Optimus

### Evacuation PODs

Evacuation pods are evacuation of residents away from VONA in case a disaster strikes it. In such situations, the evacuation pods, after securing the passengers will start its journey towards Earth. Evacuation pods will also be installed on Martian and Lunar bases. Evacuation needs high speed vehicle. For this purpose, pods utilize VASIMR technology which gives speeds up to 50 km/s. Their structure consists of padded base, head support, body straps and smooth IPC based underside that allow easy locomotion at such speeds

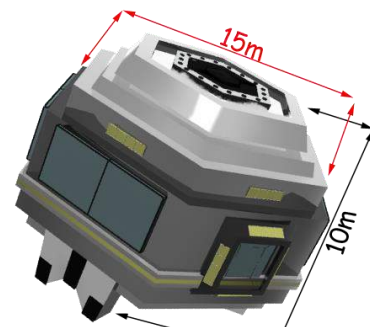

Figure 4.3.13 Evacuation PODs

*“All work and no play makes Jack a dull boy.”*

### RECREATION ZONE

Recreation plays an important role in our daily lives. To break away from the monotony of everyday work, we need recreation. The recreation zone in VONA consists of one uniform and 2 non uniform recreational divisions inside the recreation center. Rest of the space is utilized for research.

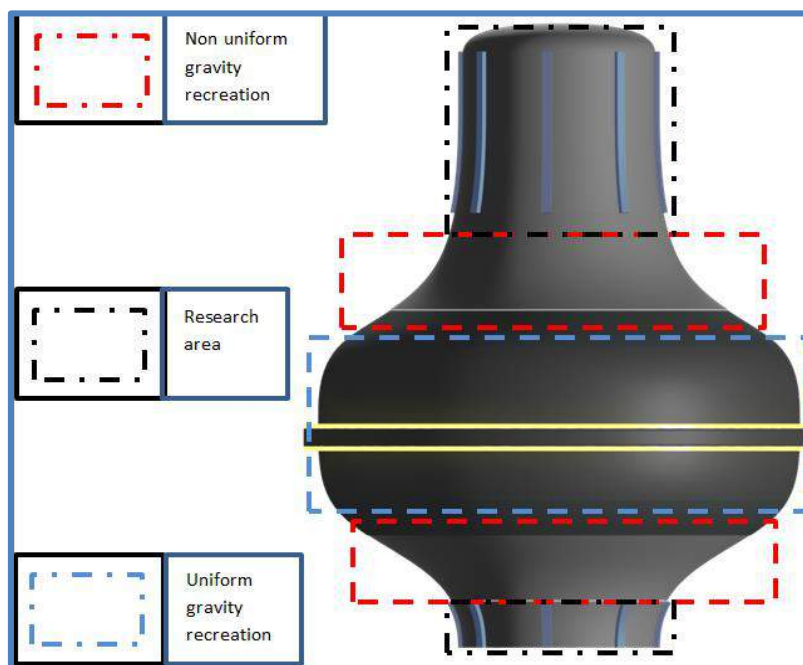

Figure 4.4.1 Recreation Centre

## RECREATIONAL ACTIVITIES

Recreation Activities in the  
Recreational center:

### Omni Directional Treadmill

Omni-Directional treadmill is basically a virtual reality based simulator that requires the user to wear virtual reality glasses. There is a large treadmill that can move in any direction depending upon the apparent direction in which the user wishes to move. Using virtual reality glasses, several environments can be generated. The output given by virtual reality glasses would be Auto-stereoscopic with resolution of 12286 by 7714 pixels with an aspect ratio of 21:9 simulating an environment as large as 40436993706m diagonally.



Figure 4.4.2 Omni Directional Treadmill

### Virtusphere

Virtusphere basically works on the same principles as the Omni-directional treadmill. The only difference is that it uses a freely rotating sphere for movement of the user making it a better simulator for shooter games.

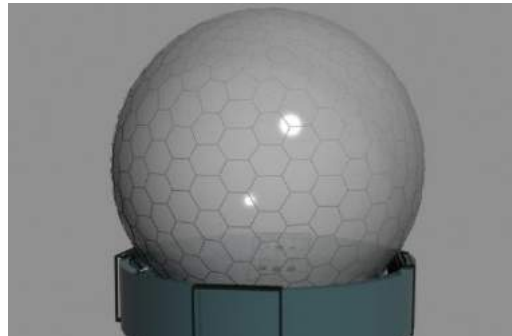

Figure 4.4.3 Virtusphere

### Zero Gravity Football



Figure 4.4.4 Zero Gravity Football

Zero gravity

football a.k.a Galactic football is football played in a zero g environment. It is 15-a-side game played by players equipped with solar electric jetpacks. The football itself would be installed with NDRC molded composite propulsion whose speed would depend upon the force with which it's kicked which would be

measured using impact sensors encrusted on the interior.

### Zero Gravity Basketball

Zero gravity basketball is 7-a-side basketball game played in a zero gravity environment. Player equipment and ball specifications are same as galactic football



Figure 4.4.5 Zero Gravity Basketball

### Galactic Racing

Galactic racing is bike racing in micro gravity on tracks that have metaled roads on the side. High-speed bikes that use Hydroxyl Terminated Poly Butadiene propulsion and super aligned polystyrene polymer coated tires would be operated in Galactic racing.

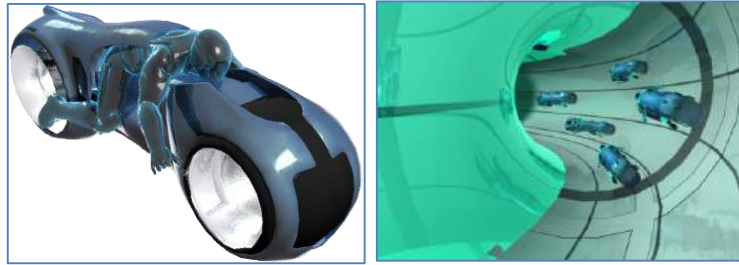

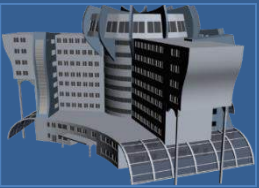



Figure 4.4.6 Galactic Racing

### Recreation in Residential Torus

No man in his sane mind can imagine a life without recreation. Small recreation facilities are present on the Residential Hybrid to torus that don't require much maintenance and provide rejuvenation to residents without exorbitant cost.

RECREATIONAL ACTIVITY	DESCRIPTION
 <p data-bbox="188 1135 341 1167">Public Parks</p>	<p data-bbox="539 913 794 945">Regular public parks.</p>
 <p data-bbox="188 1393 336 1424">Gymnasium</p>	<p data-bbox="539 1182 1302 1214">Gymnasiums with equipment like jogger, treadmills, weights etc.</p>
 <p data-bbox="188 1662 469 1693">Restaurants and hotels</p>	<p data-bbox="539 1442 1374 1532">Restaurants are medium scale luxury or economic dining places for residents. Hotels are temporary luxury, executive, business or economic residential places for residents.</p>
 <p data-bbox="188 1968 411 2000">Amusement parks</p>	<p data-bbox="539 1709 1374 1767">Amusement parks contain various rides, theatres, operas, horror houses and other amusement activities.</p>

**RESEARCH**

Research is one of the main purposes of VONA. The research labs on VONA would not be confined to a particular area but would be distributed all over VONA. The following table shows the areas where research would be carried out and the amount of gravity that would be present in those areas.

**Table 4.5.1 Purpose of Various Gravity Levels in Different Areas**

Area	Gravity Level	Purpose
Residential Area	1g	These labs would be used to conduct various experiments which require an Earth like environment.
Agricultural Area	0.7g	The labs in these areas will mainly concern food production though they would have other researches requiring the amount of gravity produced in this area.
Industrial Area	0.5g	Researches which need half the gravity level of the Earth.
Central Hub	0g	This would be used to conduct various experiments safely in a zero g environment.

**Research Labs in VONA**

Due to these varying gravity levels it would be possible to do researches that are possible in space as well as those researches that can be done on Earth. The various types of research that could be carried out on VONA are listed as follows:-

**Table 4.5.2 Research Fields in VONA**

Name of Lab	Purpose	Position of Lab
Biophysics and Micro-g labs	Observation of the physical effects of prolonged stay of man and other organisms in a micro-g environment and other biophysics	Central Hub, Agricultural and Industrial Areas.
Agricultural and Plant and Biotechnology Labs	The main focus of these labs would be to find various ways and to develop various technologies to increase the quantity as well as the quality of agricultural produce on VONA as well as research on animals for better biomimetic materials and technology	Agricultural Areas
Radiation Labs	This lab would monitor the levels of various types of radiations in space, their effects on humans and other organisms and how to better shield us from these harmful radiations.	All over VONA
Astronomy Labs	In these labs, research concerning heavenly bodies like stars, planets etc. would be conducted	Residential Areas
Metallurgy Labs	These labs would be used to study the various metal samples brought back from Mars, Phobos and Deimos. Researches on producing better alloys would also be conducted in these labs.	Industrial Areas
Pharmaceutical Labs	A number of breakthroughs in the field of medicinal science have occurred due to the technologies developed in space. So, a Pharmaceutical Lab would be present on the settlement to study the human body. The labs would be inaccessible to general public to prevent the risks of	Mainly Residential, Industrial & Agricultural Areas

	disease outbreaks.	
Nanotechnology Lab	A nanotech lab would be present on VONA to research and develop nanotechnology in various fields like medicine, I.T. etc. These would work in collaboration with many other labs for which nanotechnology would be developed. Such labs include pharmaceutical lab, radiation labs etc.	Industrial and Residential Areas
Communications Research Labs	This lab would be placed all over the structure and would focus focusing on developing more efficient ways of communication	All over VONA
Chemical Genetics	In these labs scientists will remove the genetic instructions for entire metabolic pathways from certain microorganisms, alter the instructions, and then put them back hence mutating the test subject.	Industrial and Residential Areas.

### INDUSTRIES

The table below shows the various industries present on VONA and the area allotted for each:-

**Table 4.5.3 Various Industries in VONA**

Name	Location	Area Allotted (in m <sup>2</sup> )
Information Technology	Residential Areas	651
Pharmaceutical	Industrial Areas	8140
Paper & Stationary	Industrial Areas	7450
Furniture	Industrial Areas	20120
F.M.C.G(Fast Moving Consumer Goods)	Industrial Area	31000
Accessories	Industrial Area	7850
Textiles	Industrial Area	8140
Printing	Industrial Area	9520
Consumer Electronics	Industrial Area	10450
Telecom	Residential Area	200

Name	Location	Area Allotted (in m <sup>2</sup> )
Mineral	Industrial Area & Martian Base	89750
Heavy Machinery	Industrial Area, Martian Base	66980
Chemical	Industrial Area	10000
Automation & Transportation	Industrial Area	60600
Food/Agro	Agricultural Areas	48200
Plastic & Rubber	Industrial Area	10090

The remaining area will be used for other activities like processing, testing as well as future expansion.

**NEUTRINO COMMUNICATION**

Neutrino means “small neutral one” in Italian. True to their name, neutrinos are electrically neutral, extremely weakly interacting particles. Neutrinos, being less interacting pass through almost any form of matter, without causing damage or change. In fact, millions of neutrinos pass through us humans every day, indicating no potential harm or danger. Using neutrinos, we can communicate straight from Earth to settlement or any of the Martian or Lunar Bases with just one relay station in between. Here, we compare both free-space Laser optic communication and Neutrino communication.

**Table 4.6.1 Comparison of Neutrino And Laser Communication**

NEUTRINO COMMUNICATION	FREE SPACE OPTICS(LASER)
High-Moderate Data carrying capacity per Neutrino	High Data Carrying Capacity
No deflection at all	Low-moderate deflection
Higher transmission speeds than light due to unsurpassed penetration rates	Relatively low transmission speeds, due to the fact that laser has low penetration and gets interrupted by tiny disturbances
Passes through any medium	Stopped, interrupted, collapsed by a variety of factors on Earth, Mars around and space
Data delivered at higher than 99% efficiency in or less than 2 repetitions	Low data delivery efficiency, multiple repetitions required
Invisible	Visible
Does not interrupt or get interrupted by any process, goes straight to the target or with just one relay	Interrupts process, harmful if collided with the settlement
Maintenance of a complex network not required, just one relay required	Requires maintenance of a fixed, complex and extremely difficult to maintain.
Requires low-medium precision	Extremely high precision required
Does not cause any harm	Skin burns, eye damage, blindness among many others
Can be used for any kind of communication, at any distance	Can only be used for uninterrupted, large distance communication

**Neutrino Beam Production**

For production of neutrinos, the following steps have to be followed:

**PROTON BEAM GENERATION**

Production of a proton beam is necessary in the production of neutrinos because it is these protons from which decay particles called pions (among others), and ultimately neutrinos. Proton beams can be generated through the traditional cyclotron, tandem, or particle accelerator methods. But, we will use a method called, Target Normal Sheath Acceleration (TNSA) for high quality proton beams using Ti: Sapphire LASER. First, an anvil shaped Boron-8 disk around  $100\mu\text{m}$  would be produced. Then a flat Beryllium-7 disk with a radius of  $50\mu\text{m}$  would be perched at its tip. This would be

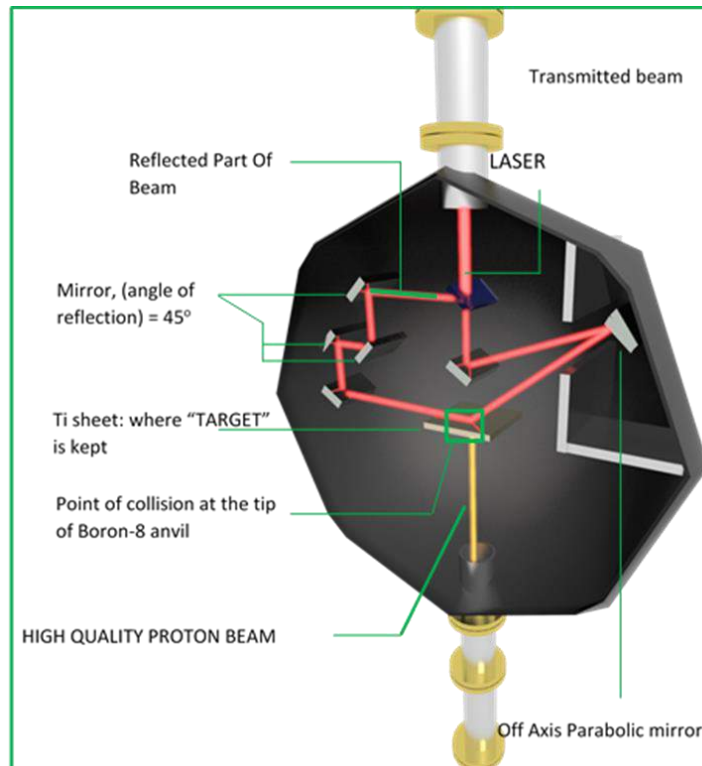

Figure 4.6.1 High Quality Proton Beam Generation

marked as "TARGET" and placed inside proton beam production chamber. A Ti: sapphire LASER which has pulse duration of 1fs and 10TW peak power, operated with 1Hz, would be directed to a beam splitter. A beam splitter allows 50% of the LASER to pass, the rest 50% is reflected at an angle of  $90^\circ$ . The transmitted part of the LASER beam would be directed to an Off-Axis Parabolic Mirror (OAP), with Off-Axis Angle of  $15^\circ$ , which would reflect it towards the TARGET. Meanwhile the reflected part of the beam would be directed towards 6 mirrors (sequentially), each with an angle

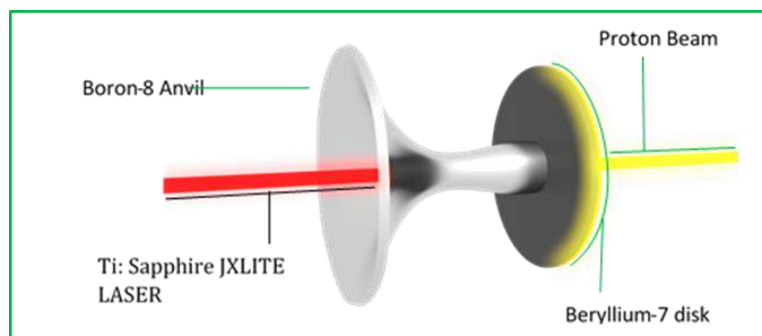

Figure 4.6.2 Target where both lasers collide and Proton Beam is generated

of reflection of  $45^\circ$ , and finally collided with the TARGET, at the exact point where the transmitted beam collided, (**Note : The Point Of Collision Is Set At The Tip Of The Anvil Where The Boron Disk Lies**), leading to liberation of electrons, creating an extremely powerful electric field with an energy of billions of volts. This field would liberate and accelerate the protons away, but in the opposite direction of the LASER beams. This proton beam would then be passed into the particle accelerator, where it would be taken for neutrino production.



## PION GENERATION AND SELECTION

The proton beam would then be accelerated in a particle accelerator and then collided with a target sheet made of Ti, which would lead to the production of massive amounts of sub-atomic particles called pions. Pions of both negative and positive charge would be released due to interaction with both electrons and protons. Shaped Magnetic fields called Focusing Horns would be used to separate the pions on the basis of charge. The pions after production would be passed through a series of focusing horns, the first one would have negatively charged coils to attract positively charged pions. The most important property of focusing horns is that they concentrate particles into collimated beams. The positively charged pion beam would then be passed into yet another accelerator where they would nearly pick up the speed of light. (NOTE: *THE PIONS HAVE A LIFE SPAN OF  $0.026\mu\text{m}$ ; This Would Mean That They Would Be*

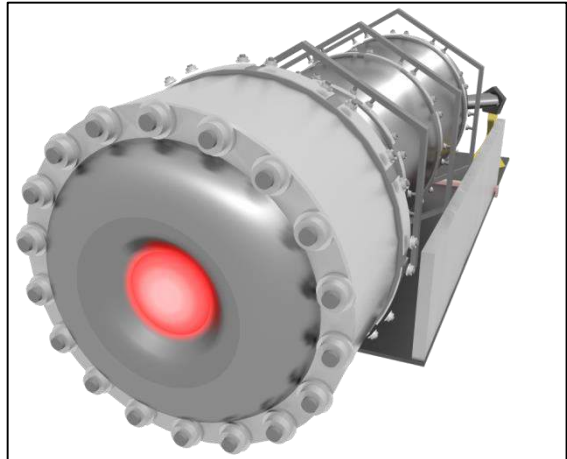

Figure 4.6.3 Magnetic Horn for particle selection

*Destroyed Before Even Passing Halfway Through The Accelerator, No! Since They Are Travelling At The Speed Of Light, They Are Travelling Time, Meaning That Their Internal Time Is Much Slower Than Ours, In The Real World, They Would Last Much Longer. Conclusion: They Would Easily Be Passed Through The Accelerator).*

## PION AND MUON DECAY; NEUTRINO GENERATION

Pion beam would be passed into decay chamber where they would have a long decay volume of 96m. Pions would decay into muons (negatively charged) (and other positively charged particles), which would further decay into neutrinos (each having mass half of muon). According to the law of conservation of Lepton numbers, 2 neutrinos would be produced. But according to the law of conservation of energy, the charge must also be conserved; therefore one of the neutrinos would have negative charge,

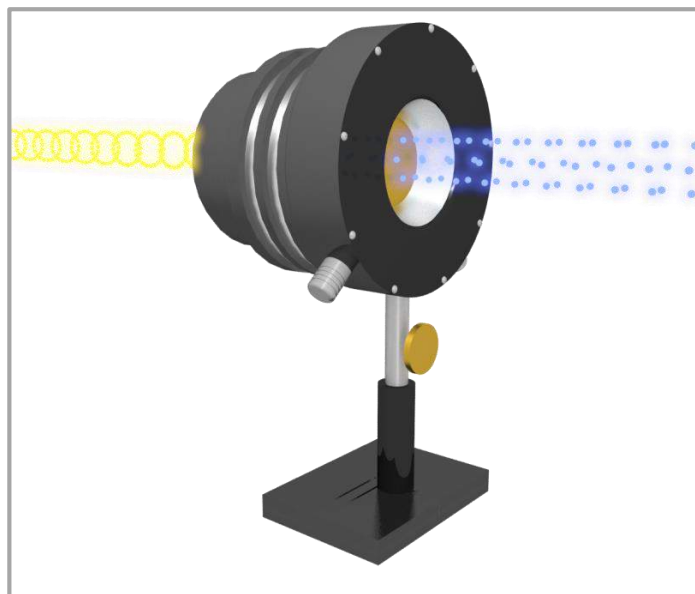

Figure 4.6.4 Proton Beam dump

creating anti-neutrinos which annihilate when they come in contact with neutrinos. All the decay particles would then be passed over a  $400\text{GeV}/c$  positively charged

proton beam dump where all the decay particles except pure neutrinos would be blocked.

## COLLIMATED NEUTRINO BEAM CREATION

Neutrinos would then beam passed into beaming chamber. Neutrinos, as mentioned earlier, have extremely weak interaction. However, if there's one thing neutrinos react slightly less weakly to, then it's GRAVITATIONAL FORCE. Using Gravitational force, we can convert neutrinos into beams. In the beaming chamber, 2 liquid-crystal arsenic based Iron super conductors that show anti-gravity properties on the opposite sides which would direct neutrinos into a beam.

### Transferring Data Using Neutrino Beams (The Gravity Script)

Transferring data using neutrinos can be very difficult. The current binary decoding is an old and primitive system. For transferring data using neutrinos, we would use the gravity script: a script that utilizes gravito-magnetism for creating waves of neutrino particles. The neutrinos, before being transferred to the

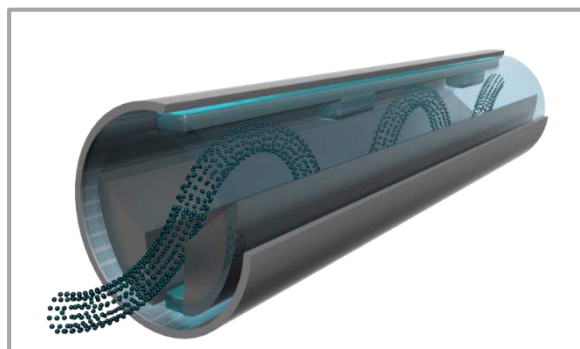

Figure 4.6.5 Gravity Script Generation

settlement would be passed through an encoding tube that would use **liquid Crystal arsenic based iron super conductors** that would create waves of neutrinos just like sound. Each upper wave would be called  $\alpha$  and the lower wave would be called  $\beta$ . Now a series of  $\alpha$  and  $\beta$  would be used just like 0s and 1s in the binary system. Each data in the simplest form would consist of  $\alpha$  and  $\beta$ . This script would replace the usual binary system used in traditional technology.

### Neutrino Deflection

Neutrinos are very weakly interacting particles, but they interacting with gravitational force. For the deflection of neutrinos, we would utilize ultra-pure water dipped graphite powder super conductor which exhibits anti-gravity properties. This anti-gravitational force would deflect neutrinos in the desired direction.

### Neutrino Detection and Monitoring

For neutrino detection, High energy electron field would be used. When

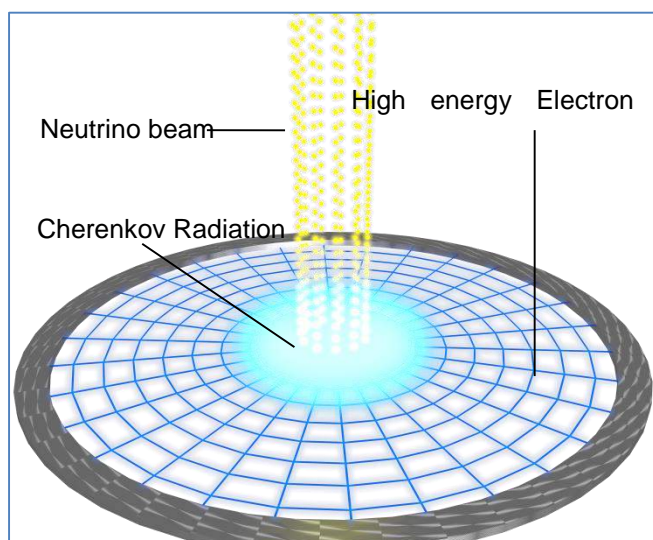

Figure 4.6.6 Collimated Neutrino Beam Collision with high quality electron field for neutrino detection (using Cherenkov Radiation)

neutrinos will collide with this field, high energy Cherenkov radiations along with bright light is produced. This property of neutrinos will be utilized for detection

For monitoring, Lanthanum Bromide ( $\text{LaBr}_3$ ) scintillator with high quality light output and energy resolution of 63 Photons/KeV. Its Hygroscopic properties will be prevented by protecting it using Lotus water Ghost Super Hydrophobic material.

## OPHION SPACE SATELLITE

Ophion satellite consists of 2 parts:

**Main generator unit** Main generator unit consists of a primary neutrino beam producer, 3 secondary neutrino accelerator units.

**Main reception units** Each consists of 6 neutrino concentrators which will maintain the quantity of the neutrino beam, 1 receptor, 1 Accelerator unit which would accelerate Pions and Muons and would convert wasted particles into neutrino beams.

**Solar panel units:** These consist of 9 Hybrid solar panel arrays aligned parallel to each other.

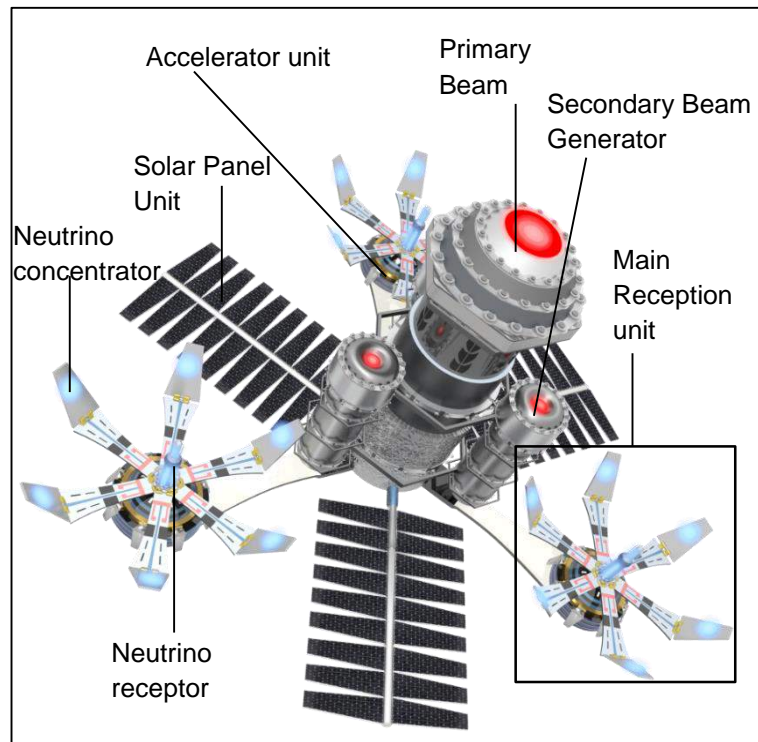

Figure 4.6.6 OPHION

Ophion Communication Network

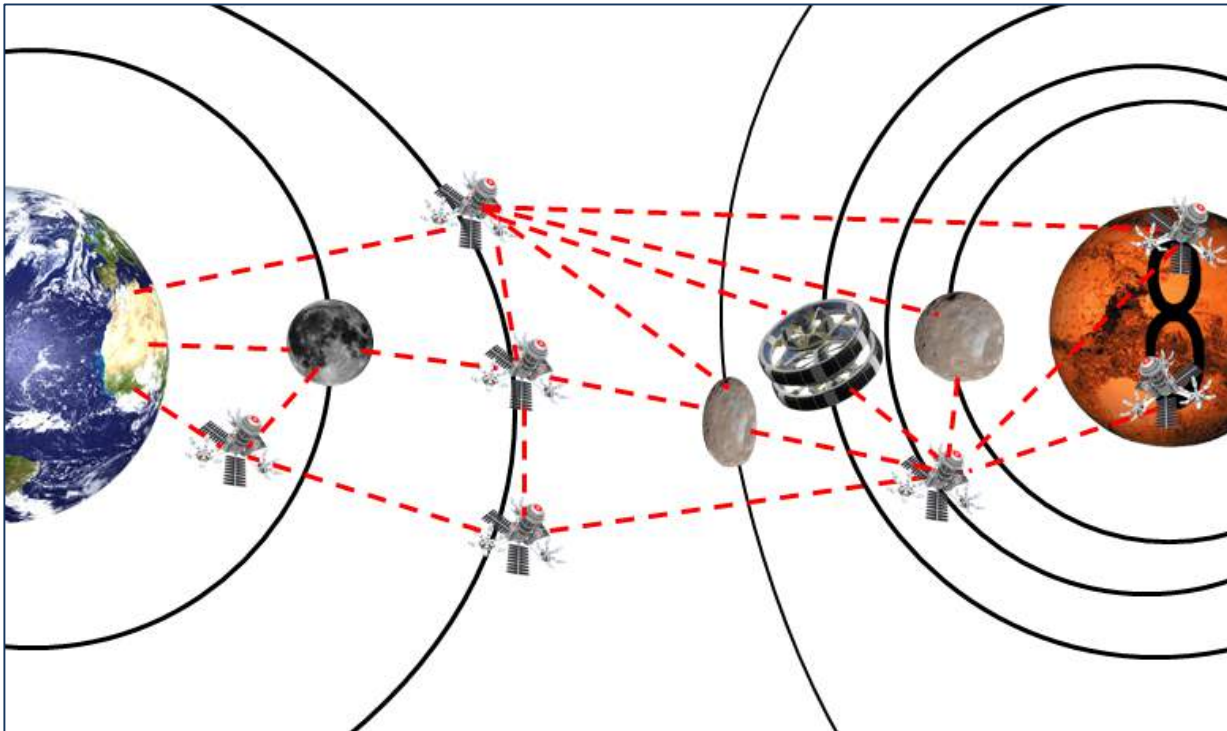

Figure 4.6.7 OPHION Communication Network

Legend	Description	Legend	description
	Connection		VONA space settlement
	Quasi-Zenith orbit around Martian Base and extraction grounds		Phobos
			Moon
	Orbit		Deimos

**INTERNAL COMMUNICATION**

Phone calls and Internet connectivity

For phone calls an LTE (Long Term Evolution) and neutrino based in-ground communication unit. It would consist of 6 neutrino concentrators, 1 neutrino receptor and a LTE 2.0 communication unit. LTE 2.0 has the capability to provide 127

Megabyte/second internet speed and 91 Megabyte/second video call connection speed. Internet connection to Earth would be done using one of the Ophion satellites. Each In-ground communicator would be connected to another In-ground communicator using Laser Optic Fibres.

The ground based communicator would perform 2 important tasks:

1. Internal connectivity using LTE 2.0
2. Earth, Moon and Martian Connectivity using Neutrinos.

For External phone calls to Earth, moon or Mars, LTE 2.0 would first be used to connect to the In-Ground communicator which would later connect to desired location via Ophion satellite.

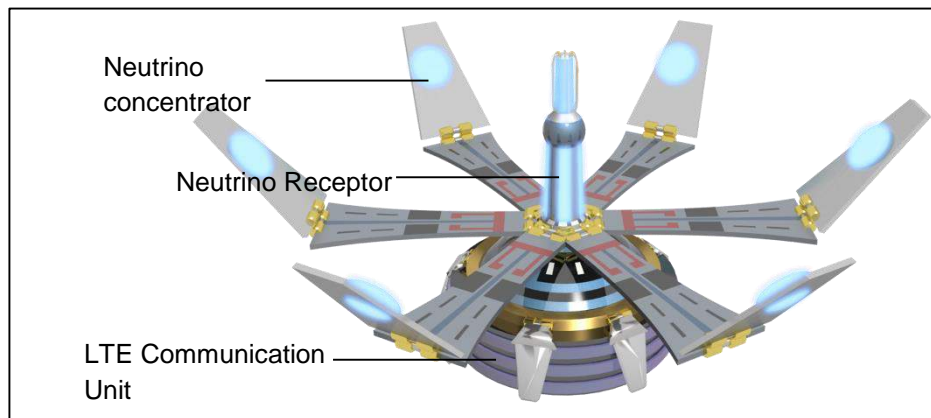

Figure 4.6.8 In-ground Communication unit

### Communication Network

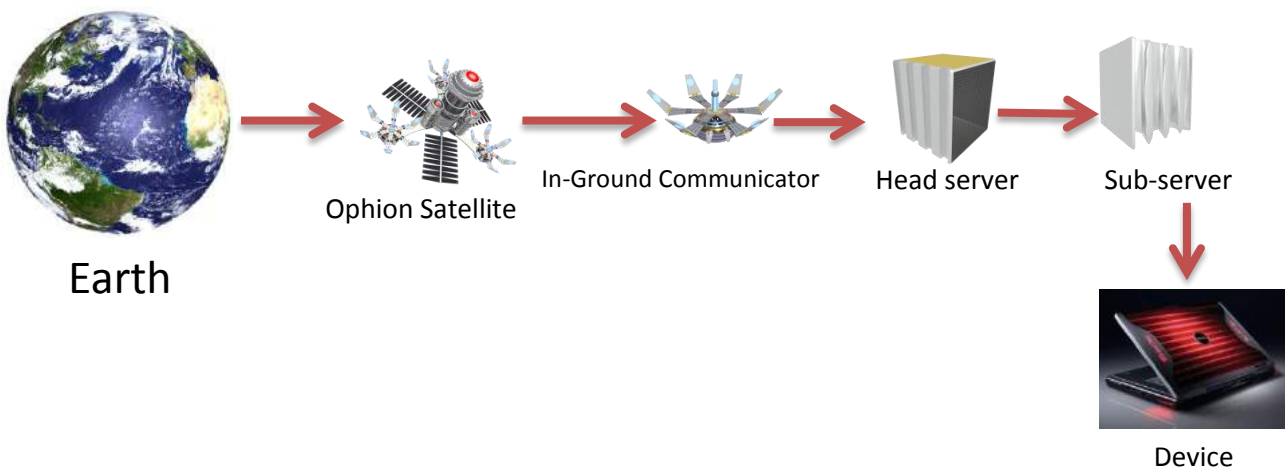

Figure 4.6.9 Internal Communication network

## PROTECTION AND SAFETY

### Password Protection

Protection of passwords can be done using B-crypt hashing which is the finest hashing method due to its flexibility. The number of loops, sequence, or the type of

statements can be changed from time to time. For external communication passwords (banks, satellite access, Earth-VONA video call etc.) 2560 B-Crypt hashing cycles would be used. While for the internal passwords (Research labs access, Industries, Particle accelerator, access to central cylinder etc.), 960 B-Crypt Cycles would be used.

For official communication, servers, and access to data crucial to the working of the settlement and other Essential passwords for VONA, Hexa-decimal, XLOCrypt, JFB Crypt, C-Crypt and  $\pi$  functions would complement the B-Crypt Hashing.

## Phone calls

VT-d, an IOMMU device would create virtual memory inside communication devices for call data. For all internal phone calls, shell encryption would be used along with AES encryption.

## External Communication

External communication would be done using OTP (One Time Pad), an encryption technique that would convert data a secret random key (called Pad) of same length as the default text, resulting in a cypher text. Then each pad would be shuffled with another pad of a different word, followed by sentence shuffling. This would then be followed by Sub-Byte, Shift-Row, Mix column, Hexagesimal data conversion, and byte scrambling. Finally the OTP applied data would go through Quantum Cryptography, making it invulnerable for 50-60 years.



# SECTION.5.0 HUMAN FACTORS

2E210N'2'0 H1W11 E1C10K2

VONA focuses on Mining and Research. For this about 16640 scientists and people will be transported from earth to VONA ranging between just a few months to 65 years.

**DEMOGRAPHICAL FEATURES**

VONA will have a larger unmarried population. The citizens above 50 would be considered as Old. As children are the future bearers of VONA so will be trained physically as well as mentally so that they are highly productive in the future. Schools will be readily available for this job.

Age group	Percentage	Numbers		
		Male	Female	Total Number
00-11yrs	3.75	312	312	624
12-18yrs	7.5	624	624	1248
19-35yrs	50	4160	4160	8320
36 -50yrs	35	2912	2912	5824
51- 65yrs	3.75	312	312	624
Total	100	8320	8320	16640

The age bar of marriage in VONA will be 19 years. This is the age when a person will be capable to make decisions such as Marriage

Age group	Numbers		No of Married		No. of Unmarried		% married		% unmarried	
	Male	Female	Male	Female	Male	Female	Male	Female	Male	Female
19-35yrs	4160	4160	1040	1040	3120	3120	25	25	75	75
36 -50yrs	2912	2912	2184	2184	728	728	75	75	25	25
51-65yrs	312	312	299	299	13	13	96	96	4	4
Total	7384	7384	2524	2524	4860	4860	172	172	128	128

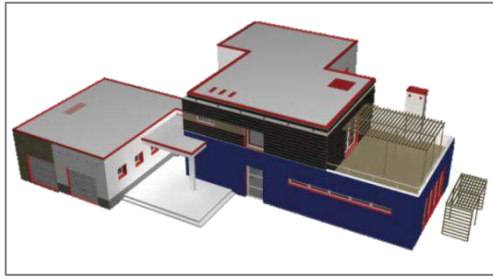

Table 5.3 Division of Citizens in Employment Sector			
Age Group	Gender & Number		Profession
0-11 Children 12-18 Teens (1872)	Youngsters	Teenagers	Children are the Future of VONA. They will be provided with the best education as well as awareness of the resources of VONA.
	Girls-312	Girls -624	
19-35 Active Citizens (8320)	Boys -312	Boys -624	Engineers, Researchers and Scientists, Doctors , Workers
	Male (4160)		
36-50 Semi- Active Citizens (5824)	Female (4160)		Doctors, Engineers , Researchers And Scientists , Market Managers, Businesswomen, Architects
	Male (2912)		Engineers, Researchers and Scientists, Doctors, Counselors, Workers, Businessmen
51-65 Aged Individuals (624)	Female (2912)		Architects, Home Designers , Doctors , Researchers, Counselors , Market Managers , Doctors , Researchers
	Male (312)	Female (312)	They will mainly do the work of counselling, maintaining a good society and a friendly relationship with different communities. They will be the guiders with their bunch of experience to the coming generation and the working population.

VONA would have a number of housing facilities each for a particular economic group. The Houses and apartment complexes will be divided into three categories i.e. the Business class, the Executive class and the Economy class.

### RESIDENTIAL ACCOMMODATIONS

#### Business Class



#### Mansions

These will house the residents belonging to the richer sections of the economy. It would have 3 rooms on each of its 2 floors.

#### Villa

These would have 2 rooms on each of its 3 floors.

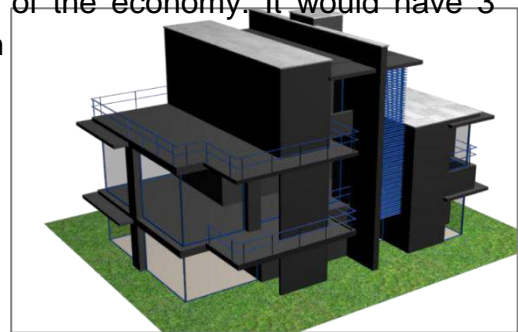

#### Executive Class

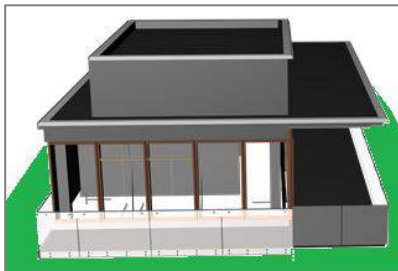

#### Bungalows

These buildings would have 2 rooms on each of its 3 floors.

#### Executive Apartments

These building would have 3 rooms on each of its 3 floors.

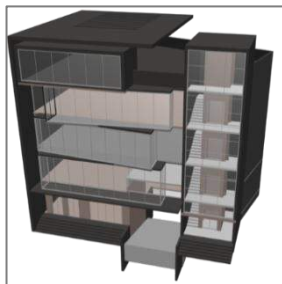
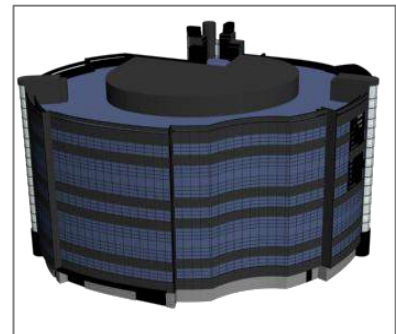

#### Economic Class Apartments

#### High Income Group

These are the buildings which will have 4 rooms on each floor. It will have 5 floors .

#### Moderate Income Group

These are the buildings which will have 6 rooms on each floor. It will have 4 floors .

#### Low Income Group Apartments

These are the buildings which will have 7 rooms on its 5 floors.

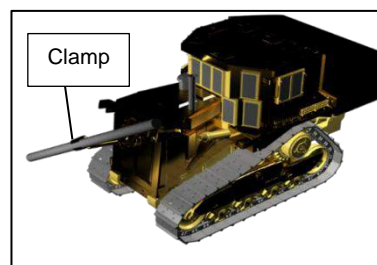

**Table 5.4  
Types and Number of Buildings**

Group	Types Of Buildings	No. of Such Buildings	No. of people accommodated	No. of Floors	Rooms Provided on each floor
Business	• Mansions	17	90	2	3
	• Villa	21	120	3	2
Executive	• Bungalows	10	50	3	2
	• Executive Apartments	18	300	6	3
Economy	• Low Income Group	64	2150	5	7
	• Moderate Income Group	47	1050	4	6
	• High Income Group	22	400	5	4
<b>Total</b>		<b>199</b>	<b>4160</b>		

### House construction

For the construction of Houses, A beam rotating machine with a rotating crocodile clamp capable of free form 360° rotation would be used. Along with the clamp, heating, cooling, and high pressure polymer and adhesive maintenance chambers would also be there.



**Table 5.6  
Population Distribution in Colonies**

Category	Number in Each Colony	Percentage in Each Colony
0-11	156	3.75
12-18	312	7.5
19-35	2080	50
36-50	1456	35
50-65	156	3.75
<b>Total</b>	<b>4160</b>	

**CH. 5.0 HUMAN FACTORS**

**CH. 5.3 EDUCATION**

**EDUCATION**

VONA would have top class teaching facilities. Children will be taught with best-in-class teachers while also maintaining their physical health. By training those in the outer space

environment along with Earth like recreation and environment could nurture a better yield of children leading to a brighter future.

### In Ground education facility

These include automated teaching system as well as the traditional style of schools. While automated teaching will be carried out in the homes of the children using virtual teachers but the education will be concentrated on the conceptual and practical knowledge instead of rote learning. VONA will be equipped with virtual labs, and physical guides aged 50 years or more. Special stress will be paid on Astronomical education along with space exploration and research facilities for students.

### Distance education

VONA would also have long distance education programs connecting the VONA to the best schools, colleges and universities on Earth via neutrino network. This would give the citizens a wide range of jobs to choose from and gaining knowledge of different subjects. The VONA server will be connected with the server of Earth so that the students can download eBooks for the library catalogues of Earth and vice-versa.

*“Government is not reason; it is not eloquent; it is force. Like fire, it is a dangerous servant and a fearful master.”—George Washington*

## GOVERNMENT STRUCTURES

- Constitution

The constitution of our settlement will follow the system of democracy and equality. Every person on VONA shall be granted obligatory privileges, which will protect and serve each person's equality and self-respect. The following shows the obligatory privileges granted to every person.

*Right against Exploitation*

*Right to Liberty*

*Right to property*

*Right to freedom of thought*

*Right to freedom of religion*

*Right to Liberty*

- Preamble

The preamble of VONA provides foundation for its constitution. The preamble of VONA has all the basic requirements and oaths that every citizen on VONA shall follow. The Preamble serves the needs and provides equality to the people.

# PREAMBLE

**We the People of VONA Having Solemnly Resolved to  
Constitute Our Settlement into a SOVEREIGN SECULAR  
REPUBLIC LIBERATED settlement,**

**With determination to build a social and democratic  
settlement based on the rules of law,**

**To build a nation with obligatory privileges available to  
every person,**

**With protection for human dignity**

**For the prosperity of VONA,**

**To never indulge in any criminal activities that may harm  
the beautiful environment of VONA,**

**For PEACE, well-being with a unity of deep sense, harmony  
and cooperation, are among highest values of humanity.**

**We establish this constitution for a better, prosperous and  
worthy country. We the citizens of VONA abide by the  
rules and pledge not to disobey them.**

## Political structure

VONA will have government based on universal adult franchise. Sovereignty will ultimately reside with the people.

## Legislature

Each colony will be divided into 6 constituencies and residents of each constituency will elect one member which will represent the latter. Since, there are 4 colonies a total of 24 members of cabinet of ministers who will make the rules according to the constitution. The members of the cabinet of ministers will have 5 year tenure in the council and each will also be appointed to a post in the president's cabinet. The members of cabinet of ministers which will be a part of the president's cabinet will be controlling different fields of VONA. Agendas for eligibility for contesting Cabinet of Minister's Elections:

- Cabinet of ministers who are PhD holder could stand in election but if a person who has potential and provided all his/her resources be utilized for welfare of VONA.
- Any person with any kind of criminal records will not be eligible for standing for any government post whether male or female.
- Only the residents above the age of 24 can contest the elections

The rules and amendments that are made by the cabinet of ministers for the constitution will be sent to the president for approval. The president will be the head of VONA who will keep a check on all the processes which are taking place in VONA. The president will be elected by the people and will serve tenure of 5 years.

Agendas for eligibility for Presidential Elections:

- Only residents holding PhD Degree can avail contest for elections as such a high post requires a person to be highly educated.
- The minimum age on the person would be 30 years with a minimum political experience of 3 years
- No one holding any criminal record can contest elections for Post of the President. Neither shall he/she be hiding their criminal records if any.

**Table 5.5**

Department	No. of Members appointed
Agricultural torus	2
air management systems	1
communication department	1
Docking Ports	2
Industrial Waves Structure	4
Martian and lunar bases	2
Recreation Hub	1
Residential Hybrid Tori	6
transportation department	3
waste management systems	1
Water management systems	1

## Executive

Executive will consist of police forces and high post officials who will execute the laws made by the Cabinet of Ministers and will maintain peace and security inside VONA. Any person who is convicted of any type of crime will be caught by the police officers, tried in court and if found guilty, he/she shall be prosecuted.

Figure 1: Political Structure

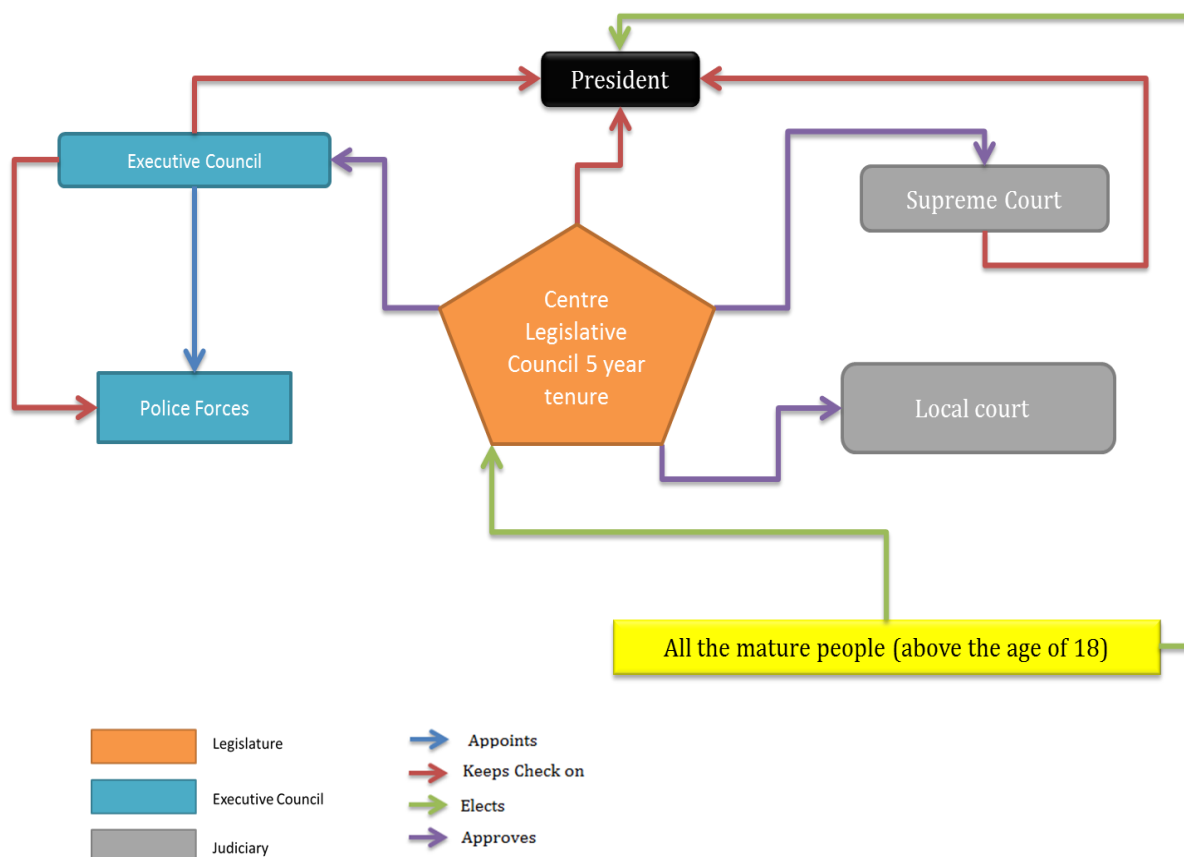

There will be 1 head of the executive council and 4 other members of the council. The head of the executive council will keep check on the other members of the council. All the members of the Executive Council will serve tenure of 4 years. Posts of the members of the executive council:-

- **Chief Executive:** Will check the working of the executive council as well as the ruling party which forms the government.
- **Chief Security Head:** Will ensure the security of the residents of VONA.
- **Head of Financial policies:** Will protect the value of the currency of VONA and will also monitor and maintain the security around the banks in VONA
- **Administrator of Police Forces:** Will keep a check on the working of the police forces and will also ensure that the people recruited in these forces are paid their salaries when it is due.

- **Prosecution Head:** Will ensure the proper working of the jailing system and when a person is convicted of any type of crime, he will be presented before the court only when the Prosecution Head approves his plea.

Members of the Executive Council will be elected by the people. The requirements for contesting the elections for the executive council are:

- The residents contesting for the post of the Chief Executive must be holding a PhD degree because this is a very important post in VONA and only a learned and educated person can do justice with this post.
- The residents contesting for posts other than that of the chief executive in the Executive Council must be at least a Post Graduate.
- The residents contesting the elections of any post in the Executive Council must have no criminal records.
- The minimum age of contesting the elections for the Executive Council is 28 years.

People in the police forces shall be appointed only when they have received training of 2.5 years. The total people recruited in the police forces shall be 8 per year.

## Judiciary

The judiciary in VONA will be termed as HJC (VONA Judiciary Council). There will be a single court in VONA which will not be influenced by any other part of the government i.e. the judiciary in VONA will be independent and more powerful than legislative and the executive council. The judiciary will decide whether a convicted person is guilty or not. The judiciary will consist of 7 judges who will be given the positions on the basis of their ranks in the HJC examination. The minimum age of giving this examination is 35 years and these judges will retire at the age of 42. The judges will serve tenure of 4 years in the court. When a person will clear this exam and will have a high rank, he/she will be appointed as a judge in the court but when their tenure ends after 4 years; the person shall be once again allowed to give the examination till he/she reaches the age of 42 years. If an ex-judge again decides to give the examination and also he/she clears the exam and comes in the merit, then they cannot serve as a judge for 4 years, he/she shall retire at the age of 42 and then retire in the middle of their tenure. The judiciary of VONA shall resolve the following conflicts and shall provide justice to the people:

- Conflicts and disputes between the citizens of VONA.
- Conflicts between citizens and the government.
- Conflicts between different organs of the government.





**SECTION 6.0 FINANCE &  
SCHEDULE**

**SCHEDULE  
SECTION 6.0 FINANCE &**

Business in VONA will be done to recover the money which will be spent on the venture. The major investments which will be done for VONA's venture will be the issuing of different licenses, construction of the structure, Lunar and Martian base and capturing Amun 3554.

### **FUNDING VONA VENTURE**

For the funding of VONA's venture, a funding society will be created to collect the money from different countries and private companies which will be willing to invest their money in this venture.

### **ISSUING LICENSES**

Licenses will be issued for constructing the structure of VONA in space, building of the Martian and Lunar bases, to capture Amun 3554 and using Areosynchronous Orbit as the primary location for VONA.

### **RECOVERING THE MONEY BACK**

**Selling and using Resources extracted from Amun 3554, Moon and Mars**  
Money will be recovered mainly after selling the resources and minerals collected from the Asteroid 3554 Amun and the Martian and Lunar bases. Some of these minerals will also be taken to the industrial sector in VONA for making finished products for both the use of the citizens of VONA and exporting them to Earth.

**Contracts** The people who wish to come and settle in VONA will be provided with different contracts and according to the contract signed by the people, houses and flats will be given to them.

**Selling of concepts** New and futuristic concepts which will be used in VONA and the Martian and Lunar bases like Neutrino Communication, materials used in construction, hybrid solar cells, hybrid wind turbines and the design of the hybrid residential torus will also be sold to different companies.

**Industries in VONA** Industrial Waves structure will be divided into different sectors which will be allotted to different private companies on the basis of the contracts that they sign and the money that they are willing to pay.

**Internal and external transportation** Different companies will be given contracts for carrying out the internal and external transportation. These companies can buy the raw materials from the Martian and Lunar bases so that they can make the vehicles and space crafts for transportation. These companies will also transport the materials from the Martian and Lunar bases to the Industrial Waves structure and will also carry the finished products back to Earth.

**Sale of extracted minerals** Selling of minerals extracted from Moon will start in 2050. These minerals will be sold in auctions which will take place in VONA every year. The major minerals which will be extracted from Moon are aluminium, iron, silicon, magnesium, xenon, krypton, anorthite, silicates, olivine, titanium dioxide, silicon dioxide, chromium oxide, helium 3 and deuterium. All these minerals will be sold completely over the span of 10 years and are expected to fetch \$150 billion.

Selling of the minerals extracted from Amun 3554 will start in 2063 and all the minerals will also be put up for auction. Minerals which will be extracted from Amun

3554 are platinum, iron, nickel, cobalt and palladium. The total profit that we can get after selling all the minerals extracted from Amun 3554 will be \$400 billion.

Selling of minerals extracted from Mars will start in 2066. These minerals will be sold over a span of 20 years and will be sold in auction. The minerals extracted are potassium, silicon, iron, caesium, sulphur, magnesium, aluminium, titanium, platinum, basalt, chromium, lithium, cobalt, zinc, copper, nickel, tungsten and gold and will fetch a price of \$250 billion.

## SECTION 6.0 FINANCE & SCHEDULE

## CH. 6.2 COST

<i>Operations And Infrastructure</i>	<i>Units</i>	<i>Cost [\$]</i>
Radiation Protection Units	94	\$ 4,49,105
Harmony	20	\$ 98,24,228
Electric Cars	20	\$ 21,65,225
Mono Rails	4	\$ 98,24,778
Moving Sidewalks	52	\$ 1,99,112
Transport Elevators	33	\$ 12,32,445
Research Labs	4	\$ 12,25,226
Industries	2	\$ 92,10,00,112
Luxim Plasma Bulbs	7	\$ 28,00,449
Stacked Organic LEDs	7	\$ 12,28,000
Transparent Organic LEDs	7	\$ 11,10,003
Polycarbon Lexan Sheets	5	\$ 10,47,220
Metal Halide Lamps	4	\$ 7,88,000
Halogen Metal Iodide	2	\$ 9,91,000
Spd Smart Glass	5	\$ 49,48,000
<b>Total Cost*</b>	<b>266</b>	<b>\$ 2,290,308,943</b>
<i>Internal Infrastructure</i>		
Residential Flooring	2	\$11,003,554,485
Agricultural Flooring	1	\$12,225,289,445
Industrial Flooring	2	\$12,003,779,000
Docks Flooring	2	\$265,445,000
Hydroponic Units	2.5	\$ 158,000
Aeroponic Units	2.5	\$ 138,000
Zeoponics	4	\$ 1,150,114
Animal Husbandry	9	\$ 445,256
Mansions	17	\$ 2,045,000
Villas	21	\$ 2,115,665
Bungalows	10	\$ 2,520,000
Executive Apartments	18	\$ 3,557,000
Low Income Group	64	\$ 1,058,456
Moderate Income Group	67	\$ 2,974,264
High Income Group	22	\$ 3,549,336
House Construction Machine	25	\$ 598,028
Life Support Chambers	20	\$ 201,556
Fire Stations	20	\$ 45,035
Clinics And Other Specialities	52	\$ 42,016
Markets	56	\$ 159,356
Community Halls	12	\$ 1,696,548
Holy Places	48	\$ 24,225
Residential Colonies*	164	\$ 336,564
Banks	16	\$ 448,563
Schools And Colleges	4	\$ 864,168
Graveyard	4	\$ 23,579
Multispecialty Hospitals	4	\$ 985,219
Offices	4	\$ 469,778
Water Storage	4	\$ 779,256
Storage	8	\$ 261,654
<b>Total</b>	<b>685</b>	<b>\$ 59,423,183,804</b>

<i>Structural Components</i>		
Hybrid Torus A	1	1,738,833,760
Hybrid Torus B	1	1,738,833,760
Piraso	1	1,200,145,760
Spoke Type A	2	69,556,123
Spoke Type B	1	50,140,000
Spoke Type C	2	115,000,148
Wave Connectors	2	84,256,669
Central Hub	1	1,259,966,147
Recreation Sphere	2	1,145,256,985
Docking Port [Exterior]	2	2,458,200,000
Docking Stations	16	812,532
Collider	1	384,256,241
Illumination Mylar	2	30,146,954
Illumination Prisms	7	41,256,778
Neutrino Communicator	2	61,000,256
Resonant Chambers	12	74,156
Industrial Waves	2	3,236,897,125
Biomemetic Tiling	10	92,287,810,000
<b>Total</b>	<b>67</b>	<b>206,539,335,626</b>

<i>Recreation Facilities Per Sphere And Torus</i>		
Omnidirectional Treadmill	10	1,879,000
Virusphere	15	1,241,000
0 G Football Stadium	1	44,226,000
0 G Basketball Courts	2	1,104,000
Wall Racing Track	1	24,296,000
Parks And Ponds	8	10,485,000
Gymnasiums	15	1,558,000
Malls	2	9,224,000
Gaming Parlours	2	1,332,000
Casino	2	1,778,000
<b>Total</b>	<b>58</b>	<b>240,053,000</b>
<i>Total Cost For All The Tori And Sphere</i>	<b>116</b>	<b>480,106,000</b>

<i>Total Facilities</i>	<i>Cost</i>
Structural Components	\$ 206,539,335,626
Recreation Facilities	\$ 480,106,000
Operations And Infrastructure	\$ 2,290,308,943
Internal Infrastructure	\$ 59,423,183,804
Life Support Facilities Per Torus	\$ 208,070,947,182
Martian Base And Lunar Base	\$ 8,561,158,219
<b>Total Cost</b>	<b>\$ 485,365,039,774</b>

**TOTAL COST OF VONA:  
\$485,365,039,774**

SECTION 6.0 FINANCE & SCHEDULE

CH.6.3 SCHEDULE

It will take 30 years for VONA to start. Given below is the schedule.

Task	2020	2021	2022	2023	2024	2025	2026	2027	2028	2029	2030	2031	2032	2033	2034	2035	2036	2037	2038	2039	2040	2041	2042	2043	2044	2045	2046	2047	2048	2049	2050		
Construction Team Recruitment																																	
Construction Team Finalized																																	
Construction studies																																	
Meeting with Space authorities																																	
Getting approval from countries																																	
Approval from Space Authorities																																	
Raising Funds																																	
Lunar Base Construction																																	
Thrusters																																	
Robots And Vehicles																																	
Import of materials for construction																																	
Docks and central hub																																	
Agricultural Torus and interior																																	
Industrial Waves and interior																																	
Capturing of 3554 Amun																																	
Sending Amun to Lunar Base																																	
Transfer Orbit																																	
Reaching Areosynchronous																																	
Completion of the settlement																																	
Martian Base																																	
Full Extraction of the Asteroid																																	
Interior Designing																																	
Solar Panel Placing																																	
Life Support systems																																	
Starting of the Rotation																																	
Testing of The settlement																																	
Final finishes																																	
Transport of people																																	
Settling in																																	

**LEGEND:**

- Research
- Construction
- Fit for Usage
- Transport
- Asteroid Tasks
- Testing
- Settling in

# CONCLUSION

If you assemble your dreams like a mosaic pattern of a jigsaw puzzle, you see your future realized only when the puzzle is complete. The lessons we learnt in making little mistakes while completing the project made all the difference. We may not remember specifically, but many factors have made the larger picture brighter.... Was it a subtle gesture? A sensitive knowing nod? A well-timed pat on the back by our worthy teachers?

The journey of this project has been an amazing, dynamic endeavour. The sense of accomplishment we experience outweighs the toil and hard-work consumed.

Creating something from nothing is incredibly inspiring; not only for the creator, but for everyone who observes. Everything begins with "Inspiration " and the attitude that "Impossible is Nothing". It may be cliché to say "Don't sweat the small stuff", but according to us "if you sweat the small stuff, make sure it counts". Law of motion states "Objects in motion stay in motion", therefore a mind once stretched by intellect and reasoning will keep on thinking out of the box.

"VONA, the brainchild of Apeejay Space team, has provided us an opportunity to widen the horizons of our thought process and virtually design the world **THE WAY WE WANT IT TO BE.....**

## BIBLIOGRAPHY

### Water Management:

- [http://www.observatorynano.eu/project/filesystem/files/nZVI\\_final\\_vsObservatory.pdf](http://www.observatorynano.eu/project/filesystem/files/nZVI_final_vsObservatory.pdf)
- <http://www.liqui-cel.com/uploads/documents/TB74-Ammonia-Removal-10-09.pdf>
- <http://espwaterproducts.com/about-reverse-osmosis.htm>
- [http://www.nasa.gov/mission\\_pages/MRO/news/mro20110804.html](http://www.nasa.gov/mission_pages/MRO/news/mro20110804.html)
- <http://www.waterprofessionals.com/ultrapure/electrodeionization.html>
- [http://www.sintef.no/project/IK23430000%20SACS/other\\_reports/BGS\\_WA3\\_CO2\\_%20solubility\\_expts.pdf](http://www.sintef.no/project/IK23430000%20SACS/other_reports/BGS_WA3_CO2_%20solubility_expts.pdf)
- <http://www.tandfonline.com/doi/abs/10.1080/02508069.608686494#preview>
- <http://www.enviroalternatives.com/watermethods.html>
- <http://www.popsci.com/technology/article/2009-10/interview-nasa-scientists-plan-extract-moon-water-affordably-using-common-household-appliance>
- [http://science.nasa.gov/science-news/science-at-nasa/2009/07oct\\_microwave/](http://science.nasa.gov/science-news/science-at-nasa/2009/07oct_microwave/)
- <http://www.space.com/7350-nasa-hopes-water-moon.html>
- <http://www.axeonwater.com/Ion-Exchange.html>
- [http://www.nasa.gov/centers/johnson/pdf/579087mainMSC-24180-1\\_Water-Filtering-Device.pdf](http://www.nasa.gov/centers/johnson/pdf/579087mainMSC-24180-1_Water-Filtering-Device.pdf)
- <http://www.popsci.com/technology/article/2012-07/things-you-can-make-graphene-drug-detectors-transistors-and-tasty-drinkable-seawater>

### Illumination

- <http://www.edisontechcenter.org/metalhalide.html>
- <http://science.howstuffworks.com/solarsail1.htm>
- [http://usa.dupontteijinfilms.com/informationcenter/downloads/Chemical\\_Properties.pdf](http://usa.dupontteijinfilms.com/informationcenter/downloads/Chemical_Properties.pdf)
- <http://www.smartglassinternational.com/products-services/spd-smartglass-solar-control/>
- <http://lexanpolycarbonate.com/>
- <http://www.luxim.com/>

### Location

- [http://www.google.co.in/url?sa=t&rct=j&q=&esrc=s&frm=1&source=web&cd=1&ved=0CDQQFjAA&url=http%3A%2F%2Farc.aiaa.org%2Fdoi%2Fpdf%2F10.2514%2F6.2008-6429&ei=1uIUZK-EoTorQeCwYC4BQ&usq=AFQjCNHJBCRVZpxlXWadRtObd3W7tOJnWg&sig2=xcQcsTORNdPs\\_xKQEnq4XA](http://www.google.co.in/url?sa=t&rct=j&q=&esrc=s&frm=1&source=web&cd=1&ved=0CDQQFjAA&url=http%3A%2F%2Farc.aiaa.org%2Fdoi%2Fpdf%2F10.2514%2F6.2008-6429&ei=1uIUZK-EoTorQeCwYC4BQ&usq=AFQjCNHJBCRVZpxlXWadRtObd3W7tOJnWg&sig2=xcQcsTORNdPs_xKQEnq4XA)
- [http://www.polaris.iastate.edu/EveningStar/Unit6/unit6\\_sub2.htm](http://www.polaris.iastate.edu/EveningStar/Unit6/unit6_sub2.htm)
- [http://www.windows2universe.org/mars/mars\\_orbit.html](http://www.windows2universe.org/mars/mars_orbit.html)
- <http://www.orbitsimulator.com/gravity/articles/what.html>
- [http://www.orbitsimulator.com/gravity/simulations/areo\\_synchronous\\_gsims](http://www.orbitsimulator.com/gravity/simulations/areo_synchronous_gsims)
- <http://nineplanets.org/asteroids.html>
- <http://astronomy.activeboard.com/t40045801/asteroid-3554-amun/>
- <http://www.permanent.com/near-earth-asteroids.html>
- <http://ssd.jpl.nasa.gov/sbdb.cgi?sstr=3554;orb=0;cov=0;log=0;cad=1#orb>

### Radiation Protection

- <http://hps.org/publicinformation/ate/faqs/radiationdetection.html>
- [http://www.google.com/url?sa=t&rct=j&q=&esrc=s&frm=1&source=web&cd=1&ved=0CDYQFjAA&url=http%3A%2F%2Fntns.nasa.gov%2Farchive%2Fnasa%2Fcasi.ntns.nasa.gov%2F20030032274\\_2003026279.pdf&ei=bvsJUbggFMeGAFr4oDwBg&usq=AFQjCNFZNDpn7gwRcoKpTKODJny3sDdAHg&sig2=2jxRX-X1HOprTtPGmgBcGw&bvm=bv.41642243,d.bmk](http://www.google.com/url?sa=t&rct=j&q=&esrc=s&frm=1&source=web&cd=1&ved=0CDYQFjAA&url=http%3A%2F%2Fntns.nasa.gov%2Farchive%2Fnasa%2Fcasi.ntns.nasa.gov%2F20030032274_2003026279.pdf&ei=bvsJUbggFMeGAFr4oDwBg&usq=AFQjCNFZNDpn7gwRcoKpTKODJny3sDdAHg&sig2=2jxRX-X1HOprTtPGmgBcGw&bvm=bv.41642243,d.bmk)

- <http://web.eps.utk.edu/faculty/taylor/pubs/Miller-radiation%20measurement.pdf>
- <http://www.popsci.com/technology/article/2011-01/new-metallic-glass-toughest-strongest-material-yet>
- [http://science.nasa.gov/science-news/science-at-nasa/2005/25aug\\_plasticspaceships/](http://science.nasa.gov/science-news/science-at-nasa/2005/25aug_plasticspaceships/)

### Electricity

- <http://www.materials360online.com/newsDetails/12540>
- <http://www.popsci.com/technology/article/2012-11/fyi-what-darkest-material-earth>
- <http://newsroom.ucla.edu/portal/ucla-researchers-create-highly-236698.aspx>
- <http://www.teijin.co.jp/english/news/2012/ebd120906.pdf>
- <http://www.gizmag.com/most-efficient-thermoelectric-material/24210/>
- <http://large.stanford.edu/courses/2012/ph240/wang-hu1/>
- <http://www.gizmag.com/light-thermal-electricity-hybrid-nanomaterial/24989/>
- [http://mydocs.epri.com/docs/publicmeetingmaterials/1110/7TNRSL46577/12%20-%20Superconducting%20Magnetic%20Energy%20Storage%20system%20for%20GRIDS%20\(Lehner%20for%20Li\).pdf](http://mydocs.epri.com/docs/publicmeetingmaterials/1110/7TNRSL46577/12%20-%20Superconducting%20Magnetic%20Energy%20Storage%20system%20for%20GRIDS%20(Lehner%20for%20Li).pdf)
- [http://www.bvucoepune.edu.in/pdfs/Research%20and%20Publication/Research%20Publications\\_2010-11/National\\_Conference\\_2010-11/Super%20conducting%20magnetic.pdf](http://www.bvucoepune.edu.in/pdfs/Research%20and%20Publication/Research%20Publications_2010-11/National_Conference_2010-11/Super%20conducting%20magnetic.pdf)
- <http://www.technologyreview.com/view/509081/best-of-2012-room-temperature-superconductivity-found-in-graphite-grains/>
- <http://ibmresearchnews.blogspot.in/2012/10/superconducting-at-room-temperature.html>
- <http://www.cornellcollege.edu/physics/files/mandip-sibakoti.pdf>

### Lunar Base

- <http://www.space.com/16222-moon-water-ice-shackleton-crater.html>
- <http://nextbigfuture.com/2012/06/extensive-water-in-interior-of-mars-and.html>
- <http://www.asi.org/adb/04/03/10/04/oxygen-extraction.html>
- [http://isru.msfc.nasa.gov/lib/Documents/PDF%20Files/Significant\\_Lunar\\_Minerals.pdf](http://isru.msfc.nasa.gov/lib/Documents/PDF%20Files/Significant_Lunar_Minerals.pdf)
- <http://www.permanent.com/lunar-geology-minerals.html>

### Materials Required:

- <http://www.pbs.org/wgbh/nova/nature/nature-materials.html>
- <http://www.matweb.com/search/datasheet.aspx?matguid=638937fc52ca4683bc0c3f18f54f5a24&ckck=1>
- <http://www.matweb.com/search/datasheet.aspx?matguid=1a5f4985c8fb449da6edaec7813acf70&ckck=1>
- <http://www.sciencemag.org/content/321/5887/385.abstr.act>
- <http://www.torayca.com/pdfs/T1000GDataSheet.pdf>
- [http://www.fols.org/fols\\_library/white\\_papers/document/s/Fiber%20Myths%20White%20Paper%20final.pdf](http://www.fols.org/fols_library/white_papers/document/s/Fiber%20Myths%20White%20Paper%20final.pdf)
- <http://www.wisegeek.com/which-material-has-the-highest-melting-point.htm>
- <http://www.memsnets.org/material/titaniumcarbide/ticbulk/>
- <http://www.popsci.com/science/article/2010-12/new-carbon-nanotube-flubber-could-be-used-sneakers-and-spacecraft>
- <http://blogs.discovermagazine.com/80beats/2010/12/03/super-rubber-made-of-nanotubes-stretches-like-elastic-oozes-like-honey/>
- <http://www.google.com/url?sa=t&rct=j&q=&esrc=s&frm=1&source=web&cd=1&ved=0CDMQFjAA&url=http%3A%2>

F%2Fwww.popsci.com%2Ftechnology%2Farticle%2F2011-05%2Fnew-diamond-aerogel-least-dense-diamond-ever-made&ei=B3cPUZOIG8vtrQfHjIGADw&usq=AFQjCNFSCwR X37rrEdLzqVHLM22PE24HA&sig2=Y9pSzz Xz05HfyVSL\_N xsA&bvm=bv.41867550.d.bmk

- <http://nextbigfuture.com/2012/08/flexible-aerogels-that-are-500-times.html>
- <http://www.atimetals.com/products/Pages/tungsten-group-niobium.aspx>
- <http://abcnews.go.com/blogs/technology/2012/11/nano-material-can-stop-a-speeding-bullet-strenghten-soldiers-body-armor/>
- <http://www.permapure.com/tech-notes/key-concepts/nafion-physical-and-chemical-properties/>
- <http://www.nanowerk.com/news/newsid=18063.php>
- <http://www.memstnet.org/material/siliconcarbidesicbulk/>
- <http://www.matweb.com/reference/titanium.aspx>
- <http://phys.org/news/2012-03-theorize-cold-compression-graphite-results.html>
- [http://en.wikipedia.org/wiki/Carbon\\_allotropes](http://en.wikipedia.org/wiki/Carbon_allotropes)
- <http://www.spacex.com/press.php?page=20090223>
- <http://www.gizmag.com/transparent-soil/24383/>
- <http://www.matweb.com/search/DataSheet.aspx?MatGUID=b141bfe746f142638fdc30ac59aa306e&ckck=1>
- [http://www.chemicalbook.com/ChemicalProductProperty\\_EN\\_CB1511512.htm](http://www.chemicalbook.com/ChemicalProductProperty_EN_CB1511512.htm)

#### Waste Management

- <http://www.ecoecosse.com/technology.php>
- [http://mitec.en.alibaba.com/product/549899404-212553533/2012\\_New\\_Solid\\_and\\_liquid\\_organic\\_fertilizer\\_extraction\\_machine\\_for\\_animal\\_waste.html](http://mitec.en.alibaba.com/product/549899404-212553533/2012_New_Solid_and_liquid_organic_fertilizer_extraction_machine_for_animal_waste.html)
- <http://www.bokashidirect.co.uk/bokashi-buckets.htm>
- <http://www.bvmengineering.ac.in/docs/published%20papers/civilstruct/Civil/101017.pdf>
- [http://www.plastemart.com/PrintFile.asp?REF=/webtech/upload/Literature/Plastic\\_Weaving\\_Unit\\_Profile.asp&http://1016079.en.makepolo.com/products/City-Waste-Recycling-Separating-Machine-p22162258.html](http://www.plastemart.com/PrintFile.asp?REF=/webtech/upload/Literature/Plastic_Weaving_Unit_Profile.asp&http://1016079.en.makepolo.com/products/City-Waste-Recycling-Separating-Machine-p22162258.html)
- [http://www.alibaba.com/product-gs/561694430/China\\_Famous\\_Glass\\_Recycling\\_Machine\\_Ruiguang.html](http://www.alibaba.com/product-gs/561694430/China_Famous_Glass_Recycling_Machine_Ruiguang.html)
- [http://hardenindustries.en.alibaba.com/product/396869403-213255405/Glass\\_recycling\\_machine.html](http://hardenindustries.en.alibaba.com/product/396869403-213255405/Glass_recycling_machine.html)
- <http://jygaode.en.made-in-china.com/product/jolnrvidwycs/China-Hydraulic-Metal-Baler-HC81-Q-1350-.html>
- <http://www.seekpart.com/company/120807/products/201212594697502713893265.html>
- [http://jyftmy.en.alibaba.com/product/653378919-210333051/Y81\\_1350\\_hydraulic\\_scrap\\_aluminum\\_recycling\\_machinery.html](http://jyftmy.en.alibaba.com/product/653378919-210333051/Y81_1350_hydraulic_scrap_aluminum_recycling_machinery.html)
- [http://www.holisticdecisions.com/LA\\_FREE\\_waste\\_recycling.pdf](http://www.holisticdecisions.com/LA_FREE_waste_recycling.pdf)
- [http://hndt.en.alibaba.com/product/519425298-212962760/lead\\_and\\_continuous\\_waste\\_plastics\\_recycling\\_machine.html](http://hndt.en.alibaba.com/product/519425298-212962760/lead_and_continuous_waste_plastics_recycling_machine.html)
- [http://www.nyc.gov/html/dsnv/downloads/pdf/swmp\\_implementation/otherinit/wmtech/phase1.pdf](http://www.nyc.gov/html/dsnv/downloads/pdf/swmp_implementation/otherinit/wmtech/phase1.pdf)
- <http://inhabitat.com/brilliant-device-turns-waste-paper-into-pencils/>
- [http://hnaimeisi.en.alibaba.com/product/449018122-210269340/scrap\\_pcb\\_recycling\\_machine.html](http://hnaimeisi.en.alibaba.com/product/449018122-210269340/scrap_pcb_recycling_machine.html)
- [http://www.cpcb.nic.in/wast/plasticwast/Plastic\\_waste-1.pdf](http://www.cpcb.nic.in/wast/plasticwast/Plastic_waste-1.pdf)
- <http://taramachines.com/TAR-PaperMek-XV.aspx>
- <http://www.hertsdirect.org/docs/pdf/w/cdsub71>
- <http://gajitz.com/now-you-see-it-reverse-printer-zaps-ink-off-of-paper/>

#### Atmosphere

- <http://oscar.iitb.ac.in/OSCARPP/Mechanical%20Engineering/UploadedStoryboards/SME04P0152Thermoacoustic%20refrigeration.ppt>
- [http://www.nccr-must.ch/libraries.files/Laser\\_assisted\\_water\\_condensation\\_in\\_the\\_atmosphere\\_July2012.pdf](http://www.nccr-must.ch/libraries.files/Laser_assisted_water_condensation_in_the_atmosphere_July2012.pdf)
- [www.sciencedirect.com/science/article/pii/S0013468609002254](http://www.sciencedirect.com/science/article/pii/S0013468609002254)
- [www.sciencedirect.com/science/article/pii/S138358661100445X](http://www.sciencedirect.com/science/article/pii/S138358661100445X)
- [www.google.com/patents/US8256414](http://www.google.com/patents/US8256414)
- [www.fastbrowser.net/Are-IQAir-MPPS-HyperHEPA-eric.htm](http://www.fastbrowser.net/Are-IQAir-MPPS-HyperHEPA-eric.htm)
- [iopscience.iop.org/0022-3727/38/4/007](http://iopscience.iop.org/0022-3727/38/4/007)
- [www.slideshare.net/Nimalan\\_I/thermoacoustic-refrigeration](http://www.slideshare.net/Nimalan_I/thermoacoustic-refrigeration)
- [www.google.com/patents/US5300750](http://www.google.com/patents/US5300750)
- [science.howstuffworks.com/cloud-seeding1.htm](http://science.howstuffworks.com/cloud-seeding1.htm)

#### Agriculture

- <http://books.google.co.in/books?hl=en&lr=&id=FjreD88VN74C&oi=fnd&pg=PA292&dq=in-vitro-meat&ots=MVdlwabOgb&sig=4rrqxLtsKP2EG8pQYA X0wfPxSVA>
- <http://www.google.com/patents?hl=en&lr=&vid=USPAT5405905&id=DakjAAAAEBAJ&oi=fnd&dq=composition+of+artificial+soil&printsec=abstract#v=onepage&q=composition%20of%20artificial%20soil&f=false>
- <http://www.hydroponics-simplified.com/hydroponic-drip-system.html>
- <http://www.gardena.com/uk/water-management/micro-drip-irrigation-system/>
- <http://nawazagriengineering.blogspot.in/2009/10/figures-shows-different-types-of.html>

#### Communication

- <http://thesis.library.caltech.edu/2439/>
- <http://physicsworld.com/cws/article/news/2012/mar/19/neutrino-based-communication-is-a-first>
- <http://www.centauri-dreams.org/?p=22593>
- <http://www.forbes.com/sites/brucedorminey/2012/04/30/neutrinos-to-give-high-frequency-traders-the-millisecond-edge/>
- <http://www.aapm.org/meetings/05AM/pdf/18-4016-65735-22.pdf>
- [http://www.ehow.com/how-does\\_4609129\\_how-proton-beam-created.html](http://www.ehow.com/how-does_4609129_how-proton-beam-created.html)
- [http://ieeexplore.ieee.org/xpl/login.jsp?tp=&arnumber=4590980&url=http%3A%2F%2Fieeexplore.ieee.org%2Fxppls%2Fabs\\_all.jsp%3Farnumber%3D4590980](http://ieeexplore.ieee.org/xpl/login.jsp?tp=&arnumber=4590980&url=http%3A%2F%2Fieeexplore.ieee.org%2Fxppls%2Fabs_all.jsp%3Farnumber%3D4590980)
- <http://www.livescience.com/19075-neutrino-particle-communications-message.html>
- [http://www.maik.ru/full/lasphys/05/12/lasphys12\\_05p1710full.pdf](http://www.maik.ru/full/lasphys/05/12/lasphys12_05p1710full.pdf)
- [http://pop.aip.org/resource/1/phpaen/v15/i5/p053104\\_s1?isAuthorized=no](http://pop.aip.org/resource/1/phpaen/v15/i5/p053104_s1?isAuthorized=no)
- <http://connection.ebscohost.com/c/articles/32509473/efficient-production-collimated-mev-proton-beam-from-polyimide-target-driven-by-intense-femtosecond-laser-pulse>

#### Transportation

- <http://www.dcr.net/~stickmak/JOHT/fisfus.xls>
- <http://www.dcr.net/~stickmak/JOHT/propella.xls>

#### Recreation

- <http://virtual-dio.com/img/odt-scene.jpg>
- <http://i19.beon.ru/63/55/5563/89/71189/>